

WT68

YALITIMLI KAPI-PENCERE SİSTEMİ
THERMAL WINDOW&DOOR SYSTEM

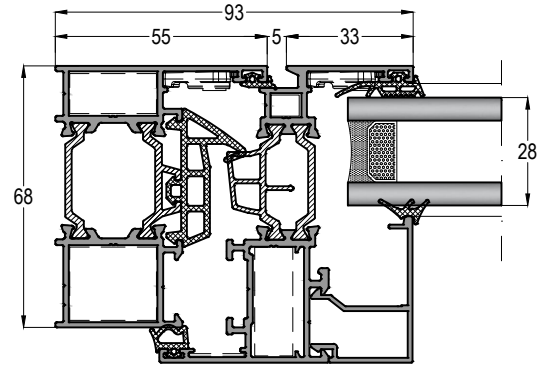
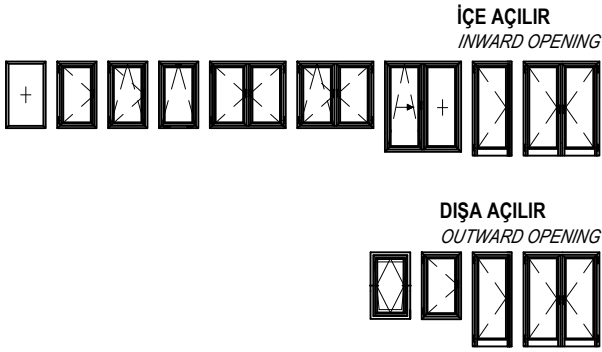

KASA GENİŞLİĞİ : 68 mm
Frame Width

SİSTEM ET KALINLIĞI : 1,4 mm
System Wall Thickness

ISI BARIYERİ : 30 mm
Insulation Barrier

CAM KALINLIĞI : 20 - 53 mm
Glass Thickness

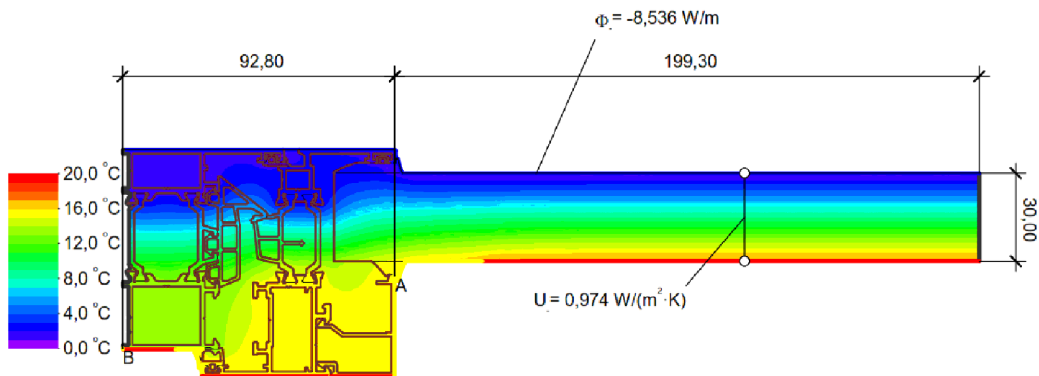

$$U_{fAB} = \frac{\frac{\Phi}{\Delta T} - U_p \cdot b_p}{b_f} = \frac{\frac{8,536}{20,000} - 0,974 \cdot 0,199}{0,093} = 2,51 \text{ W/(m}^2 \cdot \text{K)}$$

Uf değeri cam Ug değerine göre değişkenlik gösterir. Cam Ug değeri 1-0,9 W/m2K olan bir ünite de Uw değeri < 2 W/m2K olabilir
Uf value can be change according to the glass Ug value. If the glass Ug value is 1-0,9 W/m2K, Uw value can be < 2 W/m2K

WT 68

YALITIMLI KAPI-PENCERE SİSTEMİ
THERMAL WINDOW&DOOR SYSTEM

ASISTAL

PROFİL VE AKSESUAR LİSTELERİ
PROFILE & ACCESSORIES LISTS



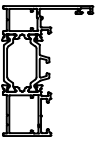
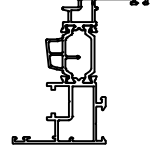
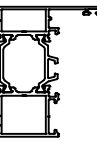
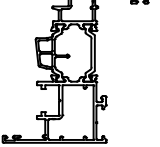
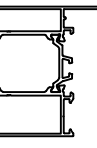
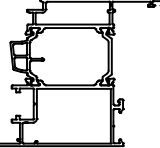
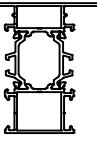
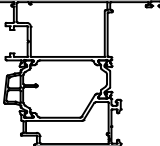
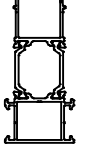
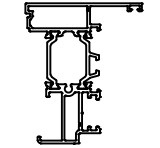
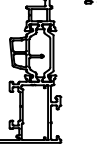
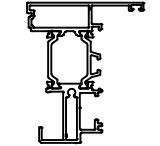
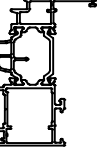
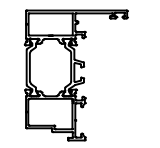
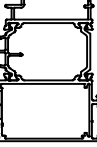
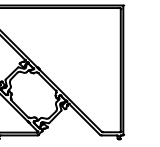
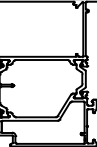
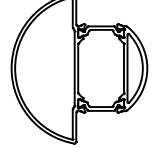
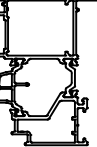







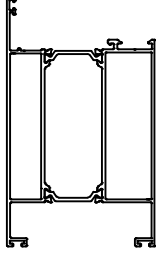

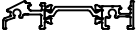





PROFİL LİSTESİ - PROFILES LIST

WT68 01	Jx cm ⁴	Jy cm ⁴		WT68 M10	Jx cm ⁴	Jy cm ⁴	
	22,66	4,69			40,09	7,07	
KASA PROFİLİ-47 mm FRAME PROFILE	AĞIRLIK / Weight			KANAT PROFİLİ İSPANYOLET KİLİTLEME SASH PROFILE-MULTI POINT	AĞIRLIK / Weight		
	1,171 kg/mt				1,454 kg/mt		
WT68 02	Jx cm ⁴	Jy cm ⁴		WT68 M11	Jx cm ⁴	Jy cm ⁴	
	24,81	6,56			42,39	9,84	
KASA PROFİLİ-55 mm FRAME PROFILE	AĞIRLIK / Weight			KANAT PROFİLİ İSPANYOLET KİLİTLEME SASH PROFILE-MULTI POINT	AĞIRLIK / Weight		
	1,285 kg/mt				1,565 kg/mt		
WT68 03	Jx cm ⁴	Jy cm ⁴		WT68 M12	Jx cm ⁴	Jy cm ⁴	
	33,30	20,78			57,34	29,04	
KASA PROFİLİ-70 mm FRAME PROFILE	AĞIRLIK / Weight			İÇE AÇILIR KAPI KANAT PROFİLİ-İSPANYOLET KİL INWARD OPENING DOOR SASH PROFILE-MULTI POINT	AĞIRLIK / Weight		
	1,558 kg/mt				1,907 kg/mt		
WT68 21	Jx cm ⁴	Jy cm ⁴		WT68 M13	Jx cm ⁴	Jy cm ⁴	
	29,41	12,58			50,63	32,56	
ORTA KAYIT PROFİLİ TRANSOM-MULLION PROFILE Körkasa	AĞIRLIK / Weight			DIŞA AÇILIR KAPI KANAT PROFİLİ-İSPANYOLET KİL OUTWARD OPENING DOOR SASH PROFILE-MULTI POINT	AĞIRLIK / Weight		
	1,499 kg/mt				2,026 kg/mt		
WT68 22	Jx cm ⁴	Jy cm ⁴		WT68 41	Jx cm ⁴	Jy cm ⁴	
	39,96	13,86			30,28	7,74	
KANAT İÇİ ORTA KAYIT PROFİLİ TRANSOM-MULLION PROFILE FOR SASH PROFILES	AĞIRLIK / Weight			ÇİFT KANAT ADAPTÖR PROFİLİ DOUBLE SASH ADAPTER PROFILE	AĞIRLIK / Weight		
	1,467 kg/mt				1,468 kg/mt		
WT68 10	Jx cm ⁴	Jy cm ⁴		WT68 42	Jx cm ⁴	Jy cm ⁴	
	36,92	5,18			31,88	7,57	
KANAT PROFİLİ SASH PROFILE	AĞIRLIK / Weight			ÇİFT KANAT ADAPTÖR PROFİLİ-MULTI POINT DOUBLE SASH ADAPTER PROFILE - MULTI POINT	AĞIRLIK / Weight		
	1,329 kg/mt				1,514 kg/mt		
WT68 11	Jx cm ⁴	Jy cm ⁴		WT68 43	Jx cm ⁴	Jy cm ⁴	
	43,43	10,47			21,98	6,03	
KANAT PROFİLİ SASH PROFILE	AĞIRLIK / Weight			DIŞA AÇILIR KAPI ADAPTÖR PROFİLİ OUTWARD OPENING DOOR ADAPTER PROFILE	AĞIRLIK / Weight		
	1,535 kg/mt				1,253 kg/mt		
WT68 12	Jx cm ⁴	Jy cm ⁴		WT68 50	Jx cm ⁴	Jy cm ⁴	
	60,92	32,33			34,43	32,70	
İÇE AÇILIR KAPI KANAT PROFİLİ INWARD OPENING DOOR SASH PROFILE	AĞIRLIK / Weight			90° KÖŞE PROFİLİ CORNER PROFILE	AĞIRLIK / Weight		
	1,921 kg/mt				1,641 kg/mt		
WT68 13	Jx cm ⁴	Jy cm ⁴		TH68 52	Jx cm ⁴	Jy cm ⁴	
	52,97	42,74			30,21	29,52	
DIŞA AÇILIR KAPI KANAT PROFİLİ OUTWARD OPENING DOOR SASH PROFILE	AĞIRLIK / Weight			EKSENEL DÖNÜŞ PROFİLİ CORNER PROFILE	AĞIRLIK / Weight		
	2,021 kg/mt				1,719 kg/mt		
WT68 14	Jx cm ⁴	Jy cm ⁴					
	44,85	23,11					
DIŞA AÇILIR PENCERE KANAT PROFİLİ OUTWARD OPENING DOOR SASH PROFILE	AĞIRLIK / Weight						
	1,788 kg/mt						

Profil ağırlıklarımız teorik olup; teslim anındaki tartımız geçerlidir.

Profile weights are theoretical and the weight at the time of delivery is valid.









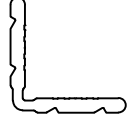

PROFİL LİSTESİ - PROFILES LIST

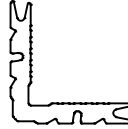
WT68 31		Jx cm ⁴ 128,84	Jy cm ⁴ 77,79		11-004		
Etek Profili-108 mm BOTTOM PLATE PROFILE		AĞIRLIK / Weight 2,660 kg/mt			CAM ÇİTASI-4 mm GLAZING BEAD PROFILE		
					11-006		
				CAM ÇİTASI-6 mm GLAZING BEAD PROFILE		AĞIRLIK / Weight 0,218 kg/mt	
WT68 32					11-010		
Eşik Profili BOTTOM RAIL PROFILE		AĞIRLIK / Weight 0,675 kg/mt			CAM ÇİTASI-10 mm GLAZING BEAD PROFILE		
12-7701					11-015		
DİK BAĞLANTI PROFİLİ T CONNECTIONS PROFILE OUTSIDE		AĞIRLIK / Weight 1,041 kg/mt			CAM ÇİTASI-15 mm GLAZING BEAD PROFILE		
12-7702					11-017		
DİK BAĞLANTI PROFİLİ T CONNECTIONS PROFILE INSIDE		AĞIRLIK / Weight 0,461 kg/mt			CAM ÇİTASI-17 mm GLAZING BEAD PROFILE		
12-7703					11-020		
DAMLALIK PROFİLİ RAINDROP PROFILE		AĞIRLIK / Weight 0,421 kg/mt			CAM ÇİTASI-20 mm GLAZING BEAD PROFILE		
12-7704					11-022		
ADAPTÖR PROFİLİ ADAPTER PROFILE		AĞIRLIK / Weight 0,164 kg/mt			CAM ÇİTASI-22 mm GLAZING BEAD PROFILE		
12-02					11-026		
DAMLALIK PROFİLİ RAINDROP PROFILE		AĞIRLIK / Weight 0,136 kg/mt			CAM ÇİTASI-26 mm GLAZING BEAD PROFILE		
12-41					11-028		
TİJ PROFİLİ GLAZING BEAD PROFILE		AĞIRLIK / Weight 0,118 kg/mt			CAM ÇİTASI-28 mm GLAZING BEAD PROFILE		
68-G01					11-030		
CAM TAKOZ PROFİLİ GLASS SUPPORT PROFILE		AĞIRLIK / Weight 0,369 kg/mt			CAM ÇİTASI-30 mm GLAZING BEAD PROFILE		

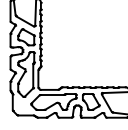



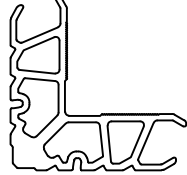

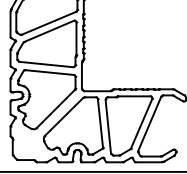
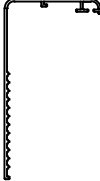
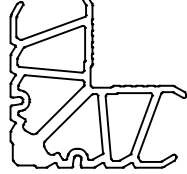





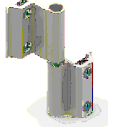

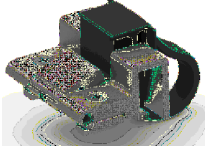

Profil ağırlıklarımız teorik olup; teslim anındaki tartımız geçerlidir.

Profile weights are theoretical and the weight at the time of delivery is valid.

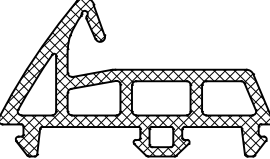

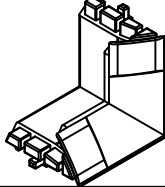
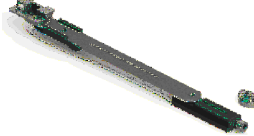

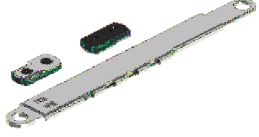

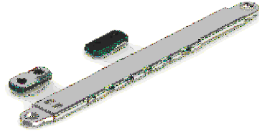





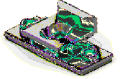

PROFİL LİSTESİ - PROFILES LIST

11-032			10-010075-00		
CAM ÇİTASI-32 mm GLAZING BEAD PROFILE	AĞIRLIK / Weight 0,315 kg/mt		KÖŞE TAKOZU-7,5 mm CORNER JOINT	AĞIRLIK / Weight 2,009 kg/m	
11-035			10-010106-00		
CAM ÇİTASI-35 mm GLAZING BEAD PROFILE	AĞIRLIK / Weight 0,323 kg/mt		KÖŞE TAKOZU-10,6 mm CORNER JOINT	AĞIRLIK / Weight 2,653 kg/mt	
11-038			FC10-158-00		
CAM ÇİTASI-38 mm GLAZING BEAD PROFILE	AĞIRLIK / Weight 0,333 kg/mt		KÖŞE TAKOZU-15,8 mm CORNER JOINT	AĞIRLIK / Weight 2,566 gr/m	
11-040			10-010225-00		
CAM ÇİTASI-40 mm GLAZING BEAD PROFILE	AĞIRLIK / Weight 0,325 kg/mt		KÖŞE TAKOZU-22,5 mm CORNER JOINT	AĞIRLIK / Weight 3,564 kg/mt	
11-044			10-010294-00		
CAM ÇİTASI-44 mm GLAZING BEAD PROFILE	AĞIRLIK / Weight 0,339 kg/mt		KÖŞE TAKOZU-29,4 mm CORNER JOINT	AĞIRLIK / Weight 4,825 kg/mt	
12-54			10-010382-00		
PERVAZ PROFİLİ BORDER PROFILE	AĞIRLIK / Weight 0,326 kg/mt		KÖŞE TAKOZU-38,2 mm CORNER JOINT	AĞIRLIK / Weight 5,255 kg/mt	
12-94			10-010429-00		
PERVAZ PROFİLİ BORDER PROFILE	AĞIRLIK / Weight 0,602 kg/mt		KÖŞE TAKOZU-42,7 mm CORNER JOINT	AĞIRLIK / Weight 5,483 kg/mt	

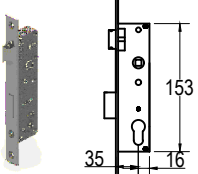
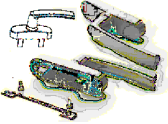
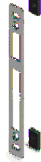

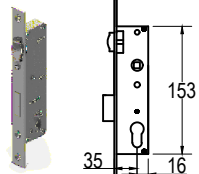
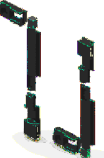

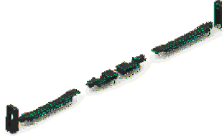
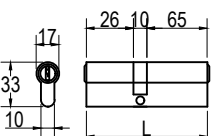
AKSESUAR LİSTESİ - ACCESSORIES LIST

EPW1-01			ASI-F 100A		
DİŞ CAM FİTİLİ - 3 mm <i>OUTER GLAZING GASKET</i>	KOLİ MİKTARI/Package 625 mt / 15 kg		KAPI ALTI FIRÇASI <i>DOOR BRUSH GASKET</i>	KOLİ MİKTARI/Package Adet / Piece	
EP2-01			ASI-H 9730		
İÇ CAM FİTİLİ - 3 mm <i>INNER GLAZING GASKET</i>	KOLİ MİKTARI/Package 440 mt / 15 kg		SİSTEM İKİLİ MENTEŞE <i>DOUBLE SYSTEM HINGE</i>	KOLİ MİKTARI/Package 250 Adet / Piece	
EP2-02			ASI-H 9733		
İÇ CAM FİTİLİ - 4 mm <i>INNER GLAZING GASKET</i>	KOLİ MİKTARI/Package 300 mt / 15 kg		SİSTEM ÜÇLÜ MENTEŞE <i>TRIPLE SYSTEM HINGE</i>	KOLİ MİKTARI/Package 250 Adet / Piece	
EP2-03			ASI-H 3300		
İÇ CAM FİTİLİ - 5 mm <i>INNER GLAZING GASKET</i>	KOLİ MİKTARI/Package 250 mt / 15 kg		SİSTEM KAPI MENTEŞESİ <i>SYSTEM DOOR HINGE</i>	KOLİ MİKTARI/Package Adet / Piece	
EPW3-01			ASI-V 820		
KASA BİNİ FİTİLİ <i>FRAME GASKET</i>	KOLİ MİKTARI/Package 750 mt / 15 kg		VASİSTAS AÇILIM KOLU <i>TRANSOM OPENING HANDLE</i>	KOLİ MİKTARI/Package 30 Adet / Piece	
EPW3-02			ASI-V 816		
KANAT BİNİ FİTİLİ <i>SASH GASKET</i>	KOLİ MİKTARI/Package 275 mt / 15 kg		VASİSTAS AÇILIM KOLU <i>TRANSOM OPENING HANDLE</i> MULTIPOINT	KOLİ MİKTARI/Package 50 Adet / Piece	
EPW3-04			ASI-V 1000		
ORTA BİNİ FİTİLİ <i>GASKET FOR OPEN JOINT</i>	KOLİ MİKTARI/Package 50 mt / 15 kg		VASİSTAS MAKAS (PVC) <i>TRANSOM RESTRICTER</i>	KOLİ MİKTARI/Package 120 Adet / Piece	
EPW3-04K			ASI-V 1080		
VULKANİZE FİTİLİ <i>GASKET FOR CORNER</i>	KOLİ MİKTARI/Package Adet / Piece		VASİSTAS MAKAS <i>TRANSOM RESTRICTER</i>	KOLİ MİKTARI/Package 60 Adet / Piece	
EPW4-02			ASI-V 1275-3		
EŞİK FİTİLİ <i>BOTTOM RAIL GASKET</i>	KOLİ MİKTARI/Package mt / 15 kg		VASİSTAS 3 KADEMELİ ÇELİK MAKAS <i>TRANSOM RESTRICTER</i> WITH 3 POSITIONS	KOLİ MİKTARI/Package 10 Adet / Piece	
KF 67-1000			ASI-V 1275-5		
FIRÇA FİTİL <i>BRUSH GASKET</i>	KOLİ MİKTARI/Package 600 mt		VASİSTAS 5 KADEMELİ ÇELİK MAKAS <i>TRANSOM RESTRICTER</i> WITH 5 POSITIONS	KOLİ MİKTARI/Package 10 Adet / Piece	

AKSESUAR LİSTESİ - ACCESSORIES LIST

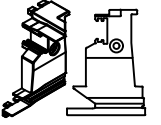
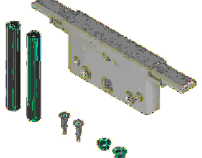
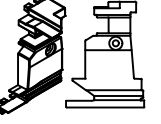
ASI-WH 001			ASI-LTT K01		
KARE MİLLİ PENCERE KOLU WINDOW HANDLE	KOLİ MİKTARI/Package Adet / Piece		ÇİFT KANAT AÇILIM PASİF KANAT LEVYE KOL INACTIVE SASH HIDDEN HANDLE	KOLİ MİKTARI/Package Takım / Set	
ASI-WH 001A			ASI-RS 001		
KARE MİLLİ PENCERE KOLU-ANAHTARLI WINDOW HANDLE WITH LOCK	KOLİ MİKTARI/Package Adet / Piece		PİM KARŞILIĞI ROD PROFILE STRIKES	KOLİ MİKTARI/Package 120 Adet / Piece	
ASI-WH 001B			ASI-RP 001		
KARE MİLLİ PENCERE KOLU - İKİLİ TAKIM WINDOW HANDLE WITH LOCK	KOLİ MİKTARI/Package Takım / Set		TİJ PİMİ ROD PROFILE LOCKING	KOLİ MİKTARI/Package Adet / Piece	
ASI-DH 002			ASI-DH 60Y		
KAPI KOLU DOOR HANDLE	KOLİ MİKTARI/Package Adet / Piece		ÇEKME KAPI KOLU DOOR HANDLE	KOLİ MİKTARI/Package Adet / Piece	
ASI-WH 003			ASI-153 35		
TEK DİLLİ EKSENEL KOL WINDOW HANDLE	KOLİ MİKTARI/Package Adet / Piece		DİLLİ KİLİT MOURTISE LOCK WITH CYLINDER	KOLİ MİKTARI/Package Adet / Piece	
ASI-WH 004			ASI-LS 90185D		
ÇİFT DİLLİ EKSENEL KOL WINDOW HANDLE	KOLİ MİKTARI/Package Adet / Piece		DİLLİ KİLİT KARŞILIĞI LOCK STRIKES	KOLİ MİKTARI/Package Adet / Piece	
ASI-WH 004A			ASI-155 35		
ÇİFT DİLLİ EKSENEL KOL - ANAHTARLI WINDOW HANDLE WITH LOCK	KOLİ MİKTARI/Package Adet / Piece		MAKARALI KİLİT MOURTISE LOCK WITH ROLLER	KOLİ MİKTARI/Package Adet / Piece	
ASI-KA M108			ASI-LS 90185M		
EKSENEL KOL KİLİTLEME MEKANİZMASI LOCKING FOR WINDOW	KOLİ MİKTARI/Package Adet / Piece		MAKARALI KİLİT KARŞILIĞI ROLLER LOCK STRIKES	KOLİ MİKTARI/Package Adet / Piece	
ASI-KA P200			ASI-BRL 101		
EKSENEL KOL KİLİTLEME MEKANİZMASI LOCKING FOR WINDOW	KOLİ MİKTARI/Package Adet / Piece		101 LİK BAREL CYLINDER 101	KOLİ MİKTARI/Package 250 Adet / Piece	
ASI-KA VNT			ASI-225		
KANAT SABİTLEME SASH FIXING	KOLİ MİKTARI/Package Adet / Piece		BAREL AYNASI (Beyaz,Siyah,Gri) DOOR HANDLE CYLINDER (White,Black,Grey)	KOLİ MİKTARI/Package Adet / Piece	

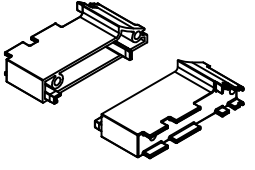
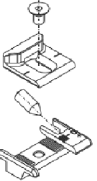
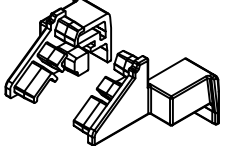
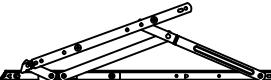

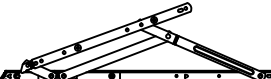
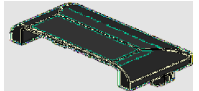
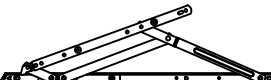
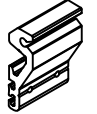
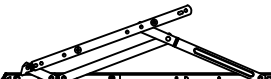
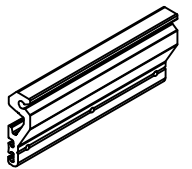
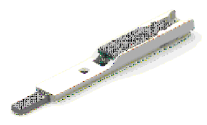
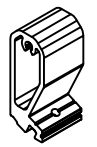
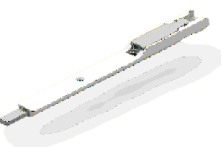
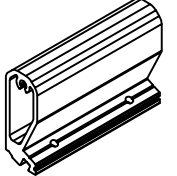

AKSESUAR LİSTESİ - ACCESSORIES LIST

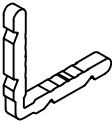
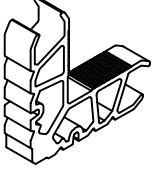
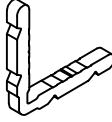
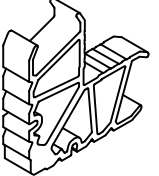
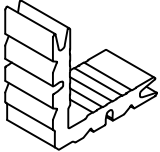
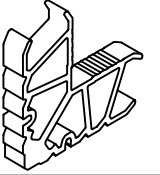
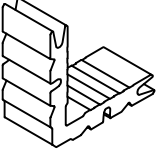
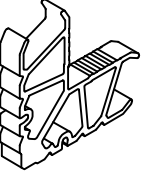
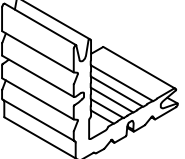
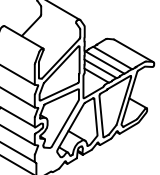
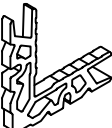
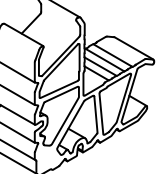
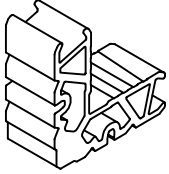
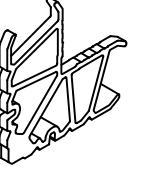
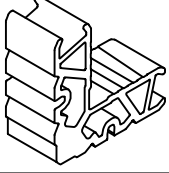
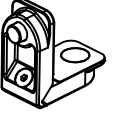
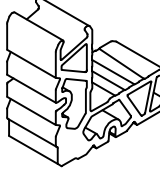
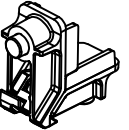
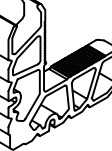
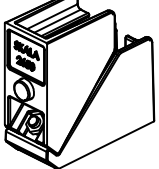
ASI-WH 007			WT68 41HOK		
DIŞA AÇILIR KARE MİLLİ PENCERE KOLU <i>BAS WINDOW HANDLE FOR OUTWARD OPENING</i>	KOLİ MİKTARI/Package Adet / Piece		ADAPTÖR KAPAĞI <i>ADAPTER COVER</i>	KOLİ MİKTARI/Package Alt-üst 1 takım	
ASI-GB 001			WT68 42HOK		
DIŞA AÇILIM KOL MEKANİZMASI <i>LOCKING FOR WINDOW FOR OUTWARD OPENING</i>	KOLİ MİKTARI/Package Adet / Piece		ADAPTÖR KAPAĞI <i>ADAPTER COVER</i>	KOLİ MİKTARI/Package Alt-üst 1 takım	
ASI-RP 002			WT68 -P01		
DIŞA AÇILIM TİJ PİMİ <i>ROD PROFILE LOCKING FOR OUTWARD OPENING</i>	KOLİ MİKTARI/Package Adet / Piece		EŞİK PROFİL KAPAĞI <i>WT68 32 COVER</i>	KOLİ MİKTARI/Package Sağ-Sol 1 takım	
ASI-RS 003			WT77-P02		
DIŞA AÇILIM PİM KARŞILIĞI <i>ROD PROFILE STRIKES FOR OUTWARD OPENING</i>	KOLİ MİKTARI/Package Adet / Piece		DAMLALIK KAPAĞI <i>DROPPER COVER</i>	KOLİ MİKTARI/Package Sağ-Sol 1 takım	
ASI-OA 001			ASI-WDC 01		
DIŞA AÇILIM MAKAS -10" <i>EUROGROVE ARM FOR OUTWARD OPENING</i>	KOLİ MİKTARI/Package Adet / Piece		YAĞMUR TAHLİYE KAPAĞI <i>WATER REJECT COVER</i>	KOLİ MİKTARI/Package Adet / Piece	
ASI-OA 002			ASI-WDC 02		
DIŞA AÇILIM MAKAS -16" <i>EUROGROVE ARM FOR OUTWARD OPENING</i>	KOLİ MİKTARI/Package Adet / Piece		KLAPELİ YAĞMUR TAHLİYE KAPAĞI <i>WATER REJECT COVER</i>	KOLİ MİKTARI/Package Adet / Piece	
ASI-OA 003			ASI-DB 7123		
DIŞA AÇILIM MAKAS -22" <i>EUROGROVE ARM FOR OUTWARD OPENING</i>	KOLİ MİKTARI/Package Adet / Piece		DİK BAĞLANTI <i>T JOINT</i>	KOLİ MİKTARI/Package Adet / Piece	
ASI-OA 004			ASI-DB 7175		
DIŞA AÇILIM MAKAS -28" <i>EUROGROVE ARM FOR OUTWARD OPENING</i>	KOLİ MİKTARI/Package Adet / Piece		DİK BAĞLANTI <i>T JOINT</i>	KOLİ MİKTARI/Package Adet / Piece	
ASI-B 2217			ASI-DB 7222		
SÜRGÜ KİLİTLEME-KISA <i>SASH FIXING LOCK-SHORT</i>	KOLİ MİKTARI/Package 240 Adet / Piece		DİK BAĞLANTI <i>T JOINT</i>	KOLİ MİKTARI/Package Adet / Piece	
ASI-B 2215			ASI-DB 7276		
SÜRGÜ KİLİTLEME-UZUN <i>SASH FIXING LOCK-LONG</i>	KOLİ MİKTARI/Package 120 Adet / Piece		DİK BAĞLANTI <i>T JOINT</i>	KOLİ MİKTARI/Package Adet / Piece	

AKSESUAR LİSTESİ - ACCESSORIES LIST

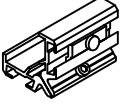
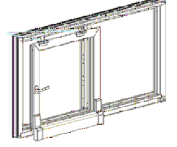
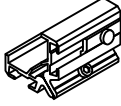
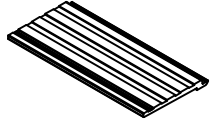
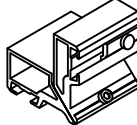
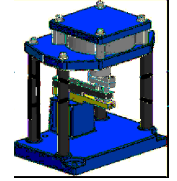
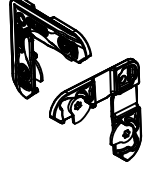
ASI-KT 0806			ASI-KT 2928		
PRES KÖŞE BAĞLANTI <i>CORNER JOINT</i>	KOLİ MİKTARI/Package Adet / Piece		PRES KÖŞE BAĞLANTI <i>CORNER JOINT</i>	KOLİ MİKTARI/Package Adet / Piece	
ASI-KT 1006			ASI-KT 2650		
PRES KÖŞE BAĞLANTI <i>CORNER JOINT</i>	KOLİ MİKTARI/Package Adet / Piece		PRES KÖŞE BAĞLANTI <i>CORNER JOINT</i>	KOLİ MİKTARI/Package Adet / Piece	
ASI-KT 1111			ASI-KT 3806		
PRES KÖŞE BAĞLANTI <i>CORNER JOINT</i>	KOLİ MİKTARI/Package Adet / Piece		PRES KÖŞE BAĞLANTI <i>CORNER JOINT</i>	KOLİ MİKTARI/Package Adet / Piece	
ASI-KT 1119			ASI-KT 3811		
PRES KÖŞE BAĞLANTI <i>CORNER JOINT</i>	KOLİ MİKTARI/Package Adet / Piece		PRES KÖŞE BAĞLANTI <i>CORNER JOINT</i>	KOLİ MİKTARI/Package Adet / Piece	
ASI-KT 1128			ASI-KT 3820		
PRES KÖŞE BAĞLANTI <i>CORNER JOINT</i>	KOLİ MİKTARI/Package Adet / Piece		PRES KÖŞE BAĞLANTI <i>CORNER JOINT</i>	KOLİ MİKTARI/Package Adet / Piece	
ASI-KT 1506			ASI-KT 3828		
PRES KÖŞE BAĞLANTI <i>CORNER JOINT</i>	KOLİ MİKTARI/Package Adet / Piece		PRES KÖŞE BAĞLANTI <i>CORNER JOINT</i>	KOLİ MİKTARI/Package Adet / Piece	
ASI-KT 2311			ASI-KT 4306		
PRES KÖŞE BAĞLANTI <i>CORNER JOINT</i>	KOLİ MİKTARI/Package Adet / Piece		PRES KÖŞE BAĞLANTI <i>CORNER JOINT</i>	KOLİ MİKTARI/Package Adet / Piece	
ASI-KT 2314			ASI-PB 1119		
PRES KÖŞE BAĞLANTI <i>CORNER JOINT</i>	KOLİ MİKTARI/Package Adet / Piece		PİMLİ KÖŞE BAĞLANTI <i>CORNER JOINT</i>	KOLİ MİKTARI/Package Adet / Piece	
ASI-KT 2632			ASI-PB 2632		
PRES KÖŞE BAĞLANTI <i>CORNER JOINT</i>	KOLİ MİKTARI/Package Adet / Piece		PİMLİ KÖŞE BAĞLANTI <i>CORNER JOINT</i>	KOLİ MİKTARI/Package Adet / Piece	
ASI-KT 2906			ASI-PB 2650		
PRES KÖŞE BAĞLANTI <i>CORNER JOINT</i>	KOLİ MİKTARI/Package Adet / Piece		PİMLİ KÖŞE BAĞLANTI <i>CORNER JOINT</i>	KOLİ MİKTARI/Package Adet / Piece	

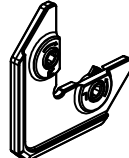
AKSESUAR LİSTESİ - ACCESSORIES LIST

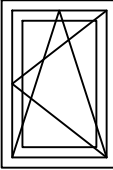
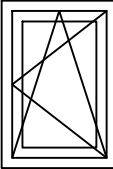
ASI-PB 1128			ASI-MEK VW		
AYARLI PİMLİ KÖŞE BAĞLANTI <i>CORNER JOINT</i>	KOLİ MİKTARI/Package Adet / Piece		PARALEL SÜRME MEKANİZMASI <i>TILT&SLIDE OPENING</i>	KOLİ MİKTARI/Package Takım / Set	
ASI-PB 2811			68-G100		
AYARLI PİMLİ KÖŞE BAĞLANTI <i>CORNER JOINT</i>	KOLİ MİKTARI/Package Adet / Piece		CAM TAKOZU <i>GLAZING SUPPORT</i>	KOLİ MİKTARI/Package Adet / Piece	
ASI-PB 3828			501 EKO PANÇ		
AYARLI PİMLİ KÖŞE BAĞLANTI <i>CORNER JOINT</i>	KOLİ MİKTARI/Package Adet / Piece		KÖŞE PİMLİ BAĞLANTI PANÇ MAKİNESİ <i>PUNCH MACHINE FOR CORNER JOINT WITH PIN</i>	KOLİ MİKTARI/Package Adet / Piece	
ASI-FUJI 2500					
AYARLI ORTA KAYIT BAĞLANTI <i>T JOINT CONNECTION</i>	KOLİ MİKTARI/Package Adet / Piece				
ASI-FUJI 2700					
AYARLI ORTA KAYIT BAĞLANTI <i>T JOINT CONNECTION</i>	KOLİ MİKTARI/Package Adet / Piece				
ASI-FUJI 2000					
AYARLI KÖŞE GÖNYESİ <i>CORNER ALIGNMENT</i>	KOLİ MİKTARI/Package Adet / Piece				
ASI-SB 19.1					
KÖŞE GÖNYESİ <i>CORNER ALIGNMENT</i>	KOLİ MİKTARI/Package 1000 Adet / Piece				
EM 12-54					
PLASTİK KÖŞE BAĞLANTI <i>ALIGNMENT PLASTIC CORNER JOINT</i>	KOLİ MİKTARI/Package Adet / Piece				
ASI-ALU TT					
ÇİFT EKSEN AÇILIM MEKANİZMASI <i>TILT&TURN OPENING</i>	KOLİ MİKTARI/Package Takım / Set				
ASI-PVC TT					
ÇİFT EKSEN AÇILIM MEKANİZMASI <i>TILT&TURN OPENING</i>	KOLİ MİKTARI/Package Takım / Set				

WT 68

YALITIMLI KAPI-PENCERE SİSTEMİ
THERMAL WINDOW&DOOR SYSTEM

ASISTAL



PROFİL DETAYLARI
PROFILE DETAILS

WT68

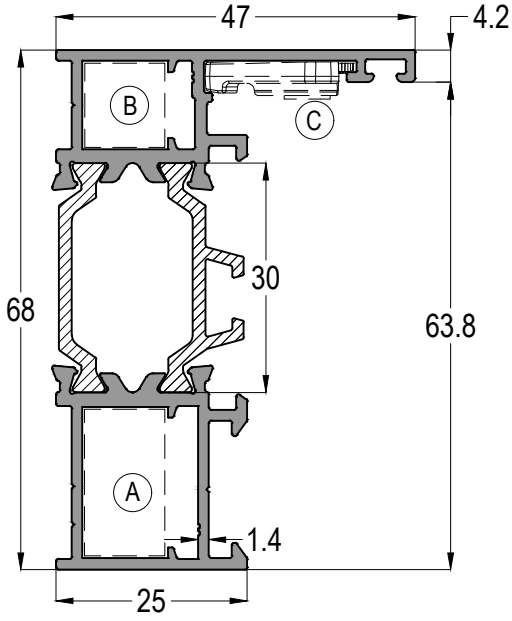

YALITIMLI KAPI-PENCERE SİSTEMİ
THERMAL WINDOW&DOOR SYSTEM

ASISTAL



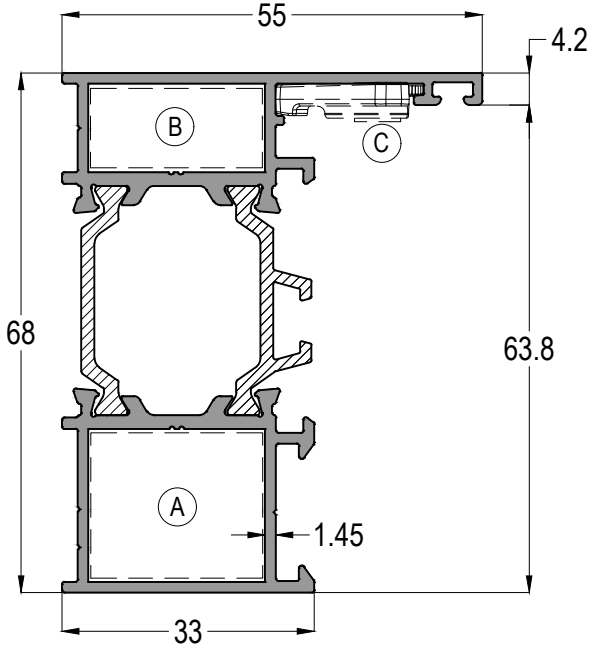

WT68 01	Jx cm ⁴	Jy cm ⁴
	22,66	4,69
  	AĞIRLIK / Weight	
ASI-KT 1119-ASI-PB 1119 ASI-KT 1111 ASI-FUJI 2000	1,171 kg/mt	

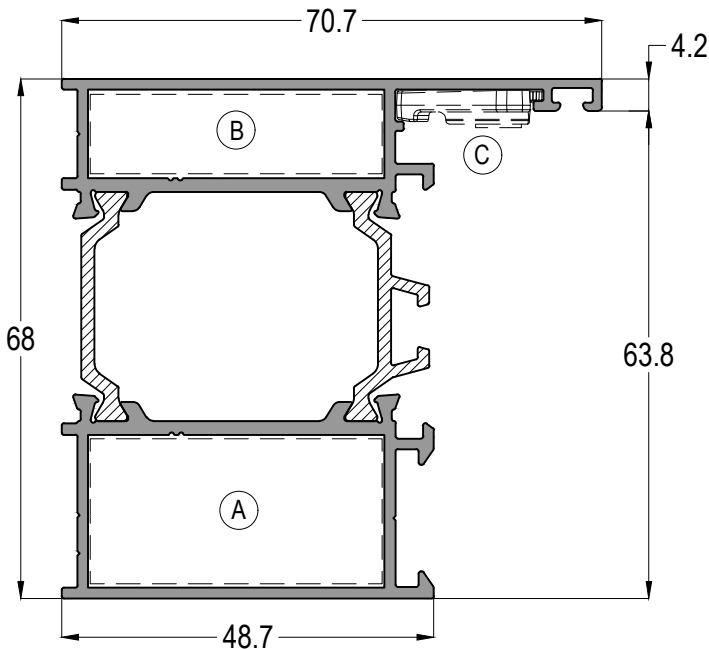

WT68 02	Jx cm ⁴	Jy cm ⁴
	24,81	6,56
  	AĞIRLIK / Weight	
ASI-KT 2632-ASI-PB 2632 ASI-KT 2311 ASI-FUJI 2000	1,285 kg/mt	



WT68 03	Jx cm ⁴	Jy cm ⁴
	33,30	20,78
  	AĞIRLIK / Weight	
ASI-KT 3820 ASI-KT 3811 ASI-FUJI 2000	1,558 kg/mt	

WT68

YALITIMLI KAPI-PENCERE SİSTEMİ
THERMAL WINDOW&DOOR SYSTEM

ASISTAL

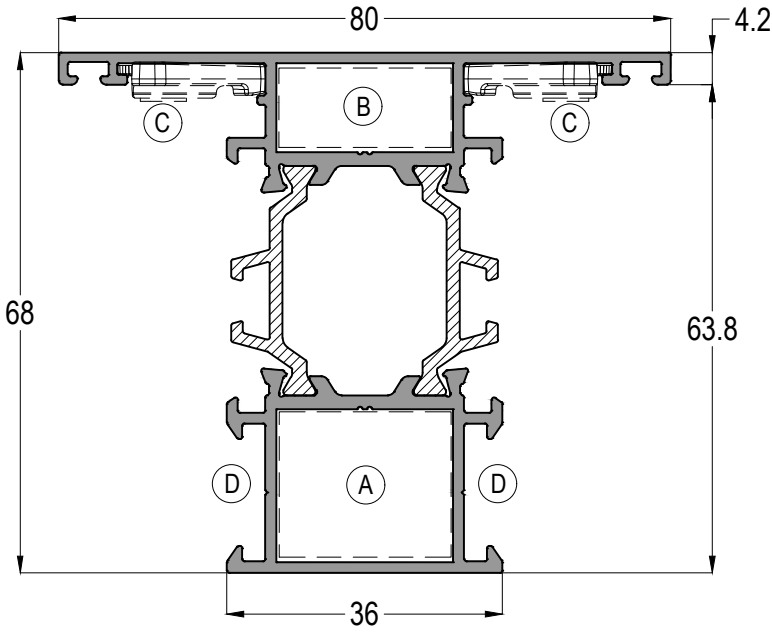

WT68 21				Jx cm ⁴	Jy cm ⁴
				29,41	12,58
AĞIRLIK / Weight					
1,499 kg/mt					
DİK BAĞLANTI TRANSOM / MULLION JOINT					
A	B	C	D		
ASI-KT 2632-ASI-PB 2632	ASI-KT 2311	ASI-FUJJI 2000			
A	D	B	C		
ASI-DB 7222	ASI-FUJJI 2700	ASI-DB 7123	ASI-FUJJI 2400		

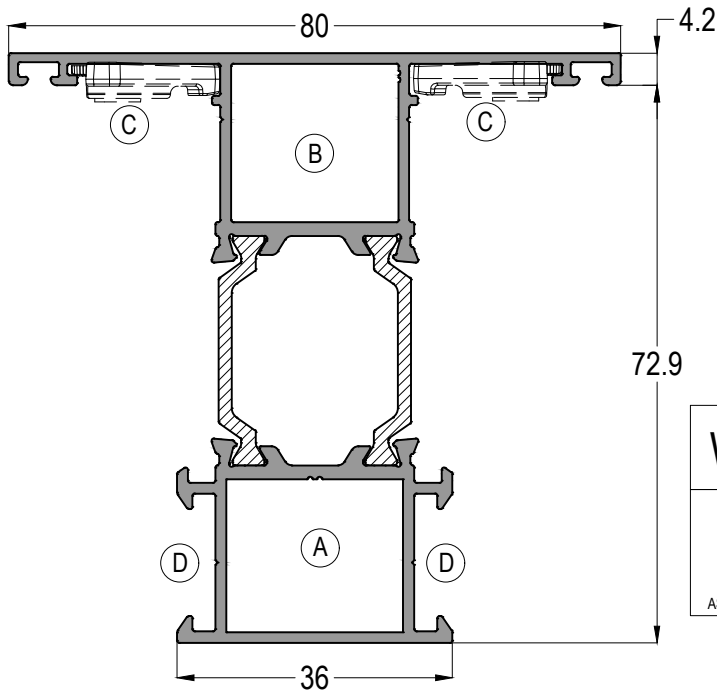

WT68 22				Jx cm ⁴	Jy cm ⁴
				39,96	13,86
AĞIRLIK / Weight					
1,467 kg/mt					
A	D	B	C		
ASI-DB 7222	ASI-FUJJI 2700	ASI-DB 7123	ASI-FUJJI 2400		

WT68

YALITIMLI KAPI-PENCERE SİSTEMİ
THERMAL WINDOW&DOOR SYSTEM

ASISTAL

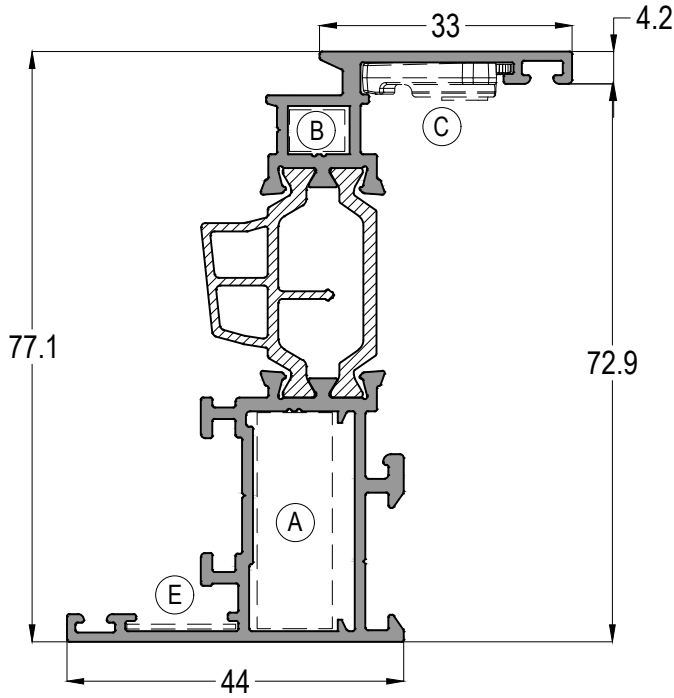

WT68 10		Jx cm ⁴	Jy cm ⁴
		36,92	5,18
		AĞIRLIK / Weight	
		1,329 kg/mt	

A	B	C	E
ASI-KT 1128-ASI-PB 1128	ASI-KT 0806	ASI-FUJI 2000	ASI-SB 19.1

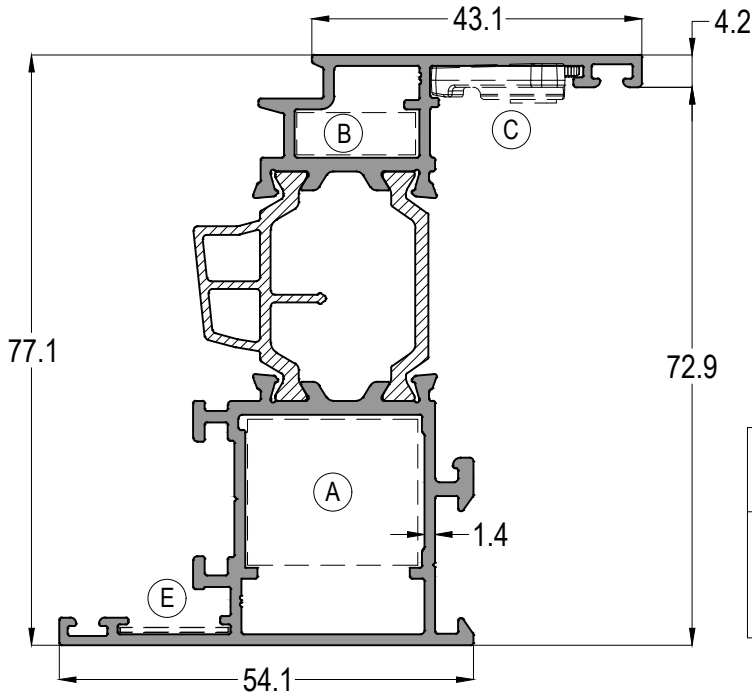

WT68 11		Jx cm ⁴	Jy cm ⁴
		43,43	10,47
		AĞIRLIK / Weight	
		1,535 kg/mt	





A	B	C	E
ASI-KT 2632-ASI-PB 2632	ASI-KT 1506	ASI-FUJI 2000	ASI-SB 19.1

WT68

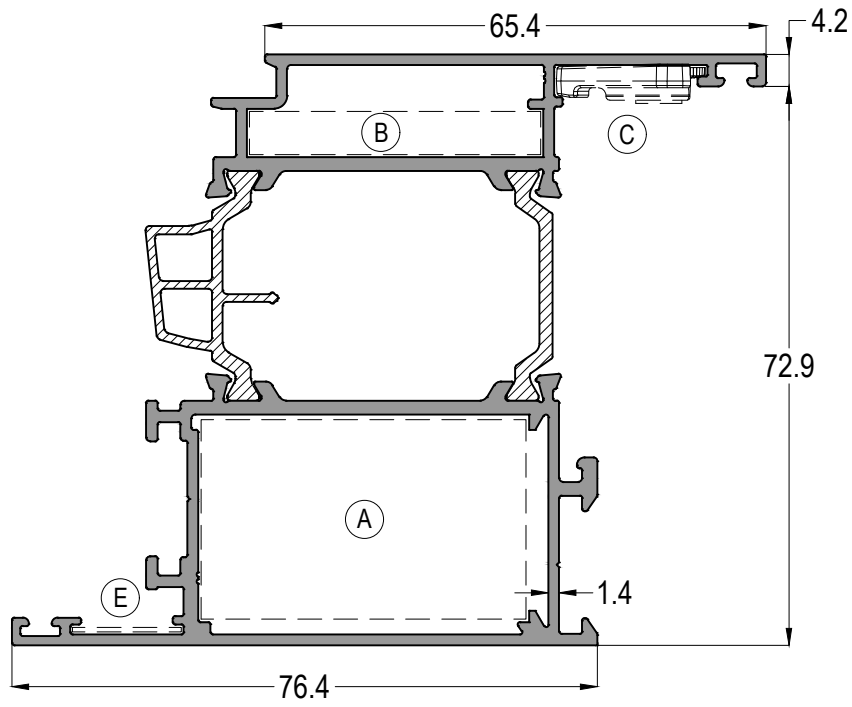
YALITIMLI KAPI-PENCERE SİSTEMİ
THERMAL WINDOW&DOOR SYSTEM

ASISTAL

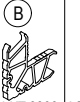





WT68 12				Jx cm ⁴	Jy cm ⁴
				60,92	32,33
				AĞIRLIK / Weight	
ASI-KT 2650-ASI-PB 2650	ASI-KT 3806	ASI-FUJI 2000	ASI-SB 19.1	1,921 kg/mt	

WT68

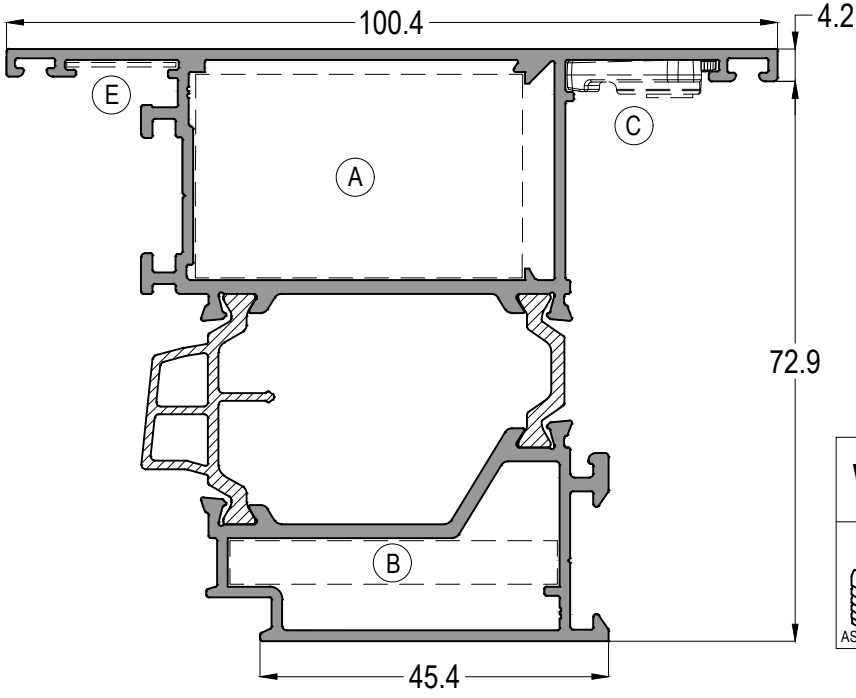



YALITIMLI KAPI-PENCERE SİSTEMİ
THERMAL WINDOW&DOOR SYSTEM

ASISTAL

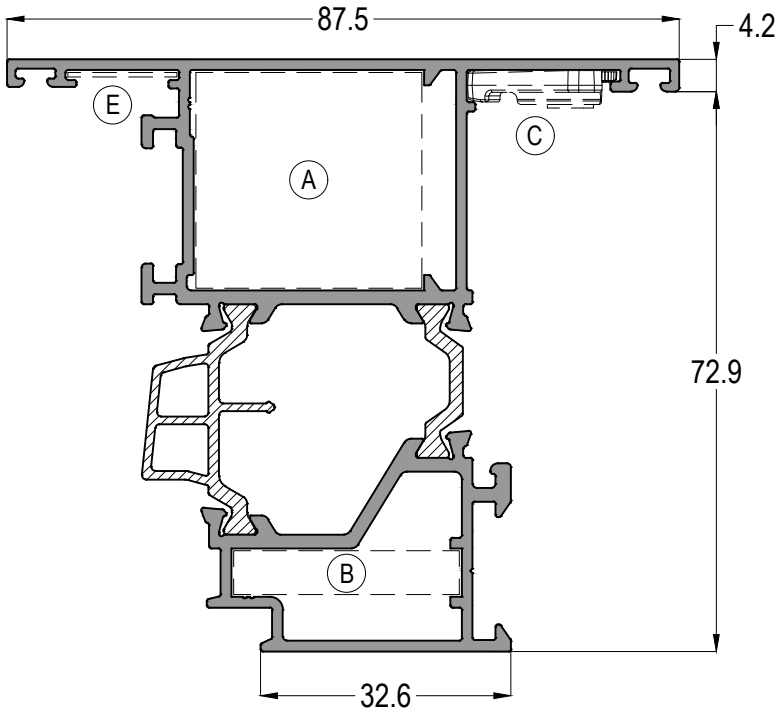

WT68 13				Jx cm ⁴	Jy cm ⁴
				52,97	42,74
				AĞIRLIK / Weight	
ASI-KT 2650-ASI-PB 2650	ASI-KT 4306	ASI-FUJII 2000	ASI-SB 19.1	2,021 kg/mt	







WT68 14				Jx cm ⁴	Jy cm ⁴
				44,85	23,11
				AĞIRLIK / Weight	
ASI-KT 2928	ASI-KT 2906	ASI-FUJII 2000	ASI-SB 19.1	1,788 kg/mt	

WT68

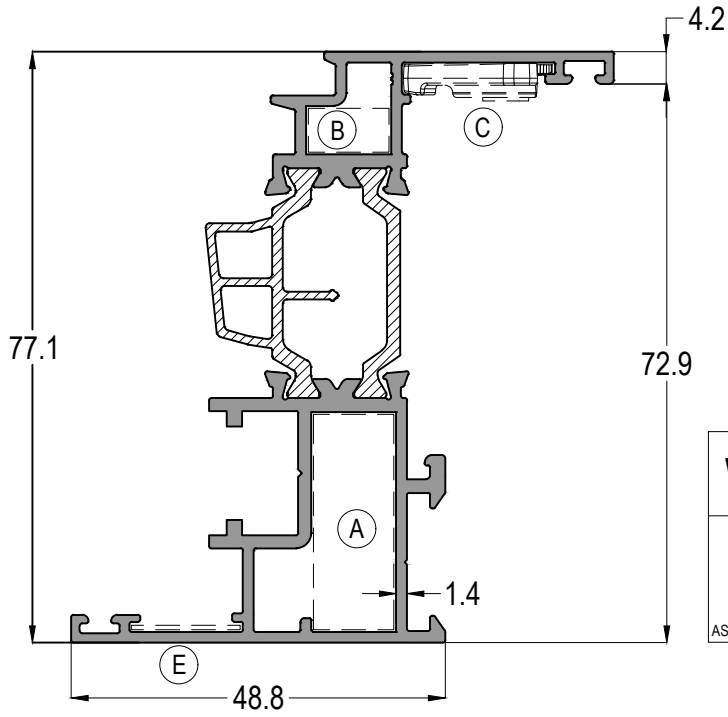

YALITIMLI KAPI-PENCERE SİSTEMİ
THERMAL WINDOW&DOOR SYSTEM

ASISTAL

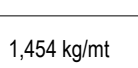

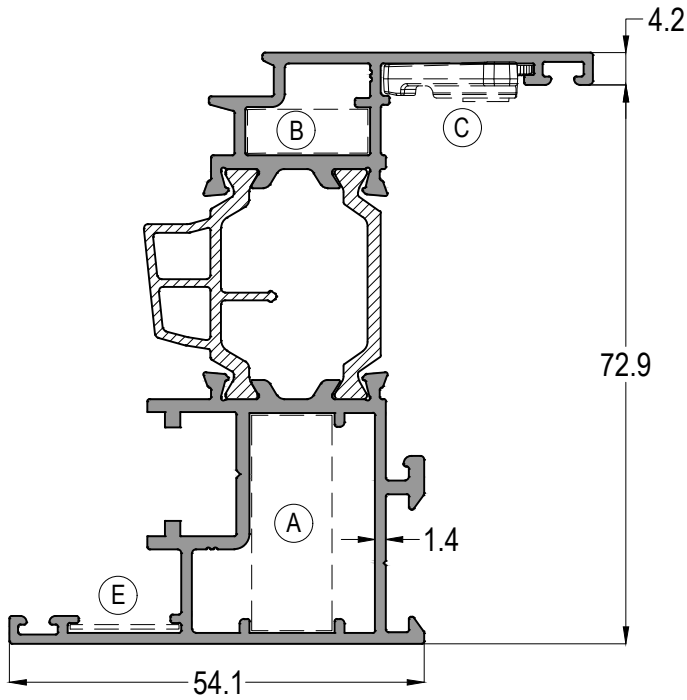
WT68 M10				Jx cm ⁴	Jy cm ⁴
				40,09	7,07
				AĞIRLIK / Weight	
				1,454 kg/mt	
(A)	(B)	(C)	(E)		
					
ASI-KT 1128-ASI-PB 2811	ASI-KT 1006	ASI-FUJJI 2000	ASI-SB 19.1		

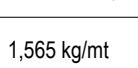

WT68 M11				Jx cm ⁴	Jy cm ⁴
				42,39	9,84
				AĞIRLIK / Weight	
				1,565 kg/mt	
(A)	(B)	(C)	(E)		
					
ASI-KT 1128-ASI-PB 2811	ASI-KT 1506	ASI-FUJJI 2000	ASI-SB 19.1		

WT68

YALITIMLI KAPI-PENCERE SİSTEMİ
THERMAL WINDOW&DOOR SYSTEM

ASISTAL

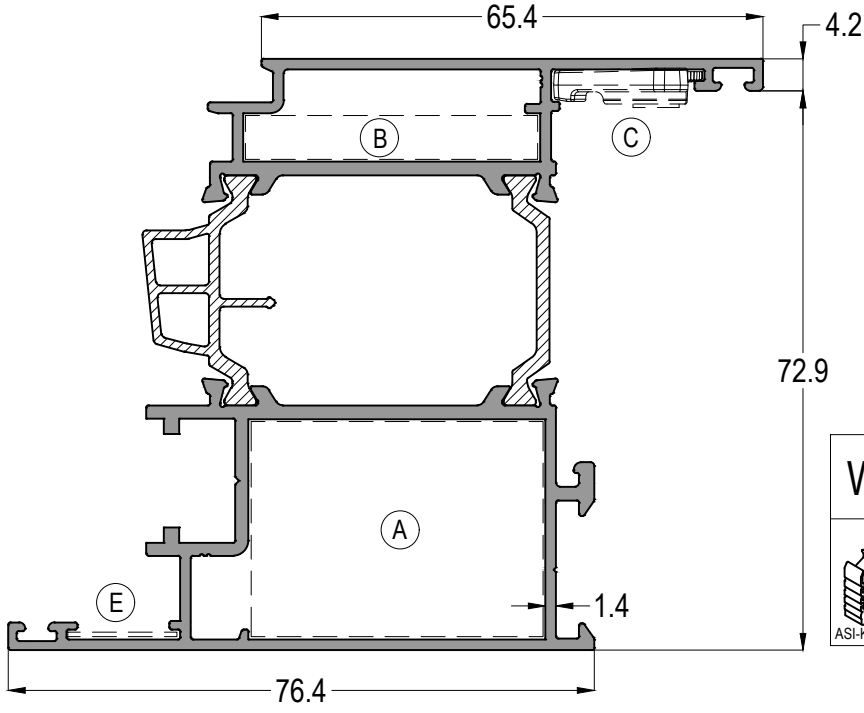

WT68 M12		Jx cm ⁴	Jy cm ⁴
		57,34	29,04
AĞIRLIK / Weight			
1,907 kg/mt			

A	B	C	E
ASI-KT 3828-ASI-PB 3828	ASI-KT 3806	ASI-FUJI 2000	ASI-SB 19.1

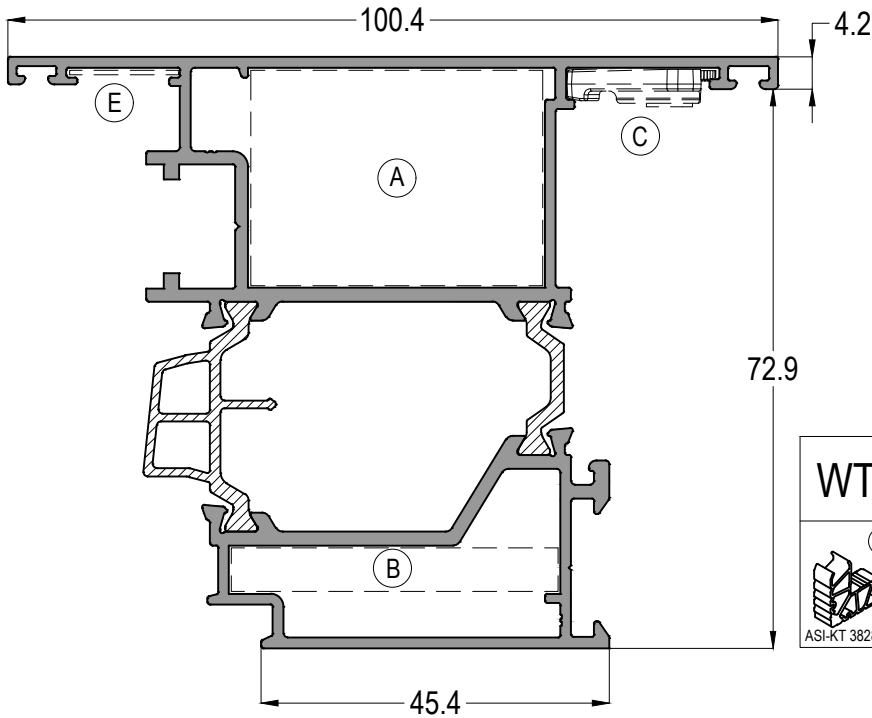

WT68 M13		Jx cm ⁴	Jy cm ⁴
		50,63	32,56
AĞIRLIK / Weight			
2,026 kg/mt			



A	B	C	E
ASI-KT 3828-ASI-PB 3828	ASI-KT 4306	ASI-FUJI 2000	ASI-SB 19.1

WT68

YALITIMLI KAPI-PENCERE SİSTEMİ
THERMAL WINDOW&DOOR SYSTEM

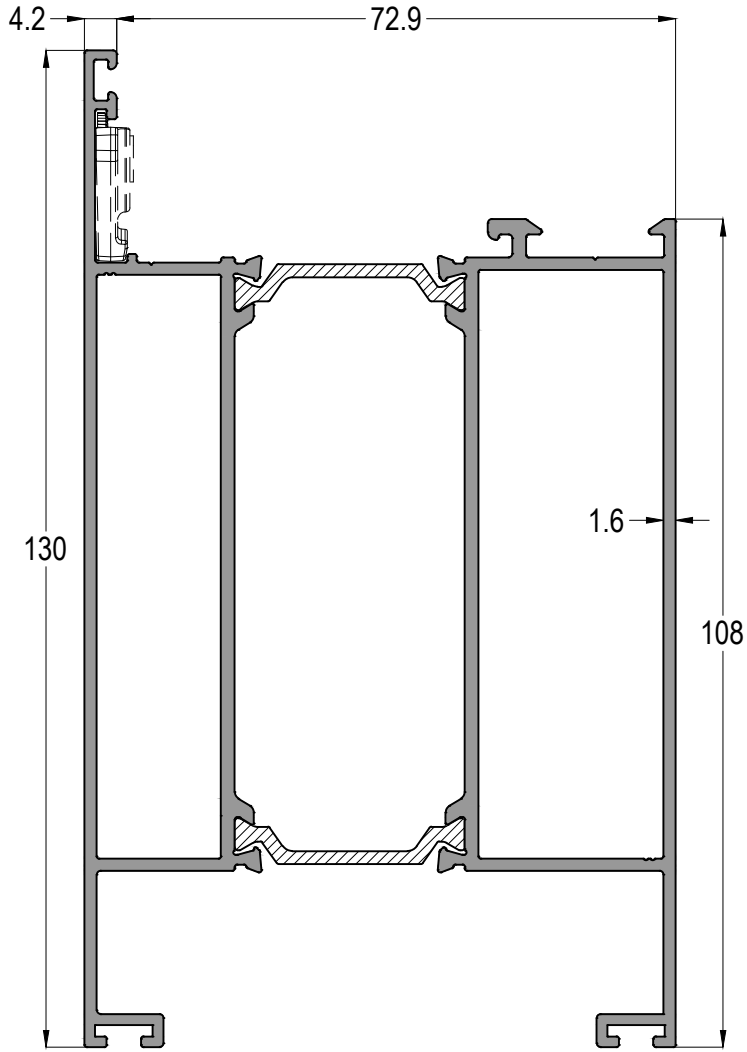
ASISTAL



WT68 31	Jx cm ⁴	Jy cm ⁴
	128,84	77,79
 ASI-FUJI 2700	 ASI-FUJI 2400	AĞIRLIK / Weight
		2,660 kg/mt

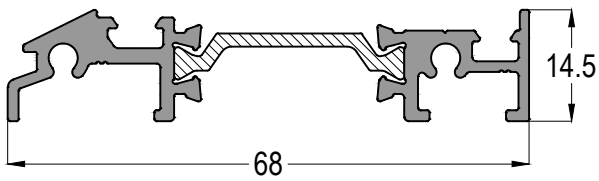

WT68 32

0,675 kg/mt

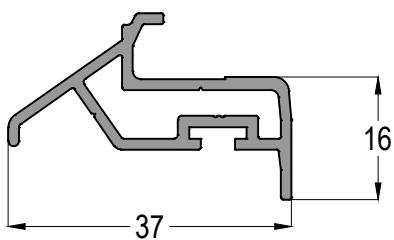

12-7703

0,420 kg/mt

WT68

YALITIMLI KAPI-PENCERE SİSTEMİ
THERMAL WINDOW&DOOR SYSTEM

ASISTAL

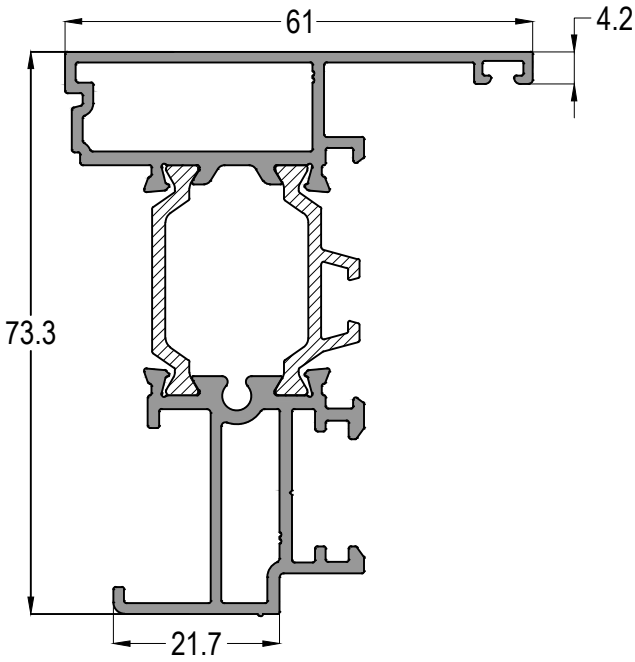

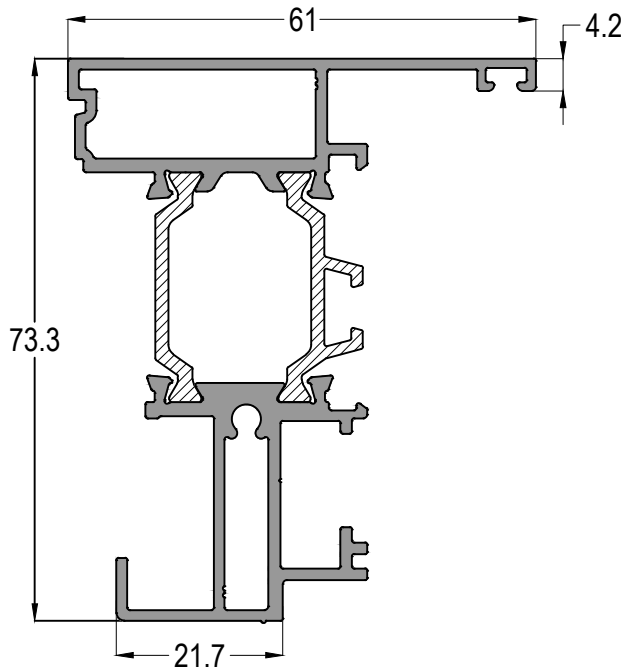

WT68 41	Jx cm ⁴	Jy cm ⁴
	30,28	7,74
	AĞIRLIK / Weight	
	1,468 kg/mt	

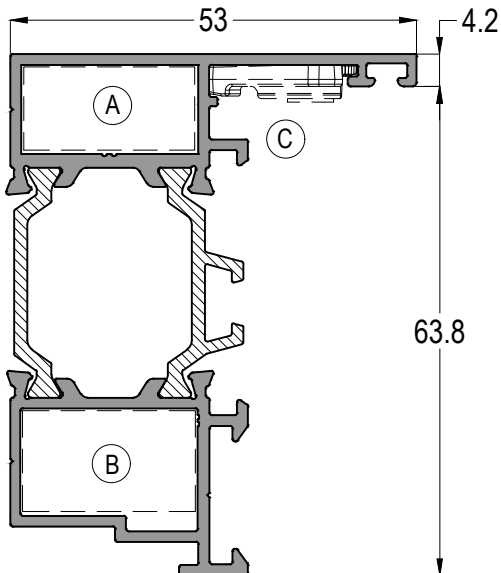

WT68 42	Jx cm ⁴	Jy cm ⁴
	31,88	7,57
	AĞIRLIK / Weight	
	1,514 kg/mt	



WT68 43	Jx cm ⁴	Jy cm ⁴	
	21,98	77,79	
 ASI-KT 2311	 ASI-KT 2314	 ASI-FUJI 2000	AĞIRLIK / Weight
			1,253 kg/mt

WT68

YALITIMLI KAPI-PENCERE SİSTEMİ
THERMAL WINDOW&DOOR SYSTEM

ASISTAL

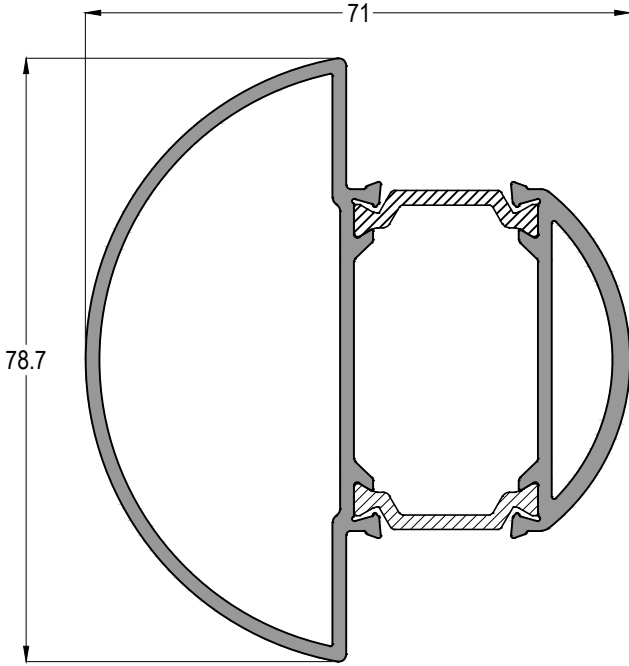

TH68 52	Jx cm ⁴	Jy cm ⁴
	30,21	29,52
AĞIRLIK / Weight		
1,719 kg/mt		

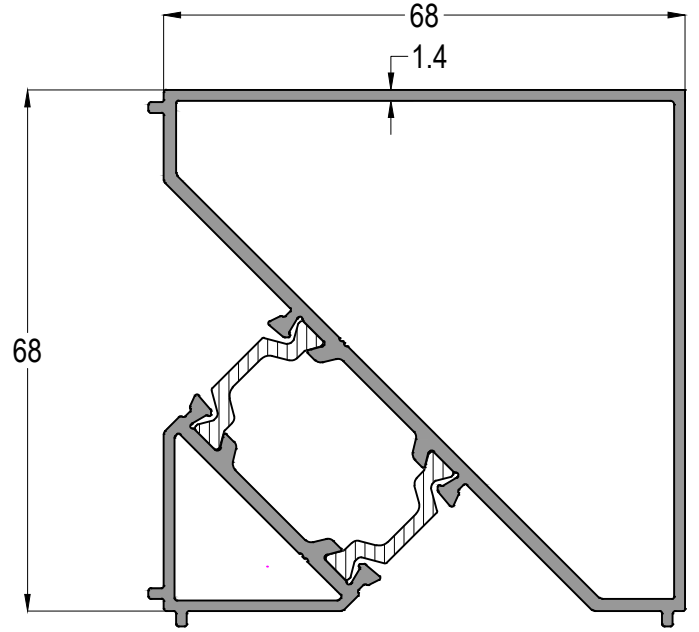

WT68 50	Jx cm ⁴	Jy cm ⁴
	34,43	32,70
AĞIRLIK / Weight		
1,641 kg/mt		

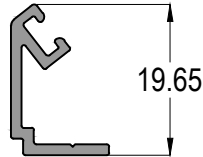

12-7702
0,158 kg/mt

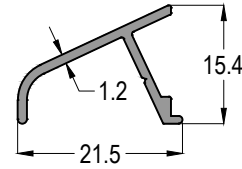

12-02
0,136 kg/mt

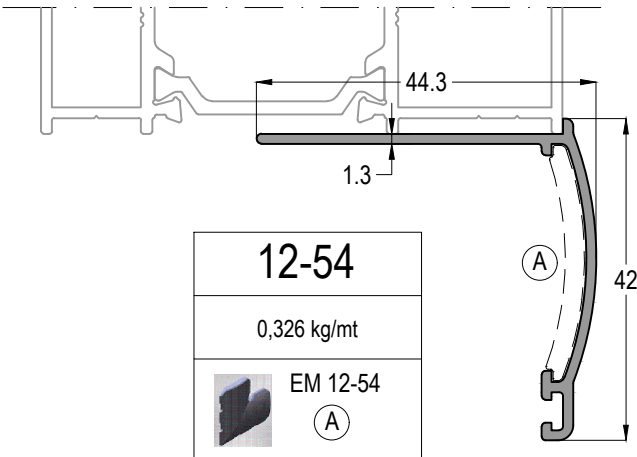

12-54
0,326 kg/mt
 EM 12-54
(A)

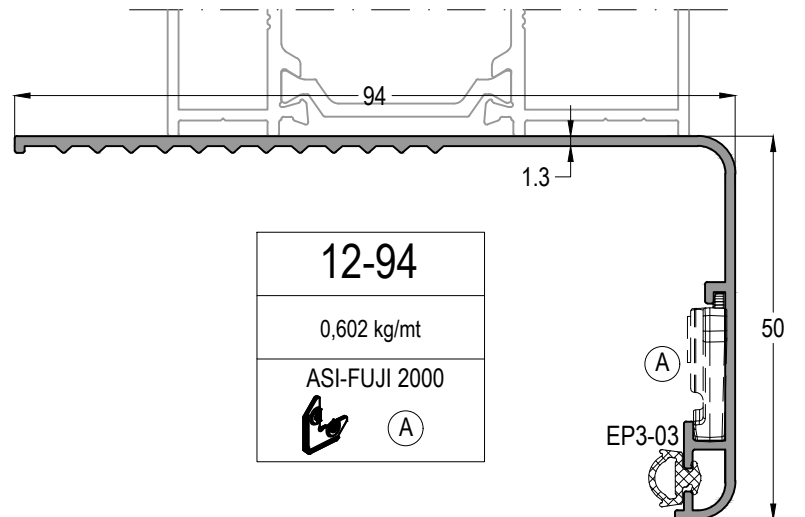

12-94
0,602 kg/mt
ASI-FUJI 2000
 (A)

Profil ağırlıklarımız teorik olup; teslim anındaki tartımız geçerlidir.
Profile weights are theoretical and the weight at the time of delivery is valid.

WT68

YALITIMLI KAPI-PENCERE SİSTEMİ
THERMAL WINDOW&DOOR SYSTEM

ASISTAL

11-004

0,181 kg/mt

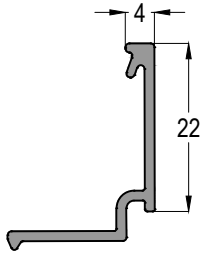

11-006

0,218 kg/mt

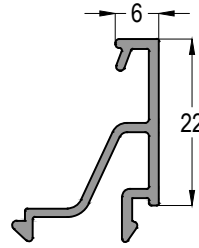

11-010

0,233 kg/mt

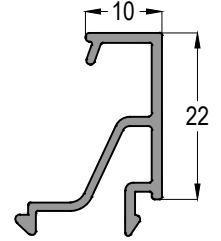

11-015

0,242 kg/mt

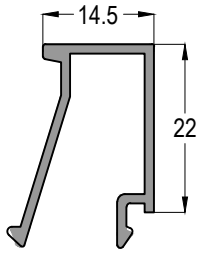

11-017

0,250 kg/mt

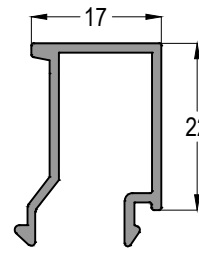

11-020

0,276 kg/mt

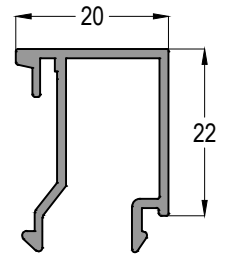

11-022

0,282 kg/mt

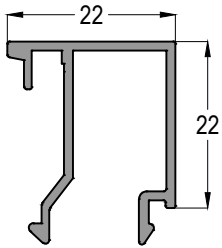

11-026

0,296 kg/mt

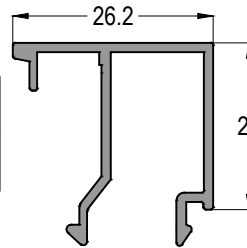

11-028

0,302 kg/mt

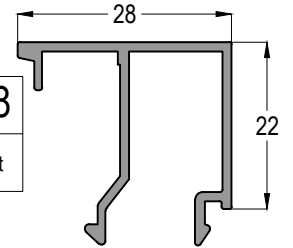

11-030

0,308 kg/mt

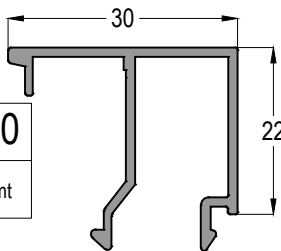

11-032

0,315 kg/mt

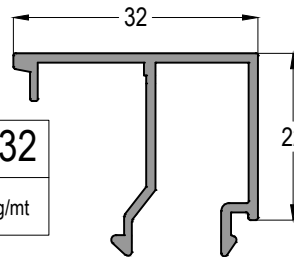

11-035

0,323 kg/mt

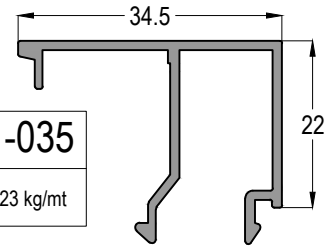

11-038

0,334 kg/mt

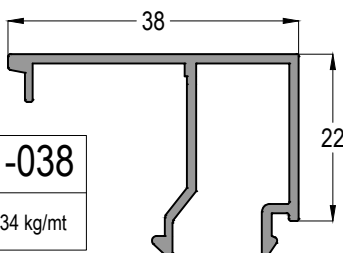

11-040

0,325 kg/mt

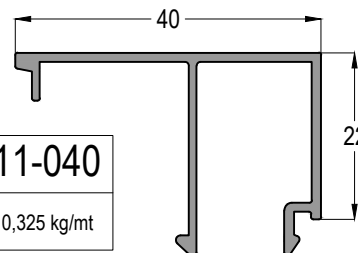

11-044

0,338 kg/mt

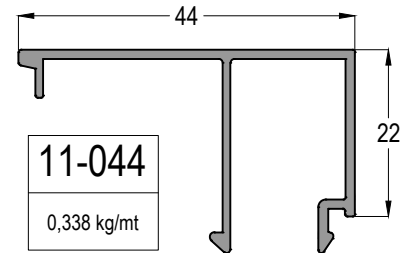

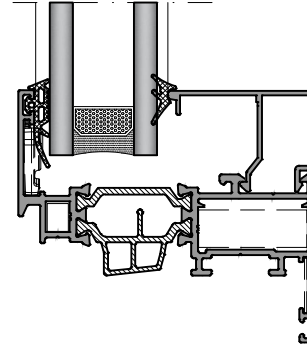
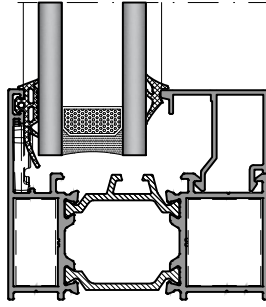

CAM KALINLIĞINA GÖRE CAM ÇİTASI SEÇİM TABLOSU
KASA-ORTA KAYIT PROFİLİ İÇİN
Glazing Bead Selection Table according to the Glass Thickness
FRAME-TRANSOM/MULLION profiles.



CAM KALINLIĞI Glass Thickness (mm)	CAM ÇİTASI Glazing Bead	İÇ CAM FİTİLİ Glass Gasket (IN)	DIŞ CAM FİTİLİ Glass Gasket (OUT) - 4 mm
20	11-035	EP2-03	EPW1-01
21	11-035	EP2-02	EPW1-01
22	11-035	EP2-01	EPW1-01
24	11-032	EP2-02	EPW1-01
25	11-030	EP2-03	EPW1-01
26	11-030	EP2-02	EPW1-01
27	11-028	EP2-03	EPW1-01
28	11-028	EP2-02	EPW1-01
29	11-026	EP2-03	EPW1-01
30	11-026	EP2-02	EPW1-01
31	11-026	EP2-01	EPW1-01
32	11-022	EP2-03	EPW1-01
33	11-022	EP2-02	EPW1-01
34	11-022	EP2-01	EPW1-01
35	11-020	EP2-03	EPW1-01
36	11-020	EP2-02	EPW1-01
37	11-020	EP2-01	EPW1-01
38	11-017	EP2-03	EPW1-01
39	11-017	EP2-02	EPW1-01
40	11-015	EP2-03	EPW1-01
42	11-015	EP2-01	EPW1-01
44	11-010	EP2-03	EPW1-01
46	11-010	EP2-02	EPW1-01
48	11-006	EP2-03	EPW1-01
50	11-006	EP2-02	EPW1-01
51	11-004	EP2-03	EPW1-01
53	11-004	EP2-01	EPW1-01

CAM KALINLIĞINA GÖRE CAM ÇİTASI SEÇİM TABLOSU
KANAT-KANAT İÇİ ORTAKAYIT-ETEK PROFİLİ
Glazing Bead Selection Table according to the Glass Thickness
SASH-SASH MULLION-BOTTOM RAIL PRO.



CAM KALINLIĞI Glass Thickness (mm)	CAM ÇİTASI Glazing Bead	İÇ CAM FİTİLİ Glass Gasket (IN)	DIŞ CAM FİTİLİ Glass Gasket (OUT) - 4 mm
20	11-044	EP2-03	EPW1-01
21	11-044	EP2-02	EPW1-01
22	11-044	EP2-01	EPW1-01
24	11-040	EP2-03	EPW1-01
25	11-040	EP2-02	EPW1-01
26	11-038	EP2-03	EPW1-01
27	11-038	EP2-02	EPW1-01
28	11-038	EP2-01	EPW1-01
29	11-035	EP2-03	EPW1-01
30	11-035	EP2-02	EPW1-01
31	11-035	EP2-01	EPW1-01
32	11-032	EP2-03	EPW1-01
33	11-032	EP2-02	EPW1-01
34	11-030	EP2-03	EPW1-01
35	11-030	EP2-02	EPW1-01
36	11-028	EP2-03	EPW1-01
37	11-028	EP2-02	EPW1-01
38	11-026	EP2-03	EPW1-01
39	11-026	EP2-02	EPW1-01
40	11-026	EP2-01	EPW1-01
42	11-022	EP2-03	EPW1-01
44	11-020	EP2-03	EPW1-01
46	11-020	EP2-01	EPW1-01
48	11-017	EP2-02	EPW1-01
50	11-015	EP2-02	EPW1-01
51	11-015	EP2-01	EPW1-01
53	11-010	EP2-03	EPW1-01

WT 68

YALITIMLI KAPI-PENCERE SİSTEMİ
THERMAL WINDOW&DOOR SYSTEM

ASISTAL

SİSTEM DETAYLARI
SYSTEM DETAILS

PENCERE AÇILIM DETAYLARI

WINDOW OPENING DETAILS

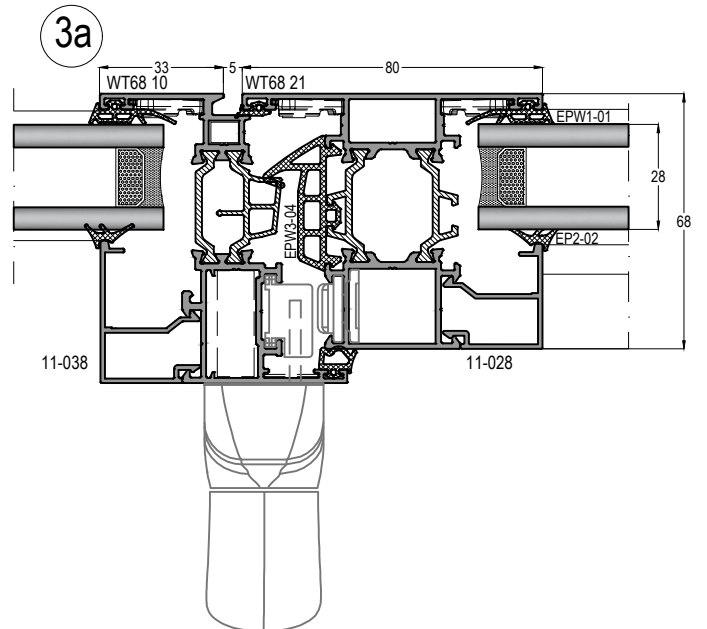
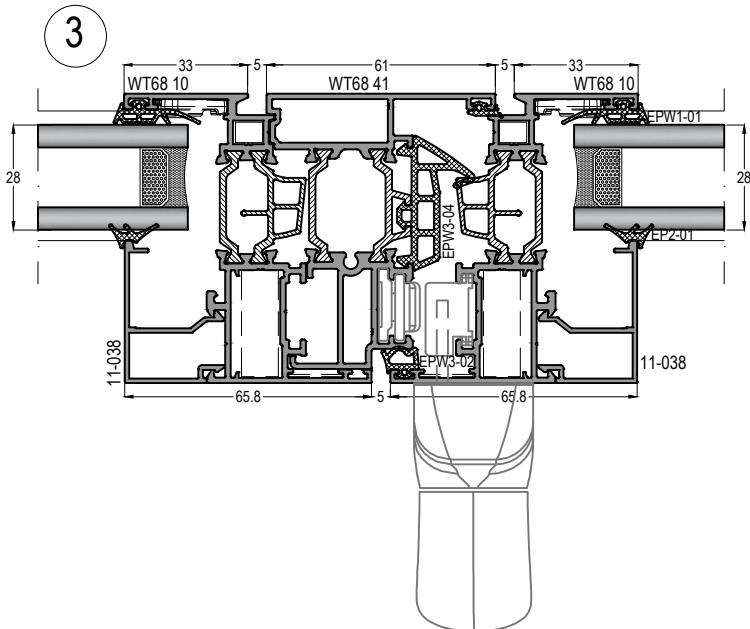
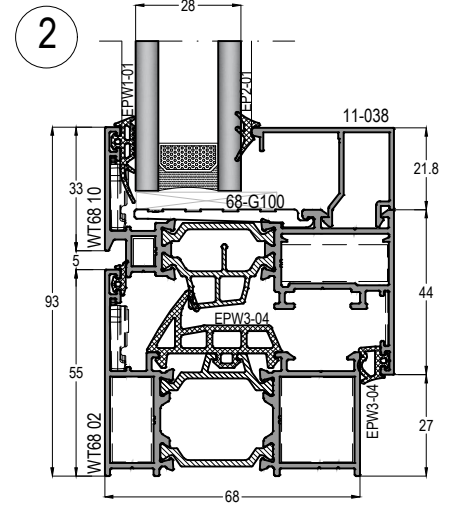
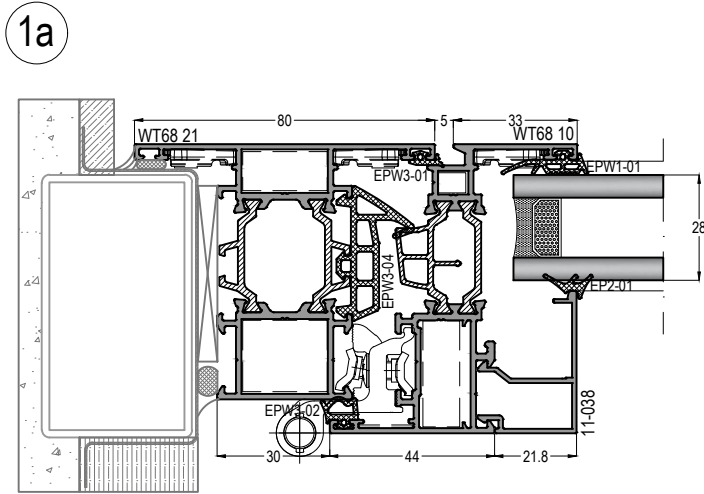
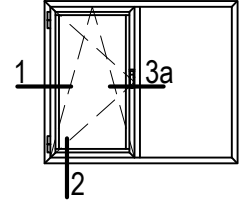
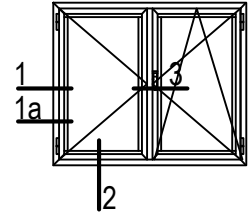
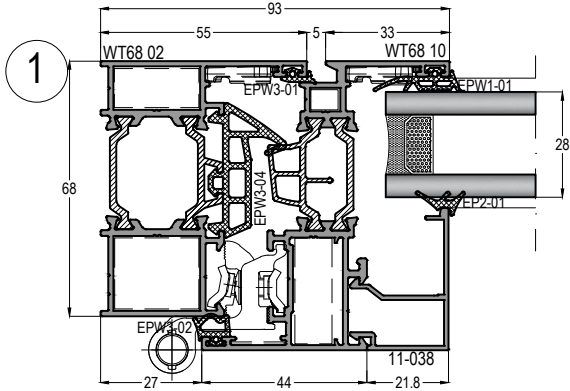

DIŞA AÇILIR KAPI DETAYLARI OUTER OPENING DOOR DETAILS

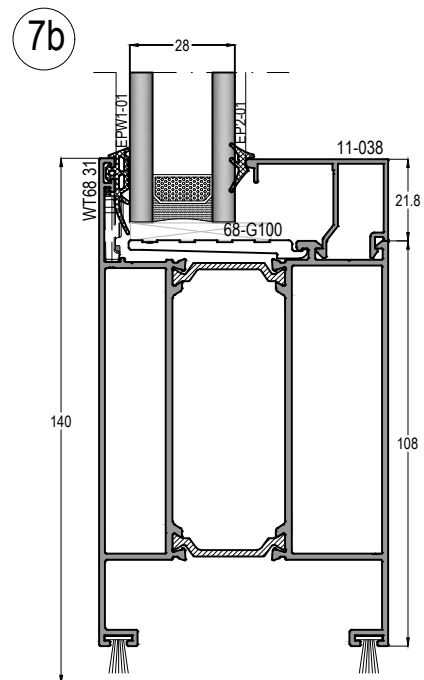
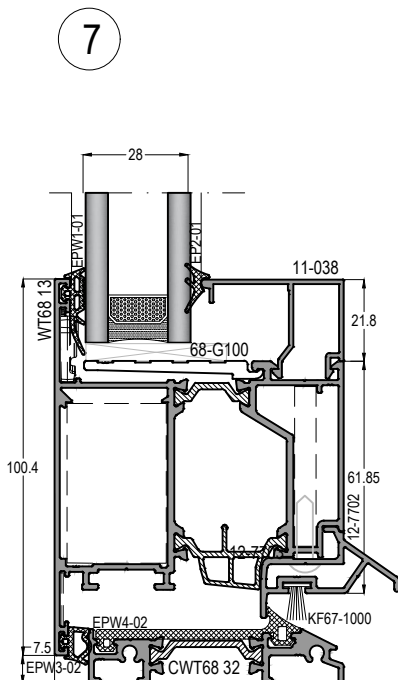
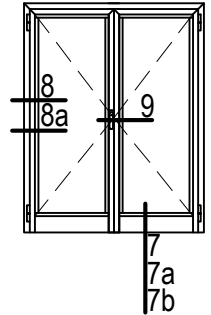
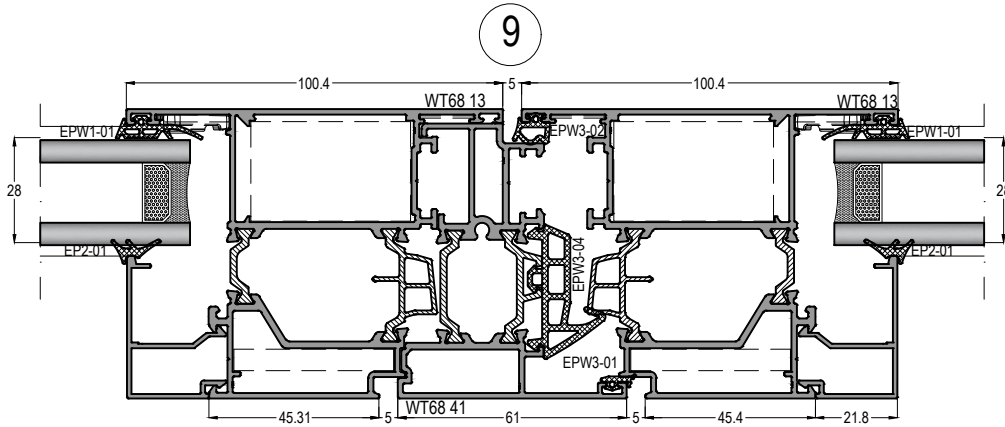
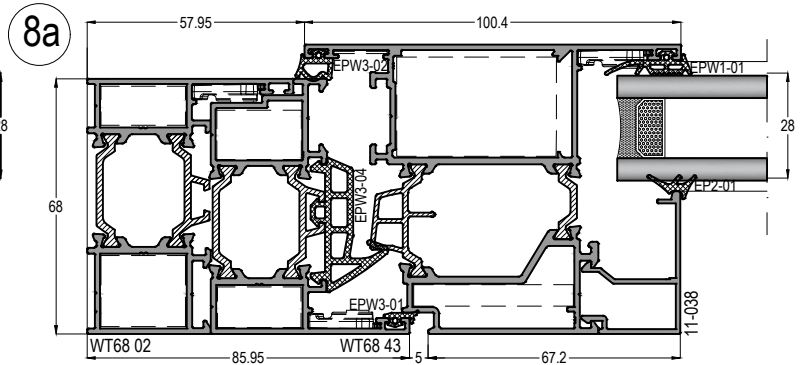
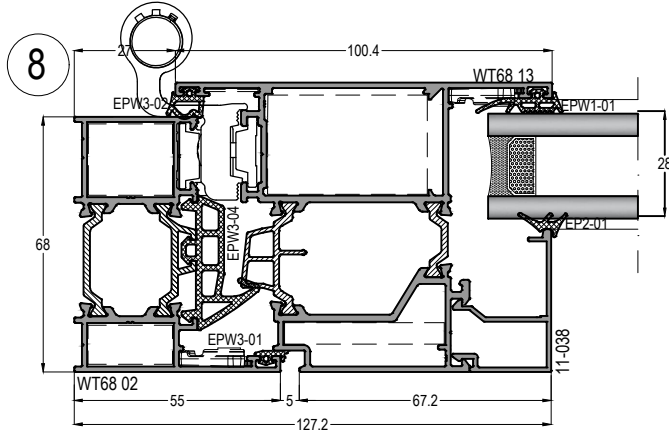



PENCERE AÇILIM DETAYLARI - PVC KANAL WINDOW OPENING DETAILS-PVC GROOVE

10

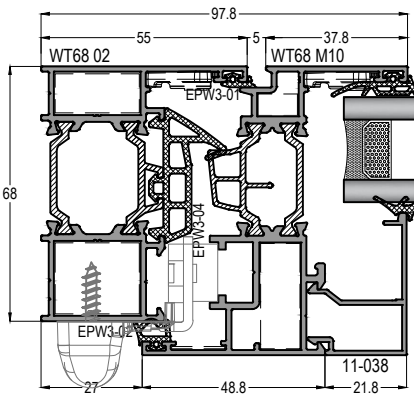

11

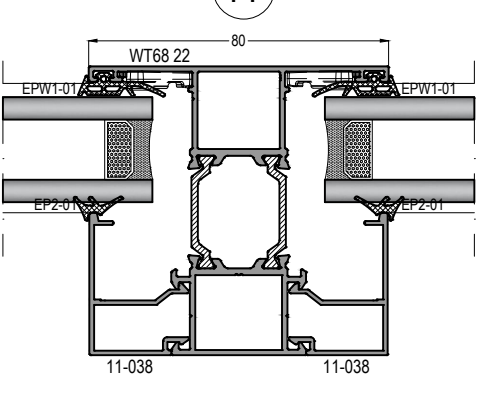

12

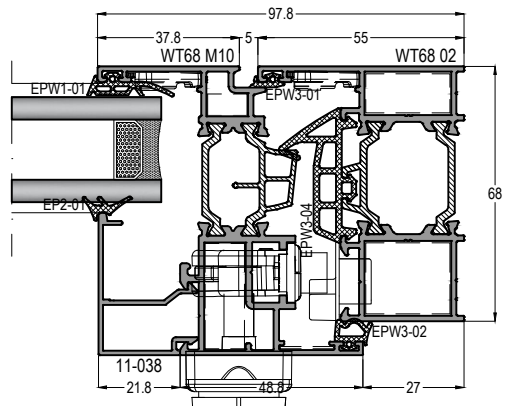

12

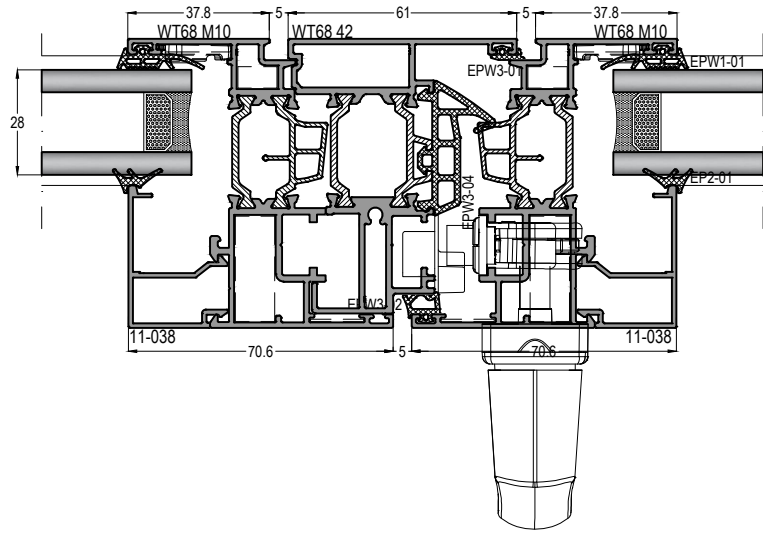

12a

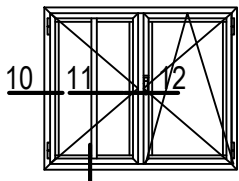
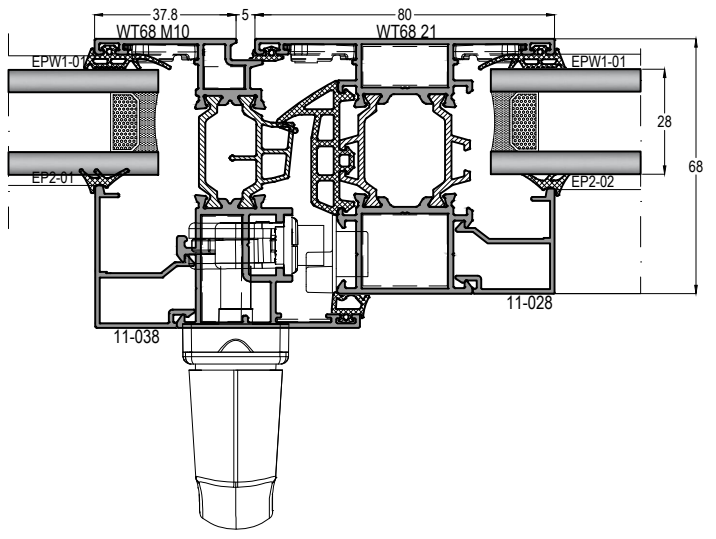

13

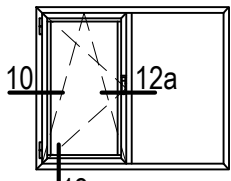

13

13

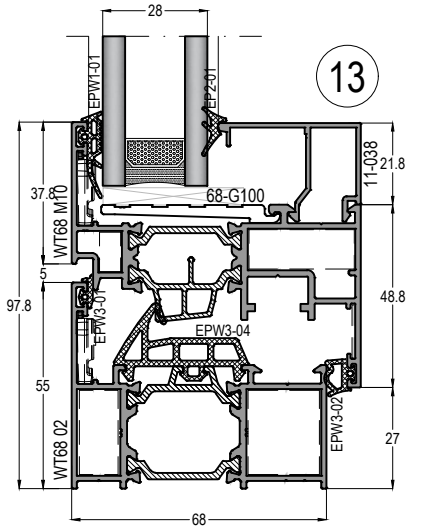

İÇE AÇILIR KAPI DETAYLARI - PVC KANAL

INNER OPENING DOOR DETAILS-PVC GROOVE

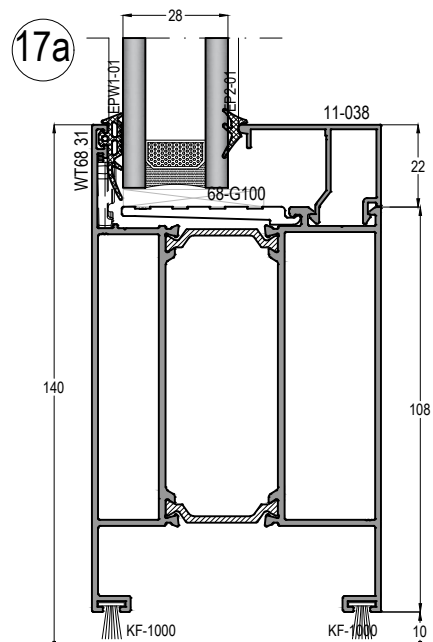
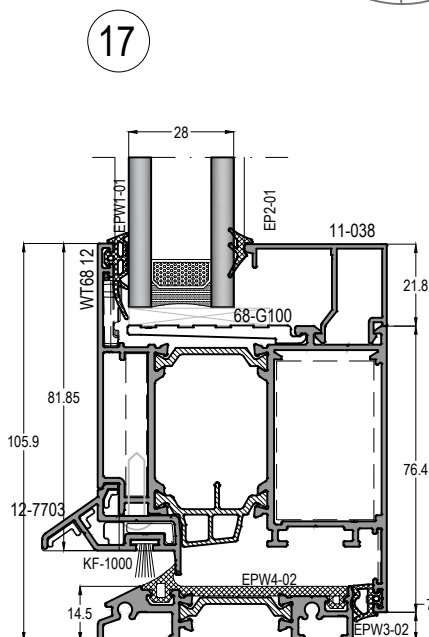
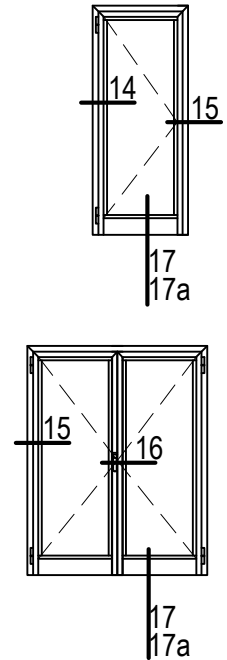
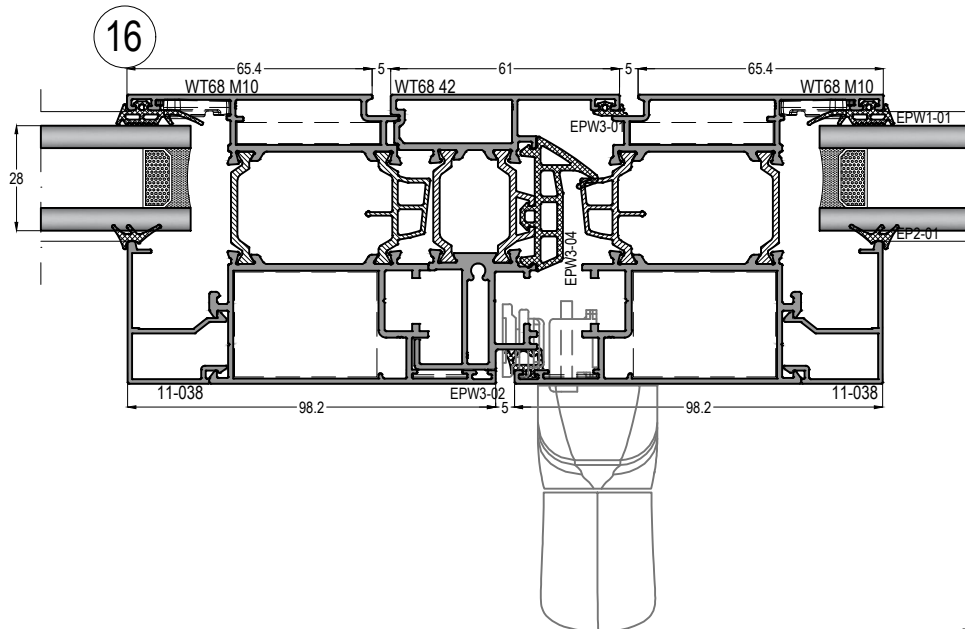
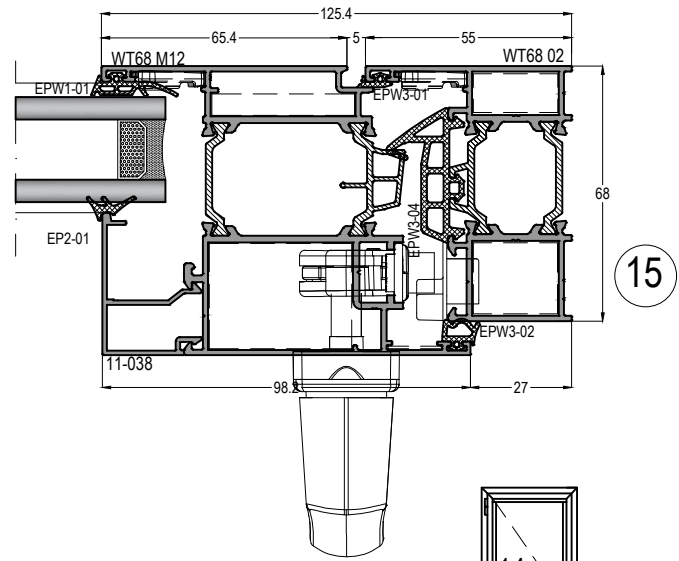
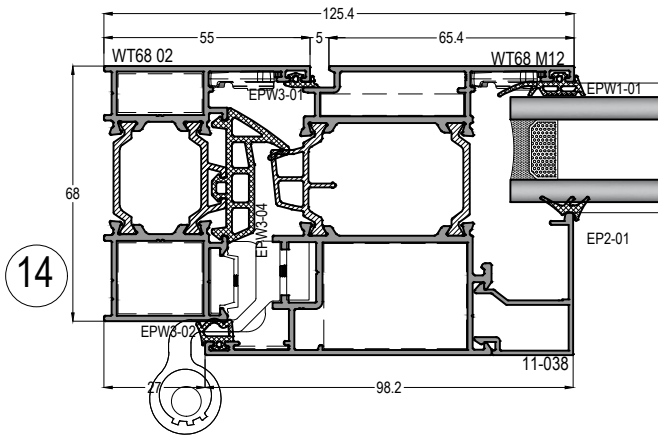

DIŞA AÇILIR PENCERE DETAYI OUTER OPENING WINDOW DETAILS

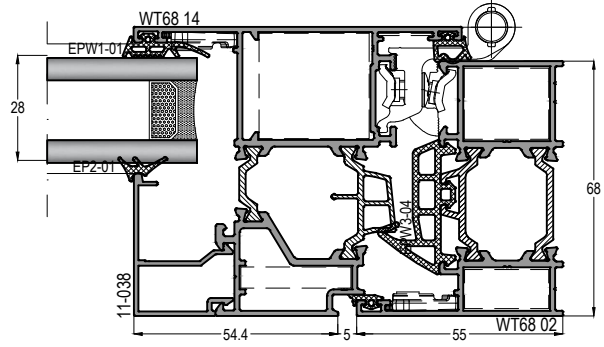
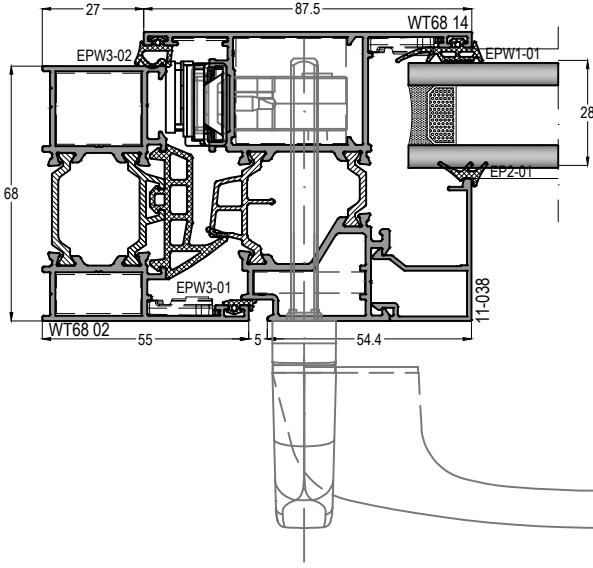

DIŞA AÇILIM PENCERE OUTSIDE HUNG

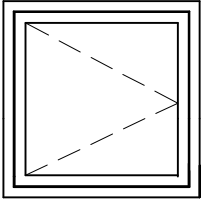

DIŞA VASİSTAS OUT TOP HUNG

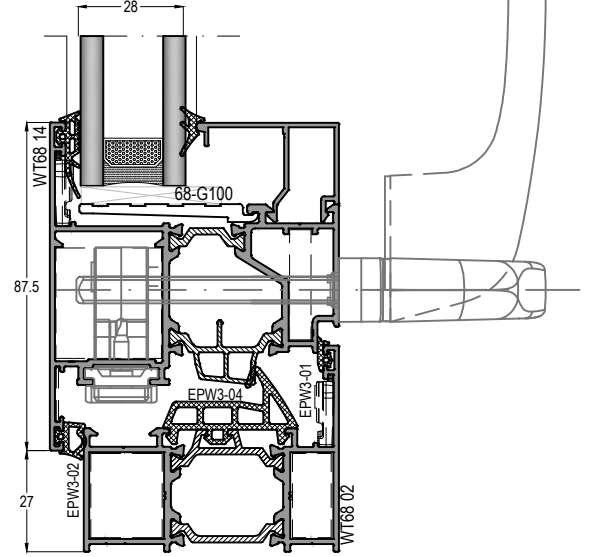
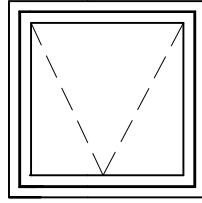

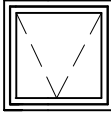
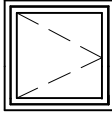
			DIŞA AÇILIM VASİSTAS MAKAS SEÇİMİ <i>Top-Hung Arm Selections</i>					DIŞA AÇILIM PENCERE MAKAS SEÇİMİ <i>Side-Hung Arm Selections</i>			
AÇIKLAMA Description	KOD Item Code	Max. Açılır Açısı Max. Opening Angle	Max. Yükseklik Max. Height (mm)	Max. Genişlik Max. Width (mm)	Max. Ağırlık Max. Weight (Kg)	Makas Yüksekliği Arm Length (mm)	Max. Açılır Açısı Max. Opening Angle	Max. Yükseklik Max. Height (mm)	Max. Genişlik Max. Width (mm)	Max. Ağırlık Max. Weight (Kg)	
DIŞA AÇILIM MAKAS-10" Eurogrove Arm	ASI-OA 001	50°	650	1500	50	259	50° 84° *	1500	650	35	
DIŞA AÇILIM MAKAS-16" Eurogrove Arm	ASI-OA 002	30° 50°	800	1500	100 55	412	30° - 50° 90° *	1600	700	60 42	
DIŞA AÇILIM MAKAS-22" Eurogrove Arm	ASI-OA 003	20° 45°	1500	1700	100 80	567	-	-	-	-	
DIŞA AÇILIM MAKAS-28" Eurogrove Arm	ASI-OA 004	15°	2000	1700	100	711	-	-	-	-	

WT68

YALITIMLI KAPI-PENCERE SİSTEMİ
THERMAL WINDOW&DOOR SYSTEM

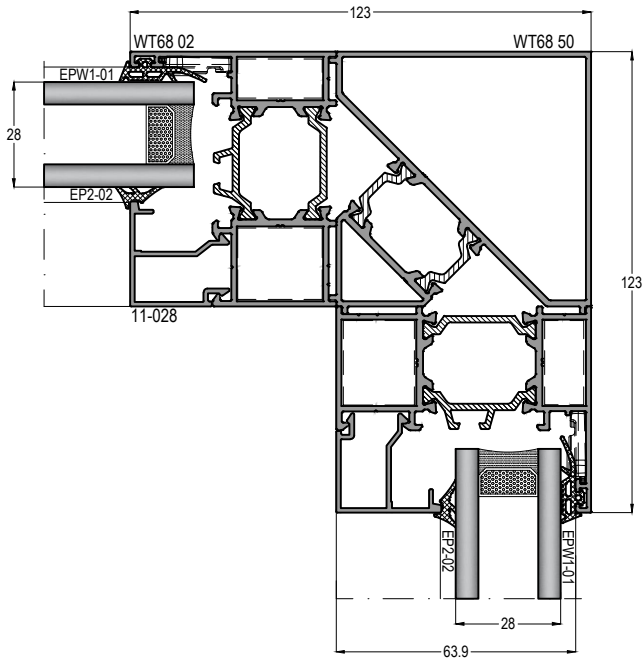

18

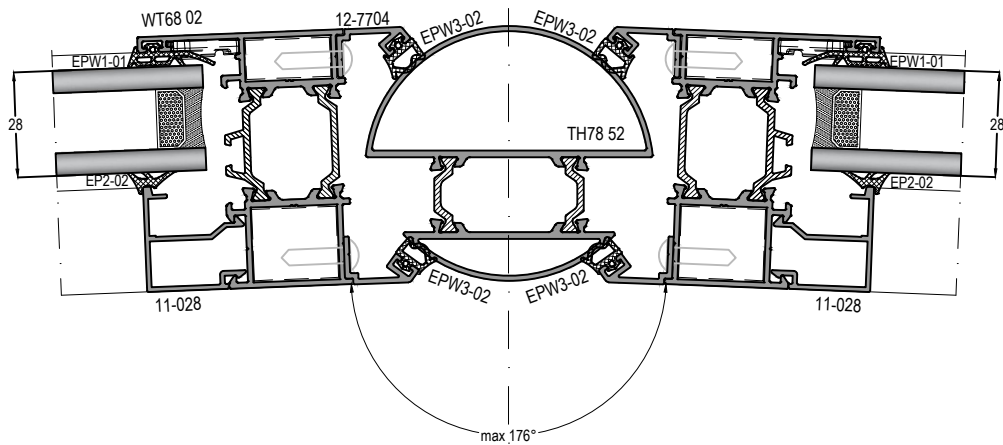
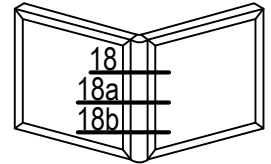

18a

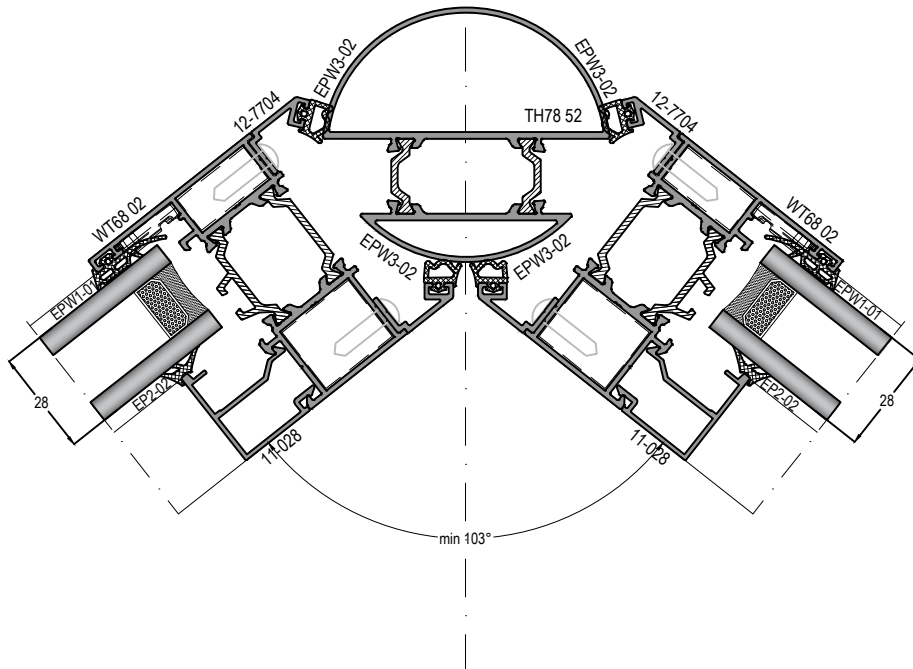

18b