







INTERNO KAPI

İÇ MEKAN KAPI SİSTEMİ
INDOOR DOOR SYSTEM

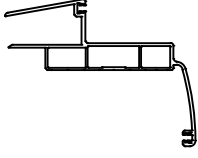
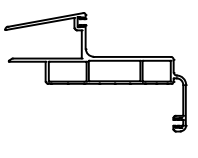

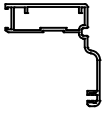
PROFİL VE AKSESUAR LİSTELERİ
PROFILE & ACCESSORIES LISTS

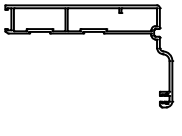
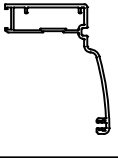
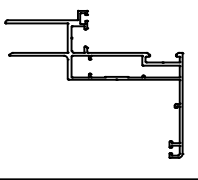
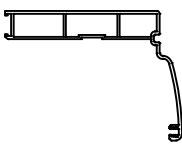
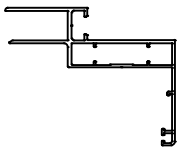
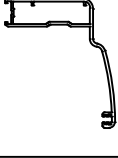

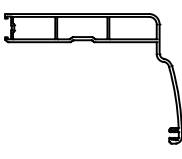
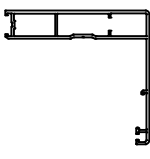
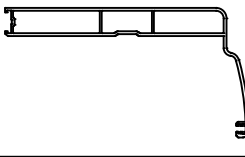
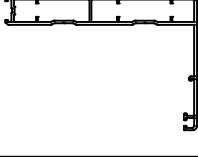
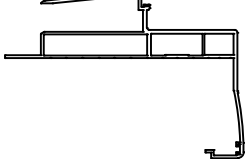
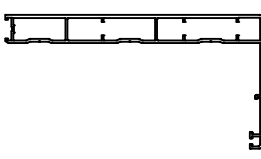
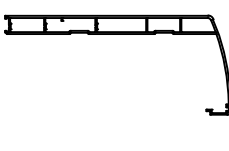
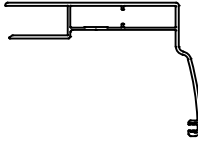







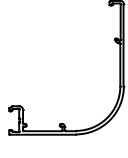
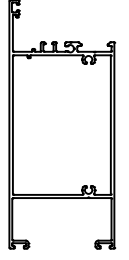
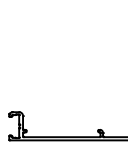
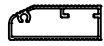
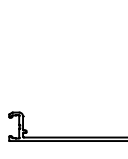
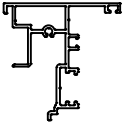

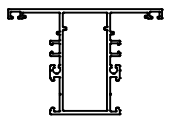

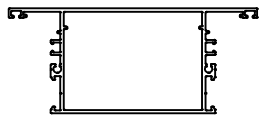
PROFİL LİSTESİ - PROFILES LIST

BR24-11			BR24-14		
KASA PROFİLİ <i>FRAME PROFILE</i>	AĞIRLIK / Weight 1,330 kg/mt		KASA PROFİLİ <i>FRAME PROFILE</i>	AĞIRLIK / Weight 1,331 kg/mt	
BR24-41			BR24-15		
ADAPTÖR PROFİLİ-35mm <i>ADAPTER PROFILE-35mm</i>	AĞIRLIK / Weight 0,371 kg/mt		KASA PROFİLİ-43mm <i>FRAME PROFILE-43mm</i>	AĞIRLIK / Weight 0,681 kg/mt	
BR24-42			BR24-16		
ADAPTÖR PROFİLİ-70mm <i>ADAPTER PROFILE-70mm</i>	AĞIRLIK / Weight 0,551 kg/mt		KASA PROFİLİ-81mm <i>FRAME PROFILE-81mm</i>	AĞIRLIK / Weight 1,003 kg/mt	
BR24-12			BR23-11		
KASA PROFİLİ-43mm <i>FRAME PROFILE-43mm</i>	AĞIRLIK / Weight 0,770 kg/mt		KASA PROFİLİ <i>FRAME PROFILE</i>	AĞIRLIK / Weight 1,326 kg/mt	
BR24-13			BR23-12		
KASA PROFİLİ-81mm <i>FRAME PROFILE-81mm</i>	AĞIRLIK / Weight 1,117 kg/mt		KASA PROFİLİ <i>FRAME PROFILE</i>	AĞIRLIK / Weight 1,239 kg/mt	
BR24-51			BR23-21		
KASA PROFİLİ-46mm <i>FRAME PROFILE-46mm</i>	AĞIRLIK / Weight 0,762 kg/mt		KASA PROFİLİ-50mm <i>FRAME PROFILE-50mm</i>	AĞIRLIK / Weight 0,794 kg/mt	
BR26-43			BR23-22		
KASA PROFİLİ-81mm <i>FRAME PROFILE-81mm</i>	AĞIRLIK / Weight 1,122 kg/mt		KASA PROFİLİ-75mm <i>FRAME PROFILE-75mm</i>	AĞIRLIK / Weight 1,030 kg/mt	
BR26-42			BR23-23		
KASA PROFİLİ-116mm <i>FRAME PROFILE-116mm</i>	AĞIRLIK / Weight 1,396 kg/mt		KASA PROFİLİ-100mm <i>FRAME PROFILE-100mm</i>	AĞIRLIK / Weight 1,260 kg/mt	
BR24-18			BR23-24		
KASA PROFİLİ <i>FRAME PROFILE</i>	AĞIRLIK / Weight 1,916 kg/mt		KASA PROFİLİ-135mm <i>FRAME PROFILE-135mm</i>	AĞIRLIK / Weight 1,558 kg/mt	
BR24-17			BR24-19		
KASA PROFİLİ-170mm <i>FRAME PROFILE-170mm</i>	AĞIRLIK / Weight 2,151 kg/mt		AYARLI PERVAZ PROFİLİ <i>FRAME PROFILE</i>	AĞIRLIK / Weight 1,150 kg/mt	





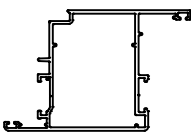





Profil ağırlıklarımız teorik olup; teslim anındaki tartımız geçerlidir.

Profile weights are theoretical and the weight at the time of delivery is valid.

PROFİL LİSTESİ - PROFILES LIST













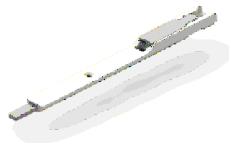

BR24-32			C55 31	Jx cm ⁴	Jy cm ⁴	
AYARLI PERVAZ PROFİLİ FRAME PROFILE			AĞIRLIK / Weight	104,06	36,64	
		0,708 kg/mt	ETEK PROFİLİ-130 mm BOTTOM PLATE PROFILE		1,941 kg/mt	
BR24-33			12-33			
AYARLI PERVAZ PROFİLİ FRAME PROFILE			AĞIRLIK / Weight	EŞİK PROFİLİ BOTTOM RAIL PROFILE		AĞIRLIK / Weight
		0,830 kg/mt			0,412 kg/mt	
BR24-34			C55 41			
AYARLI PERVAZ PROFİLİ FRAME PROFILE			AĞIRLIK / Weight	ÇİFT KANAT ADAPTÖR PROFİLİ DOUBLE SASH ADAPTER PROFILE		AĞIRLIK / Weight
		0,949 kg/mt			1,037 kg/mt	
BR24-22			C55 22	Jx cm ⁴	Jy cm ⁴	
KAPI KANAT PROFİLİ DOOR SASH PROFILE			AĞIRLIK / Weight	19,44	15,87	
		0,518 kg/mt	ORTA KAYIT PROFİLİ 80 mm TRANSOM-MULLION PROFILE		1,337 kg/mt	
BR24-28			C55 23	Jx cm ⁴	Jy cm ⁴	
KAPI KANAT PROFİLİ DOOR SASH PROFILE Glass 5mm			AĞIRLIK / Weight	32,36	88,07	
		0,540 kg/mt	ORTA KAYIT PROFİLİ 130 mm TRANSOM-MULLION PROFILE		1,817 kg/mt	
BR24-23			11-004			
KAPI KANAT PROFİLİ DOOR SASH PROFILE			AĞIRLIK / Weight	CAM ÇİTASI-4mm GLAZING BEAD PROFILE		AĞIRLIK / Weight
		0,391 kg/mt			0,181 kg/mt	
BR24-21			11-006			
CAM KAPI KANAT PROFİLİ DOOR SASH PROFILE			AĞIRLIK / Weight	CAM ÇİTASI-6mm GLAZING BEAD PROFILE		AĞIRLIK / Weight
		0,788 kg/mt			0,217 kg/mt	
BR24-24			11-010			
CAM KAPI KANAT PROFİLİ DOOR SASH PROFILE			AĞIRLIK / Weight	CAM ÇİTASI-10mm GLAZING BEAD PROFILE		AĞIRLIK / Weight
		0,729 kg/mt			0,233 kg/mt	
BR24-31			11-015			
ADAPTÖR PROFİLİ ADAPTER PROFILE			AĞIRLIK / Weight	CAM ÇİTASI-15mm GLAZING BEAD PROFILE		AĞIRLIK / Weight
		0,331 kg/mt			0,244 kg/mt	
C55 13			11-017			
İÇE AÇILIR KAPI KANAT PROFİLİ-64mm INNER OPENING DOOR SASH PROFILE			Jx cm ⁴	Jy cm ⁴		AĞIRLIK / Weight
		32,85	33,22	0,249 kg/mt		
		AĞIRLIK / Weight	CAM ÇİTASI-17mm GLAZING BEAD PROFILE		AĞIRLIK / Weight	
		1,472 kg/mt			0,249 kg/mt	

PROFİL LİSTESİ - PROFILES LIST

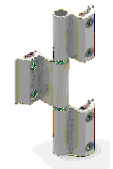

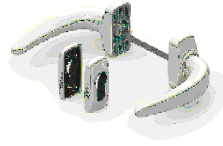
11-020				
CAM ÇİTASI-20mm <i>GLAZING BEAD PROFILE</i>	AĞIRLIK / Weight 0,276 kg/mt			
11-022				
CAM ÇİTASI-22mm <i>GLAZING BEAD PROFILE</i>	AĞIRLIK / Weight 0,282 kg/mt			
11-026				
CAM ÇİTASI-26mm <i>GLAZING BEAD PROFILE</i>	AĞIRLIK / Weight 0,296 kg/mt			
11-028				
CAM ÇİTASI-28mm <i>GLAZING BEAD PROFILE</i>	AĞIRLIK / Weight 0,301 kg/mt			
11-030				
CAM ÇİTASI-30mm <i>GLAZING BEAD PROFILE</i>	AĞIRLIK / Weight 0,309 kg/mt			
11-032				
CAM ÇİTASI-32mm <i>GLAZING BEAD PROFILE</i>	AĞIRLIK / Weight 0,313 kg/mt			
11-035				
CAM ÇİTASI-35mm <i>GLAZING BEAD PROFILE</i>	AĞIRLIK / Weight 0,322 kg/mt			
11-038				
CAM ÇİTASI-38mm <i>GLAZING BEAD PROFILE</i>	AĞIRLIK / Weight 0,333 kg/mt			
12-01				
DAMLALIK PROFİLİ <i>RAINDROP PROFILE</i>	AĞIRLIK / Weight 0,198 kg/mt			
03-040040-20R				
L PROFİLİ <i>L PROFILE</i>	AĞIRLIK / Weight 0,421 kg/mt			

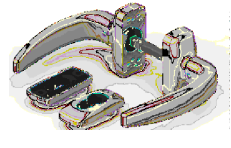
Profil ağırlıklarımız teorik olup; teslim anındaki tartımız geçerlidir.

Profile weights are theoretical and the weight at the time of delivery is valid.

EP1-01			MO-60		
DIŞ CAM FİTİLİ - 3,5 mm <i>OUTER GLAZING GASKET</i>	KOLİ MİKTARI/Package 240 mt / 15 kg		KENET BİNI FİTİLİ <i>CENTRAL SEALING GASKET</i>	KOLİ MİKTARI/Package 200 mt	
EP2-01			EP3-03		
İÇ CAM FİTİLİ - 3 mm <i>INNER GLAZING GASKET</i>	KOLİ MİKTARI/Package 440 mt / 15 kg		KANAT BİNI FİTİLİ <i>SASH GASKET</i>	KOLİ MİKTARI/Package 430 mt / 15 kg	
EP2-02			KF 67-1000		
İÇ CAM FİTİLİ - 4 mm <i>INNER GLAZING GASKET</i>	KOLİ MİKTARI/Package 300 mt / 15 kg		FİRÇA FİTİL - 10mm <i>BRUSH GASKET</i>	KOLİ MİKTARI/Package 600 mt	
EP2-03			ASI-F 100A		
İÇ CAM FİTİLİ - 5 mm <i>INNER GLAZING GASKET</i>	KOLİ MİKTARI/Package 250 mt / 15 kg		KAPI ALTI FİRÇASI <i>DOOR BRUSH GASKET</i>	KOLİ MİKTARI/Package Adet / Piece	
EP3-01			ASI-B 2215		
KANAT BİNI FİTİLİ <i>SASH GASKET</i>	KOLİ MİKTARI/Package 430 mt / 15 kg		SÜRGÜ KİLİTLEME-UZUN <i>SASH FIXING LOCK-LONG</i>	KOLİ MİKTARI/Package 120 Adet / Piece	
EP3-02			ASI-H 9733		
KASA BİNI FİTİLİ <i>FRAME GASKET</i>	KOLİ MİKTARI/Package 750 mt / 15 kg		SİSTEM ÜÇLÜ MENTEŞE <i>TRIPLE SYSTEM HINGE</i>	KOLİ MİKTARI/Package 250 Adet / Piece	
INT-004			ASI-H 3300		
KAPI KANAT CAM FİTİLİ 8mm CAM İÇİN <i>DOOR SASH GLASS GASKET</i>	KOLİ MİKTARI/Package 6 mt / kg		SİSTEM KAPI MENTEŞESİ <i>SYSTEM DOOR HINGE</i>	KOLİ MİKTARI/Package Adet / Piece	
INT-005			ASI-DH 2051		
KAPI KANAT CAM FİTİLİ 10mm CAM İÇİN <i>DOOR SASH GLASS GASKET</i>	KOLİ MİKTARI/Package 6 mt / kg		KAPI KOLU <i>DOOR HANDLE</i>	KOLİ MİKTARI/Package Adet / Piece	
INT2-01			ASI-DH 2070		
KASA BİNI FİTİLİ <i>FRAME GASKET</i>	KOLİ MİKTARI/Package mt / kg		KAPI KOLU <i>DOOR HANDLE</i>	KOLİ MİKTARI/Package Adet / Piece	
INT2-02			ASI-DH 60Y		
KASA KANAL FİTİLİ <i>FRAME GASKET</i>	KOLİ MİKTARI/Package mt / kg		ÇEKME KAPI KOLU <i>DOOR HANDLE</i>	KOLİ MİKTARI/Package Adet / Piece	

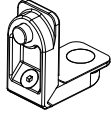
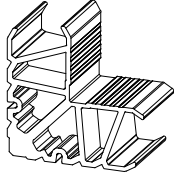
ASI-BRL 83			ASI-AK 545		
83 LİK BAREL <i>CYLINDER 83</i>	KOLİ MİKTARI/Package Adet / Piece		SÜRGÜ KİLİTLEME <i>SASH FIXING BOLT</i>	KOLİ MİKTARI/Package Adet / Piece	
ASI-153 35			C55 HOK		
DİLLİ KİLİT <i>MORTISE LOCK WITH CYLINDER</i>	KOLİ MİKTARI/Package Adet / Piece		ADAPTÖR KAPAĞI <i>ADAPTER COVER</i>	KOLİ MİKTARI/Package alt-üst 1 takım	
ASI-LS 90185D			ASI-SB 12		
DİLLİ KİLİT KARŞILIĞI <i>LOCK STRIKES</i>	KOLİ MİKTARI/Package Adet / Piece		KÖŞE GÖNYESİ <i>CORNER ALIGNMENT</i>	KOLİ MİKTARI/Package 1000 Adet	
ASI-155 35			ASI-SB 19		
MAKARALI KİLİT <i>MORTISE LOCK WITH ROLLER</i>	KOLİ MİKTARI/Package Adet / Piece		KÖŞE GÖNYESİ <i>CORNER ALIGNMENT</i>	KOLİ MİKTARI/Package 1000 Adet	
ASI-LS 90185M			ASI-SB 19.1		
MAKARALI KİLİT KARŞILIĞI <i>ROLLER LOCK STRIKES</i>	KOLİ MİKTARI/Package Adet / Piece		KÖŞE GÖNYESİ <i>CORNER ALIGNMENT</i>	KOLİ MİKTARI/Package 1000 Adet / Piece	
ASI-HCS 01			ASI-MO 21		
AHŞAP VE CAM KAPI KOLU <i>WOOD & GLASS DOOR HANDLE</i>	KOLİ MİKTARI/Package Adet / Piece		PLASTİK KÖŞE GÖNYESİ <i>CORNER ALIGNMENT</i>	KOLİ MİKTARI/Package Adet / Piece	
			ASI-FUJI 2000		
			AYARLI KÖŞE GÖNYESİ <i>CORNER ALIGNMENT</i>	KOLİ MİKTARI/Package Adet / Piece	
ASI-HCS 01A			ASI-KT 1119		
CAM KAPI KOL AYNASI <i>GLASS DOOR HANDLE ACCESSORY</i>	KOLİ MİKTARI/Package Adet / Piece		KÖŞE TAKOZU <i>CORNER JOINT</i>	KOLİ MİKTARI/Package Adet / Piece	
ASI-INT 01-S			ASI-PB 1119		
KAPI YAPRAK MENTEŞE KANAT TEK CAM <i>DOOR HINGE-SINGLE GLASS</i>	KOLİ MİKTARI/Package Adet / Piece		PİMLİ KÖŞE BAĞLANTI <i>CORNER JOINT</i>	KOLİ MİKTARI/Package Adet / Piece	
ASI-INT 01-D			ASI-KT 1126		
KAPI YAPRAK MENTEŞE KANAT ÇİFT CAM - AHŞAP <i>DOOR HINGE-DOUBLE GLASS -WOOD</i>	KOLİ MİKTARI/Package Adet / Piece		KÖŞE TAKOZU <i>CORNER JOINT</i>	KOLİ MİKTARI/Package Adet / Piece	

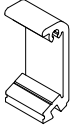
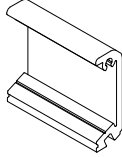
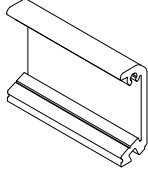
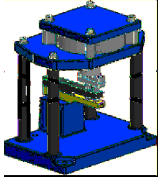
ASI-PB 1126				
PİMLİ KÖŞE BAĞLANTI <i>CORNER JOINT</i>	KOLİ MİKTARI/Package Adet / Piece			
ASI-KT 4342				
KÖŞE TAKOZU <i>CORNER JOINT</i>	KOLİ MİKTARI/Package Adet / Piece			
ASI-P 100.1				
ORTA KAYIT BAĞLANTI <i>T JOINT FIXING</i>	KOLİ MİKTARI/Package 250 Adet / Piece			
ASI-DB 9123				
DİK BAĞLANTI <i>T JOINT</i>	KOLİ MİKTARI/Package Adet / Piece			
ASI-DB 9164				
DİK BAĞLANTI <i>T JOINT</i>	KOLİ MİKTARI/Package Adet / Piece			
ASI-DB 9172				
DİK BAĞLANTI <i>T JOINT</i>	KOLİ MİKTARI/Package Adet / Piece			
501 EKO PANÇ				
KÖŞE PİMLİ BAĞLANTI PANÇ MAKİNESİ <i>PUNCH MACHINE FOR CORNER JOINT WITH PIN</i>	KOLİ MİKTARI/Package Adet / Piece			



PROFİL DETAYLARI
PROFILE DETAILS

INTERNO KAPI - DÜZ PERVAZLI SERİ

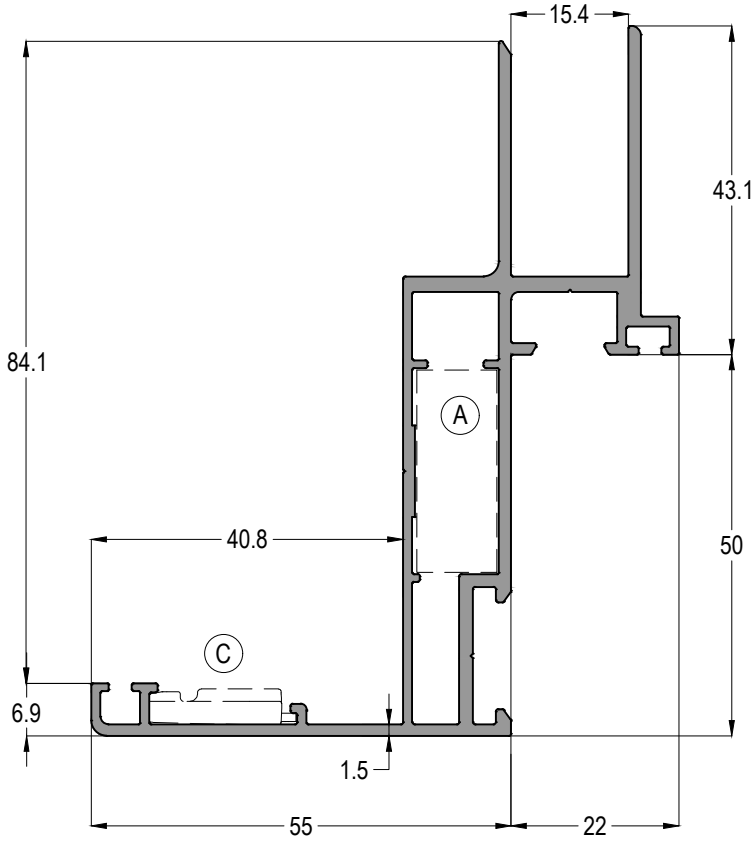
INTERNO DOOR - FLAT SERIAL



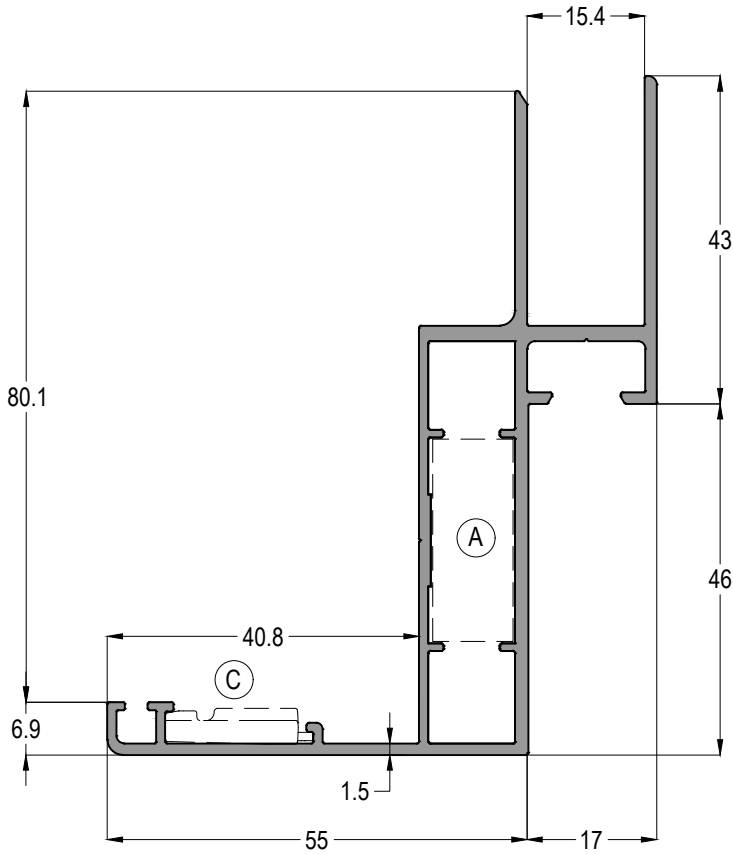

BR23-11

 (A)		 (C)	AĞIRLIK / Weight
ASI-KT 1126	- ASI-PB 1126	ASI-FUJI 2000	1,326 kg/mt



BR23-12

 (A)		 (C)	AĞIRLIK / Weight
ASI-KT 1126	- ASI-PB 1126	ASI-FUJI 2000	1,239 kg/mt

INTERNO KAPI



İÇ MEKAN KAPI SİSTEMİ
INDOOR DOOR SYSTEM

ASISTAL

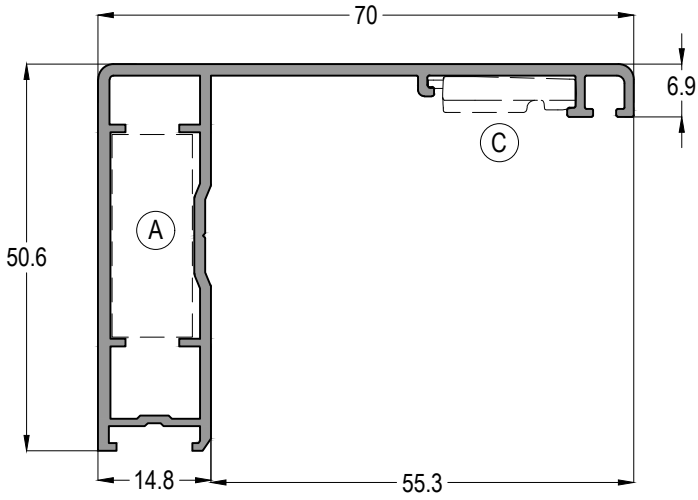
INTERNO KAPI - DÜZ PERVAZLI SERİ INTERNO DOOR - FLAT SERIAL



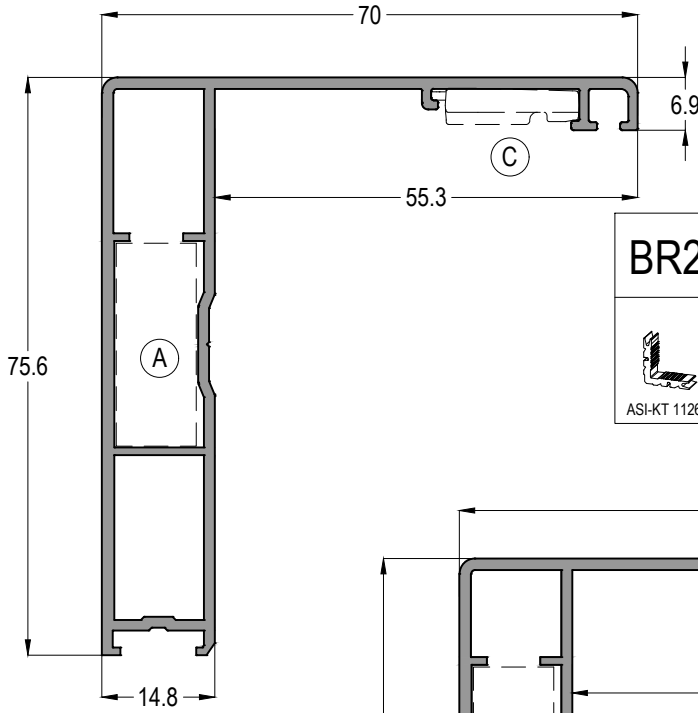

BR23-21

			AĞIRLIK / Weight
ASI-KT 1126	ASI-PB 1126	ASI-FUJI 2000	0,794 kg/mt



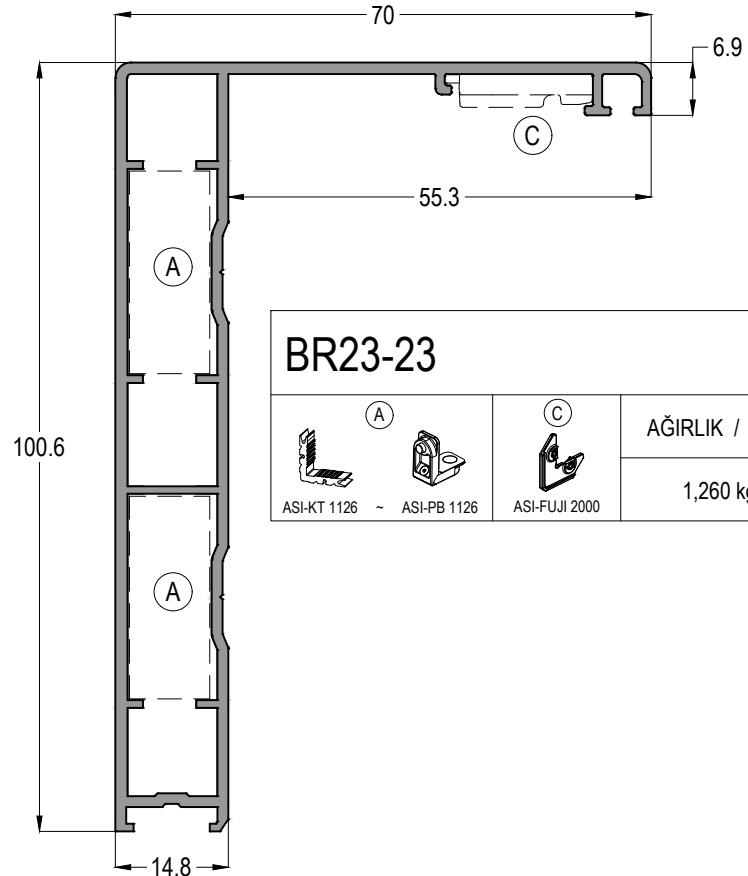

BR23-22

			AĞIRLIK / Weight
ASI-KT 1126	ASI-PB 1126	ASI-FUJI 2000	1,030 kg/mt



BR23-23

			AĞIRLIK / Weight
ASI-KT 1126	ASI-PB 1126	ASI-FUJI 2000	1,260 kg/mt

Profil ağırlıklarımız teorik olup; teslim anındaki tartımız geçerlidir.
Profile weights are theoretical and the weight at the time of delivery is valid.



INTERNO KAPI

İÇ MEKAN KAPI SİSTEMİ
INDOOR DOOR SYSTEM

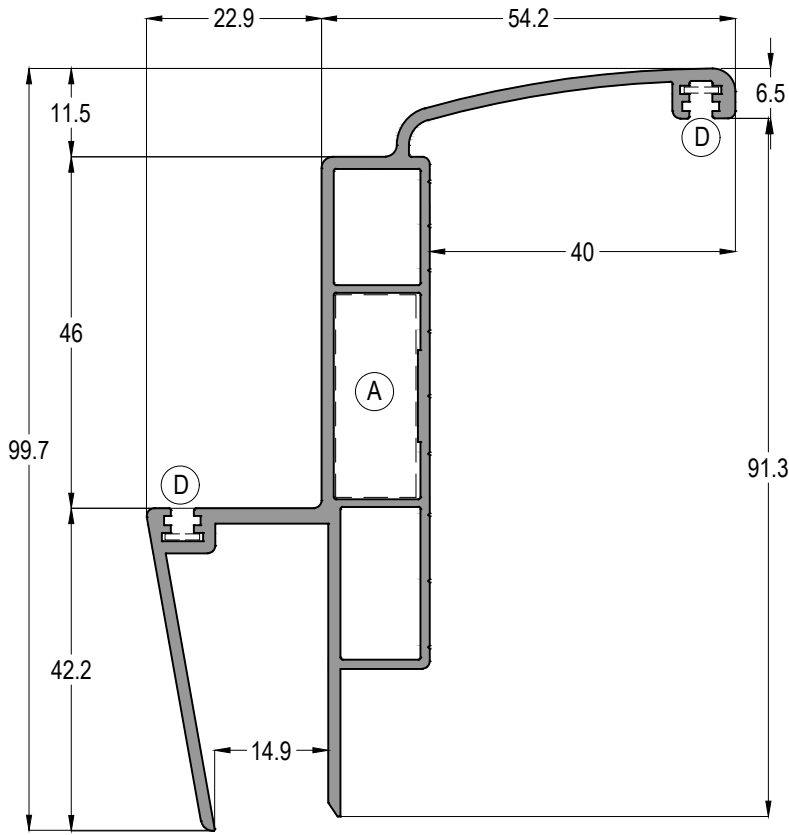
ASISTAL



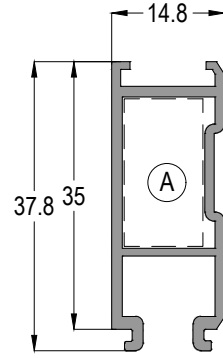

BR24-11

			AĞIRLIK / Weight
ASI-KT 1126	~ ASI-PB 1126	ASI-SB 19	1,330 kg/mt





BR24-41

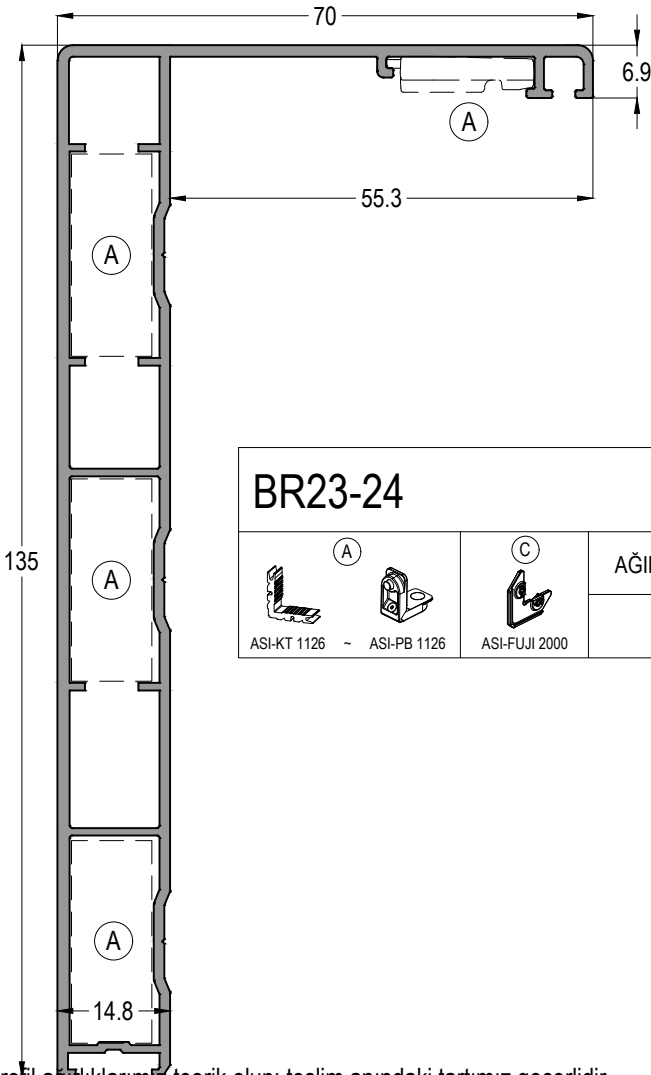
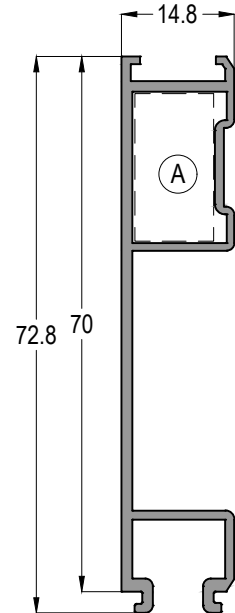

		AĞIRLIK / Weight
ASI-KT 1119	~ ASI-PB 1119	0,371 kg/mt



BR23-24

			AĞIRLIK / Weight
ASI-KT 1126	~ ASI-PB 1126	ASI-FUJI 2000	1,558 kg/mt

BR24-42

		AĞIRLIK / Weight
ASI-KT 1119	~ ASI-PB 1119	0,551 kg/mt



Profil ağırlıklarımız teorik olup; teslim anındaki tartımız geçerlidir.
Profile weights are theoretical and the weight at the time of delivery is valid.

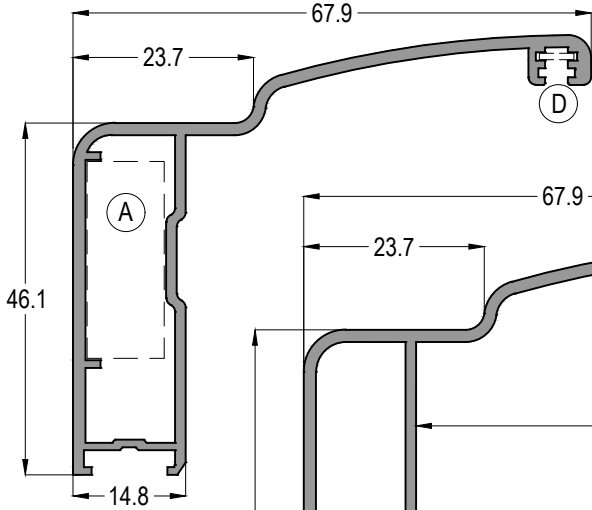

INTERNO KAPI - STANDART SERİ INTERNO DOOR - STANDART SERIAL



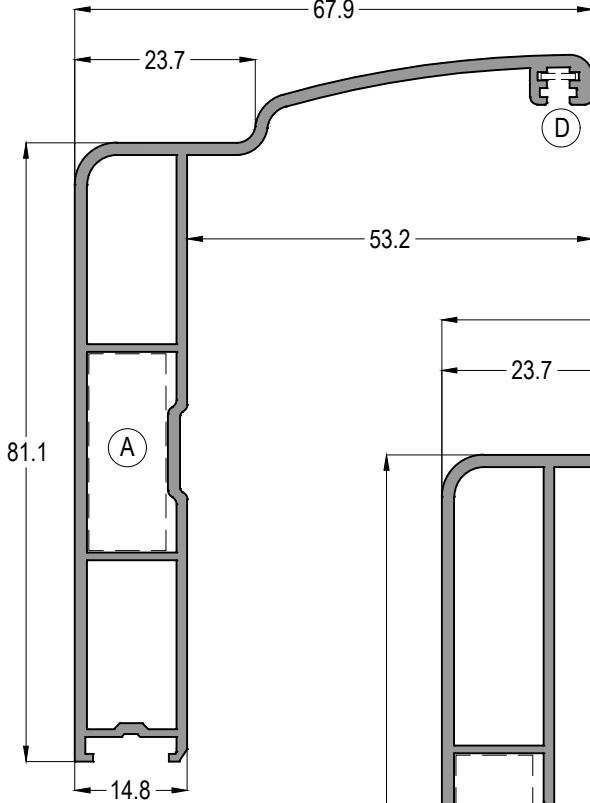

BR24-51

 ASI-PB 1126	 ASI-SB 19	AĞIRLIK / Weight 0,762 kg/mt
--	---	---------------------------------



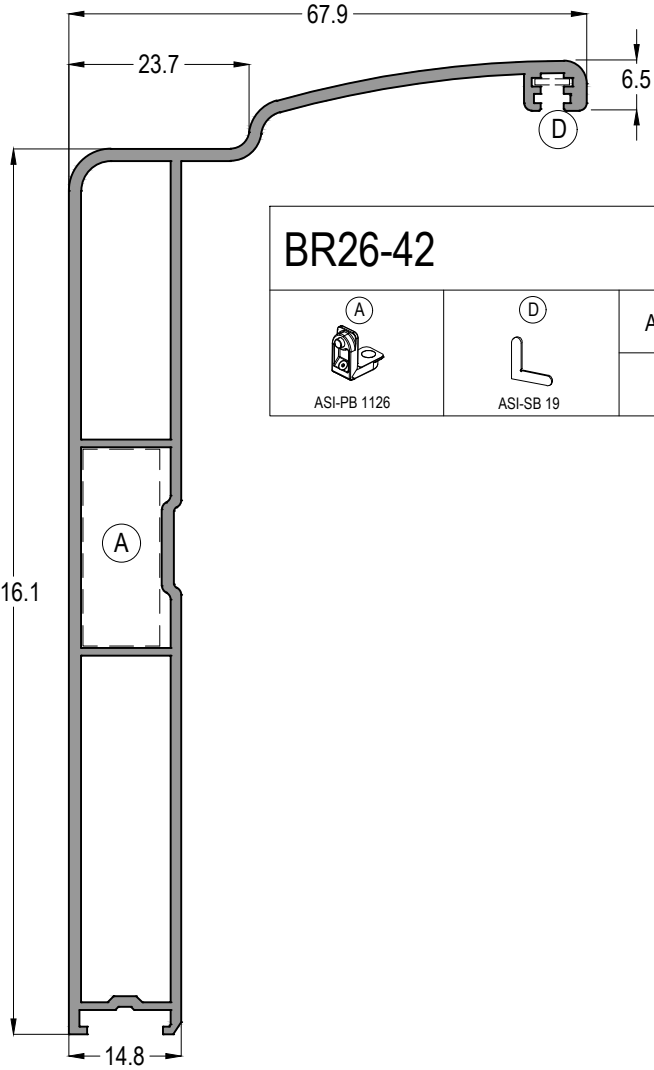

BR26-43

 ASI-PB 1126	 ASI-SB 19	AĞIRLIK / Weight 1,122 kg/mt
---	--	---------------------------------



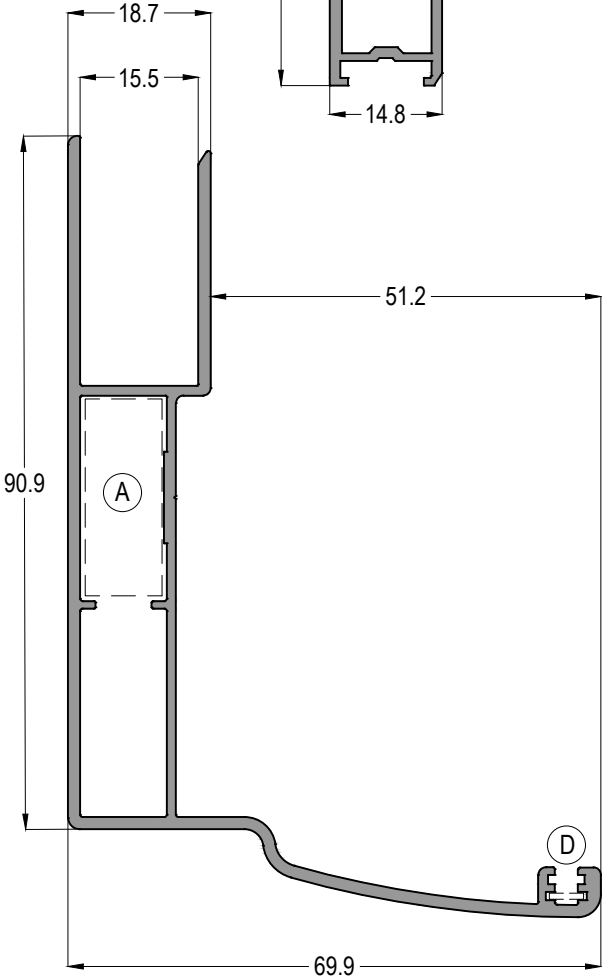

BR26-42

 ASI-PB 1126	 ASI-SB 19	AĞIRLIK / Weight 1,396 kg/mt
---	--	---------------------------------



BR24-19



 ASI-KT 1126	 ASI-PB 1126	 ASI-SB 19	AĞIRLIK / Weight 1,150 kg/mt
--	--	---	---------------------------------

Profil ağırlıklarımız teorik olup; teslim anındaki tartımız geçerlidir.
Profile weights are theoretical and the weight at the time of delivery is valid.

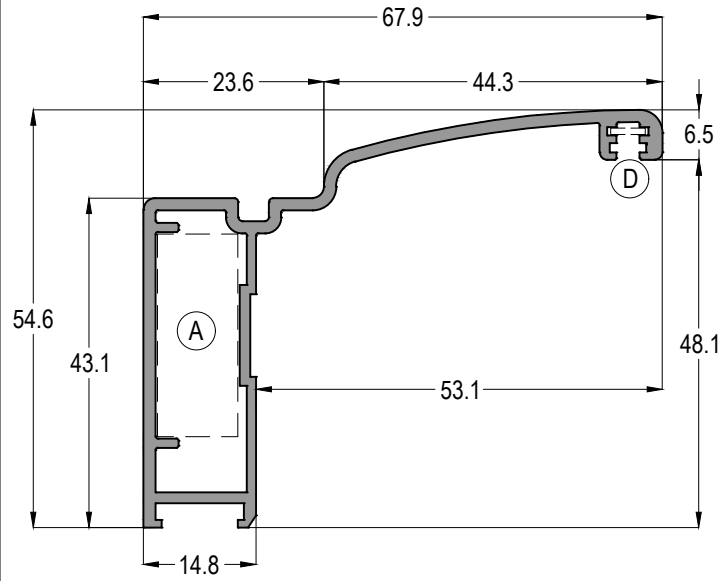
INTERNO KAPI - DEKORATİF PERVAZLI SERİ INTERNO DOOR - DECORATIVE SERIAL



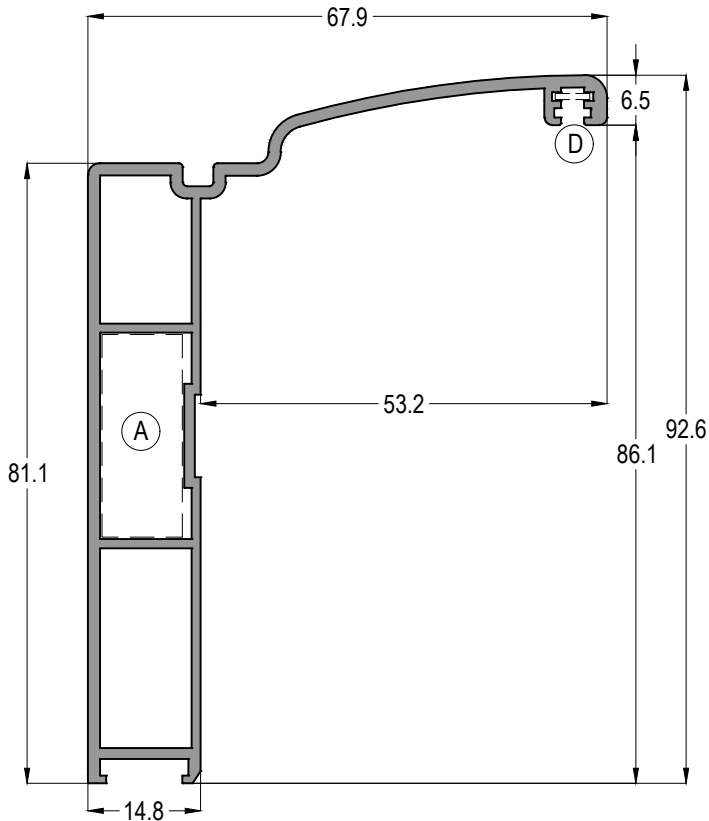

BR24-12

 (A)	 (D)	AĞIRLIK / Weight 0,770 kg/mt
ASI-KT 1126 ~ ASI-PB 1126	ASI-SB 19	





BR24-13

 (A)	 (D)	AĞIRLIK / Weight 1,117 kg/mt
ASI-KT 1126 ~ ASI-PB 1126	ASI-SB 19	

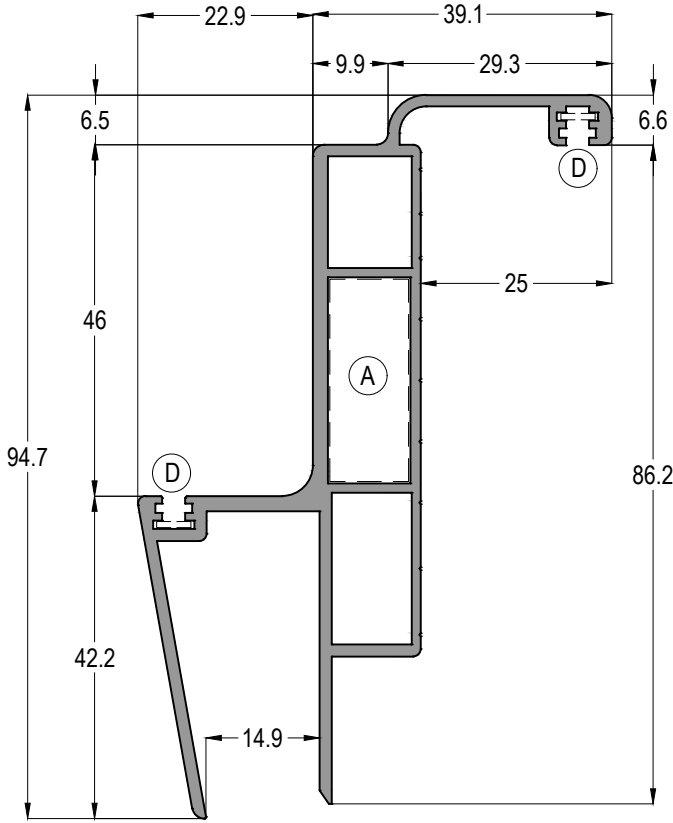
INTERNO KAPI - DAR PERVAZLI SERİ INTERNO DOOR - NARROW SERIAL



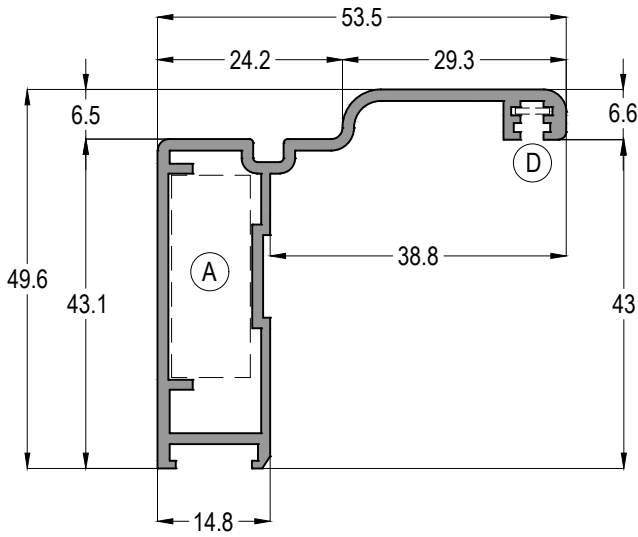

BR24-14

 ASI-PB 1126	 ASI-SB 19	AĞIRLIK / Weight 1,331 kg/mt
---	--	---------------------------------



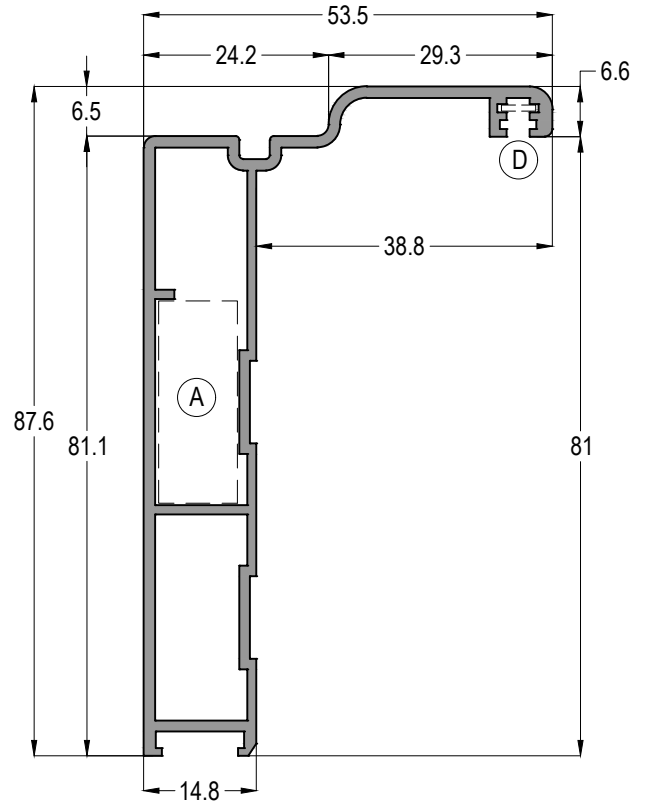

BR24-15

 ASI-PB 1126	 ASI-SB 19	AĞIRLIK / Weight 0,681 kg/mt
--	--	---------------------------------



BR24-16

 ASI-PB 1126	 ASI-SB 19	AĞIRLIK / Weight 1,003 kg/mt
---	--	---------------------------------

INTERNO KAPI

İÇ MEKAN KAPI SİSTEMİ
INDOOR DOOR SYSTEM

ASISTAL

INTERNO KAPI - GENİŞ PERVAZLI SERİ INTERNO DOOR - WIDE SERIAL

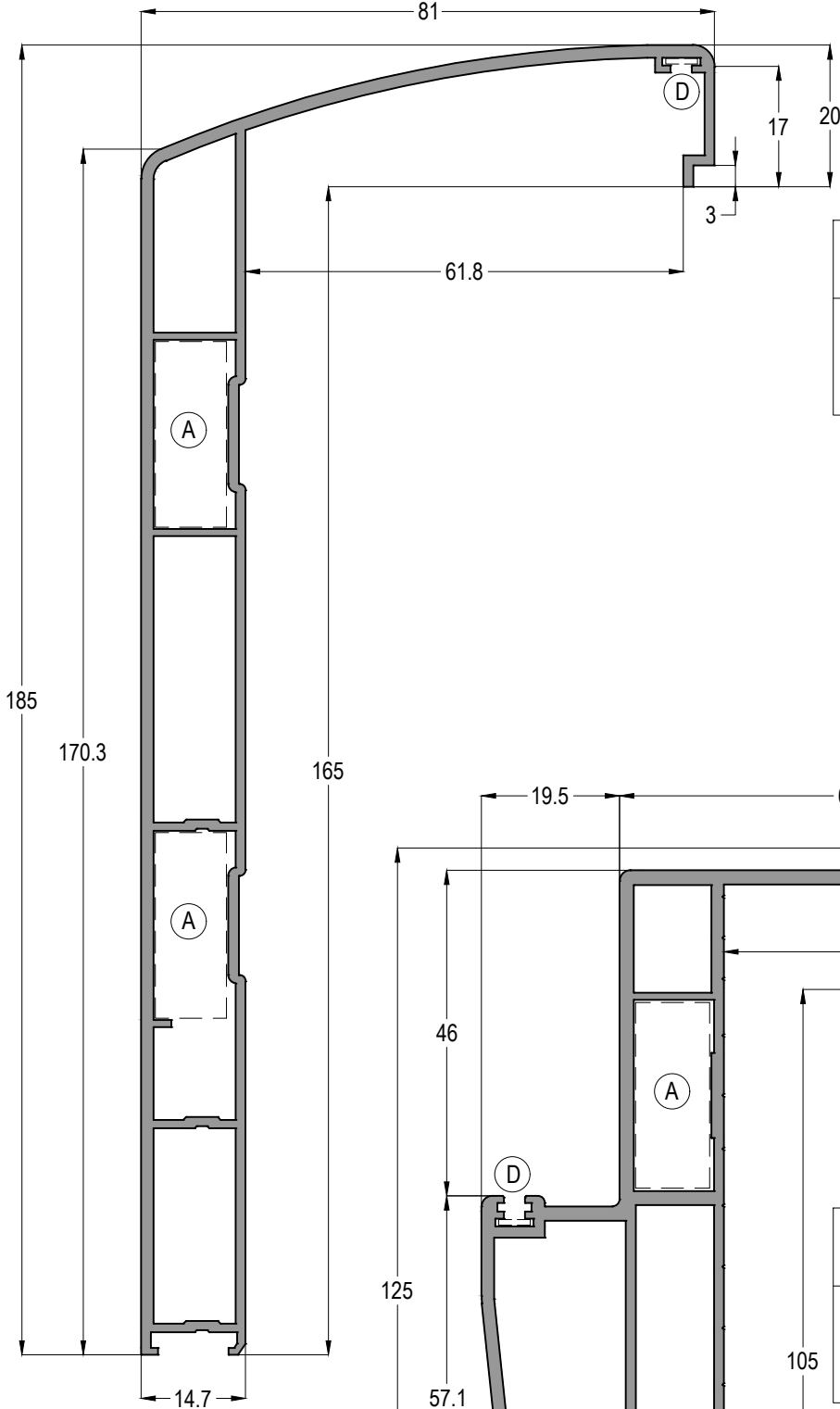

BR24-17



ASI-PB 1126



ASI-SB 19

AĞIRLIK / Weight

2,151 kg/mt

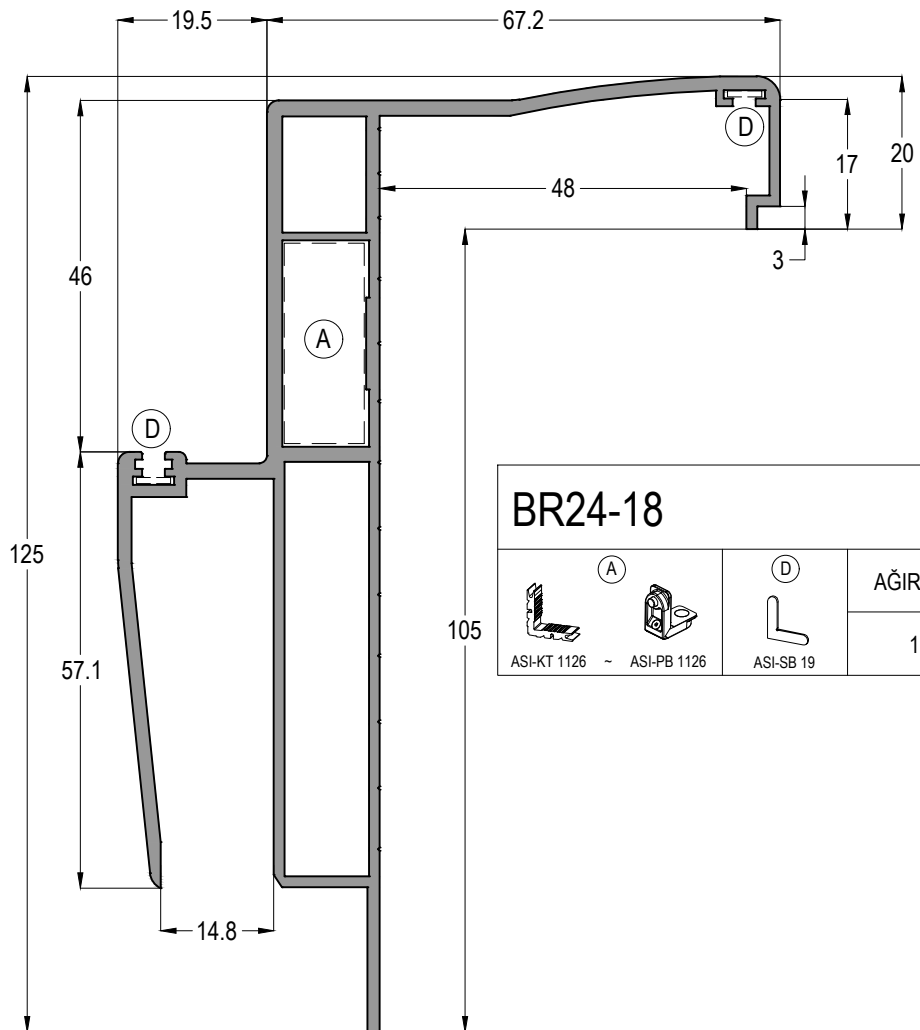

BR24-18



ASI-KT 1126



ASI-PB 1126



ASI-SB 19



AĞIRLIK / Weight

1,916 kg/mt

INTERNO KAPI - EKONOMİK PERVAZLI SERİ

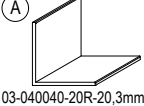

INTERNO DOOR - ECONOMIC SERIAL

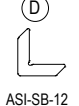
BR24-32

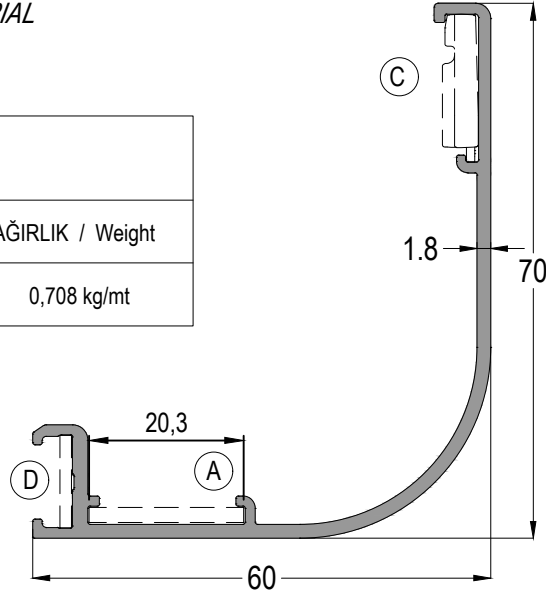
			AĞIRLIK / Weight
03-040040-20R-20,3mm	ASI-FUJJI 2000	ASI-SB-12	0,708 kg/mt



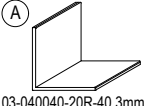

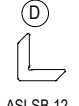
BR24-33

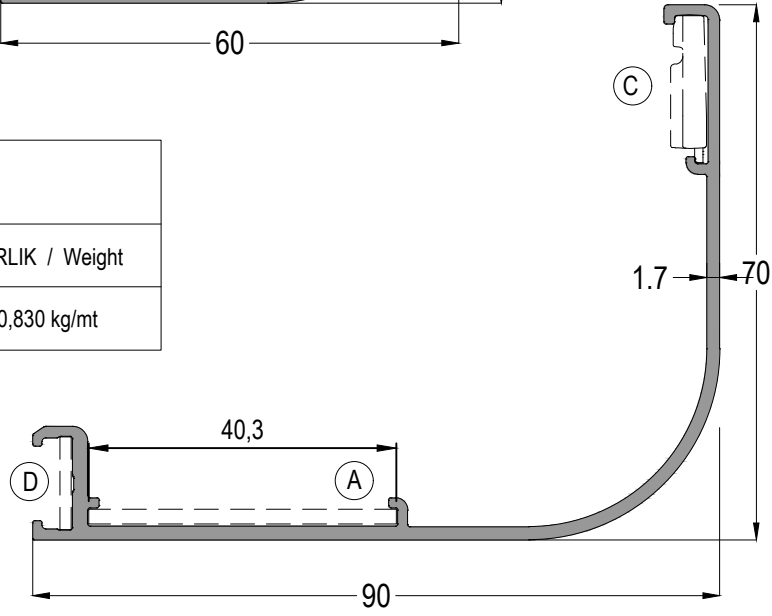
			AĞIRLIK / Weight
03-040040-20R-40,3mm	ASI-FUJJI 2000	ASI-SB-12	0,830 kg/mt

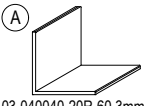

BR24-34

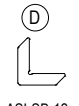
			AĞIRLIK / Weight
03-040040-20R-60,3mm	ASI-FUJJI 2000	ASI-SB-12	0,949 kg/mt

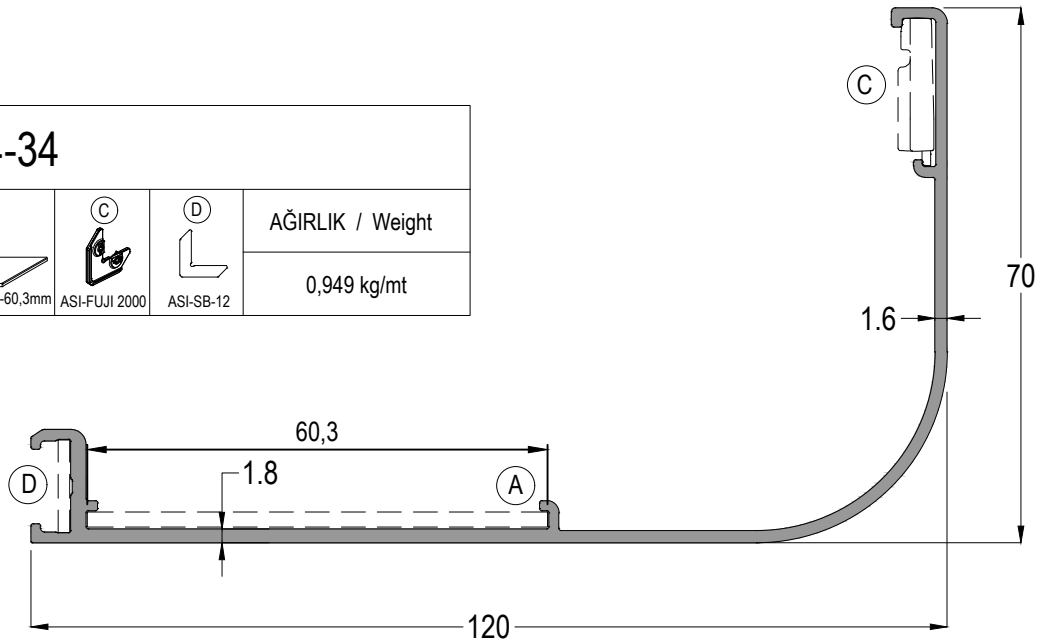

Profil ağırlıklarımız teorik olup; teslim anındaki tartımız geçerlidir.

Profile weights are theoretical and the weight at the time of delivery is valid.

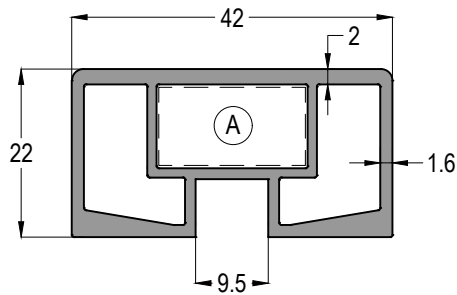

BR24-21



AĞIRLIK / Weight

0,788 kg/mt

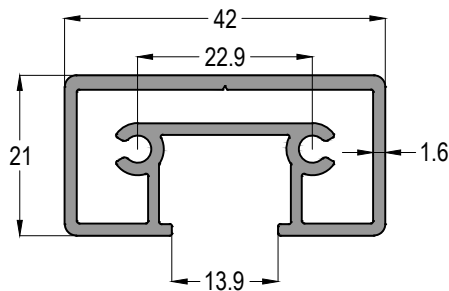

BR24-24

AĞIRLIK / Weight

0,729 kg/mt

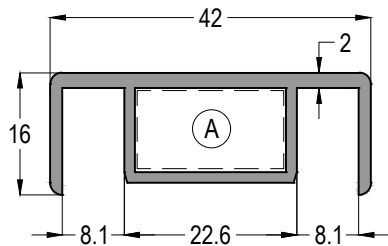

BR24-22



AĞIRLIK / Weight

0,518 kg/mt

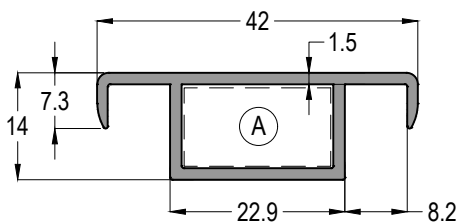

BR24-23



AĞIRLIK / Weight

0,391 kg/mt

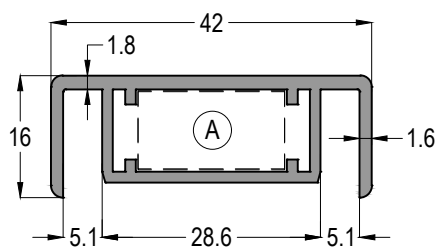

BR24-28



AĞIRLIK / Weight



0,540 kg/mt

INTERNO KAPI

İÇ MEKAN KAPI SİSTEMİ
INDOOR DOOR SYSTEM

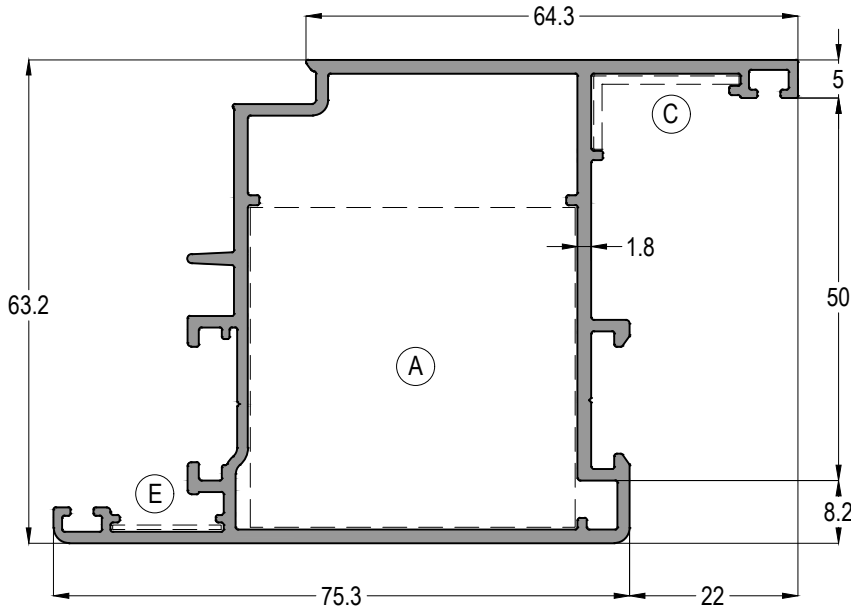
ASISTAL



C55 13		Jx cm ⁴	Jy cm ⁴
		32,85	33,22
			AĞIRLIK / Weight
1,472 kg/mt			

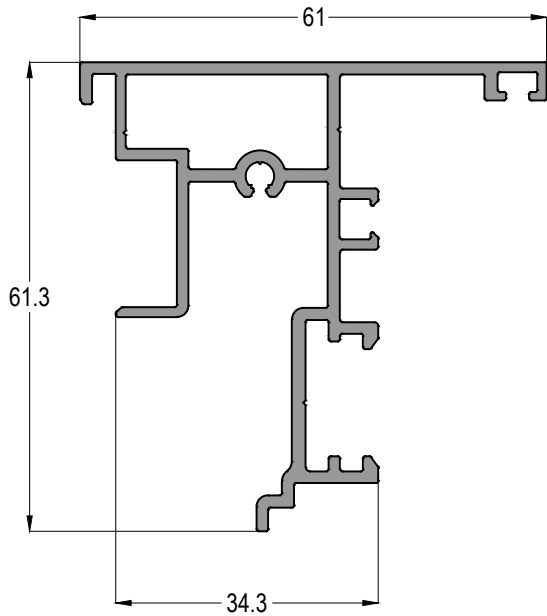

C55 41

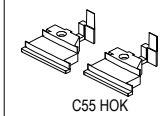

C55 HOK

AĞIRLIK / Weight

1,037 kg/mt

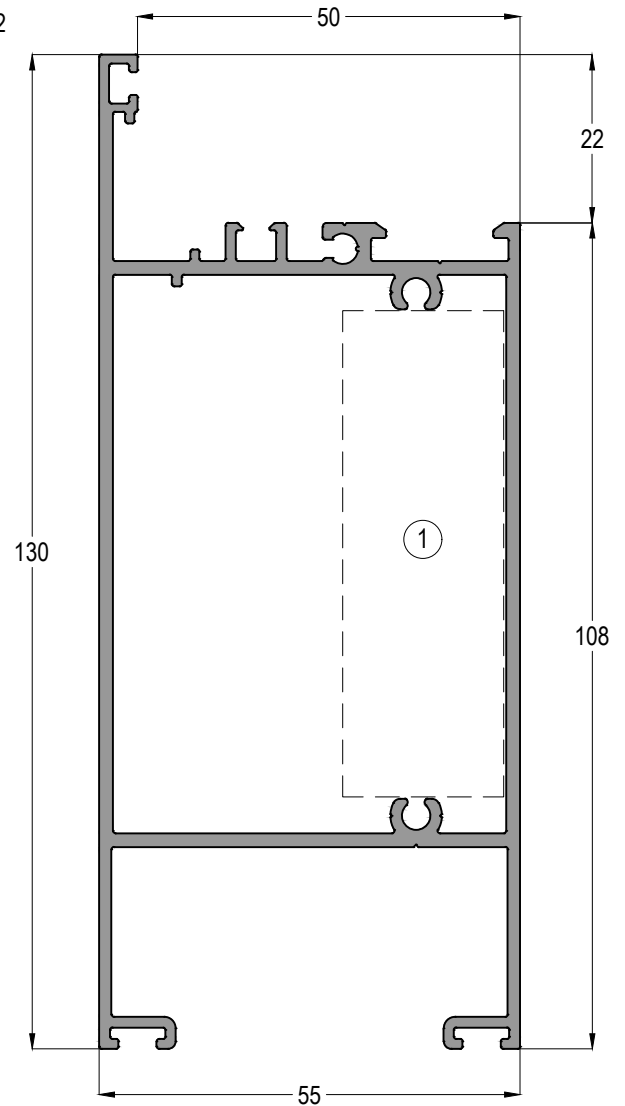

C55 31

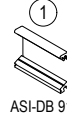

ASI-DB 9164

Jx cm⁴

Jy cm⁴

104,06

36,64

AĞIRLIK / Weight

1,941 kg/mt

Profil ağırlıklarımız teorik olup; teslim anındaki tartımız geçerlidir.



Profile weights are theoretical and the weight at the time of delivery is valid.

INTERNO KAPI

İÇ MEKAN KAPI SİSTEMİ
INDOOR DOOR SYSTEM

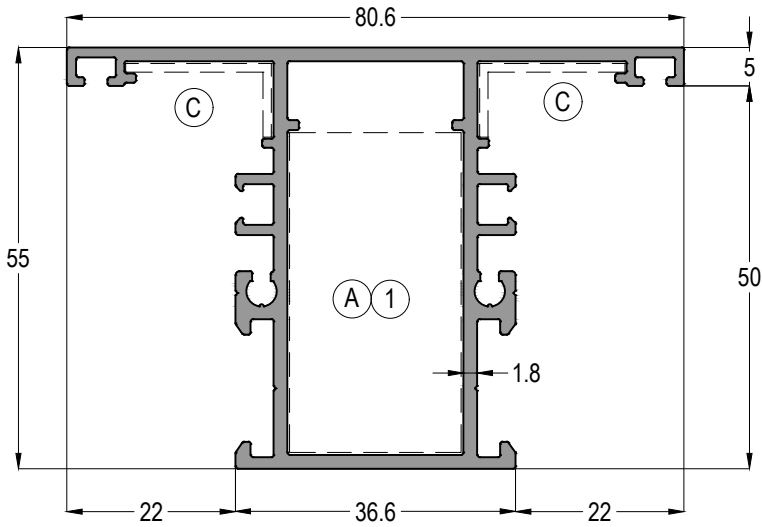
ASISTAL



C55 22			Jx cm ⁴	Jy cm ⁴
			19,44	15,87
			AĞIRLIK / Weight	
			1,337 kg/mt	

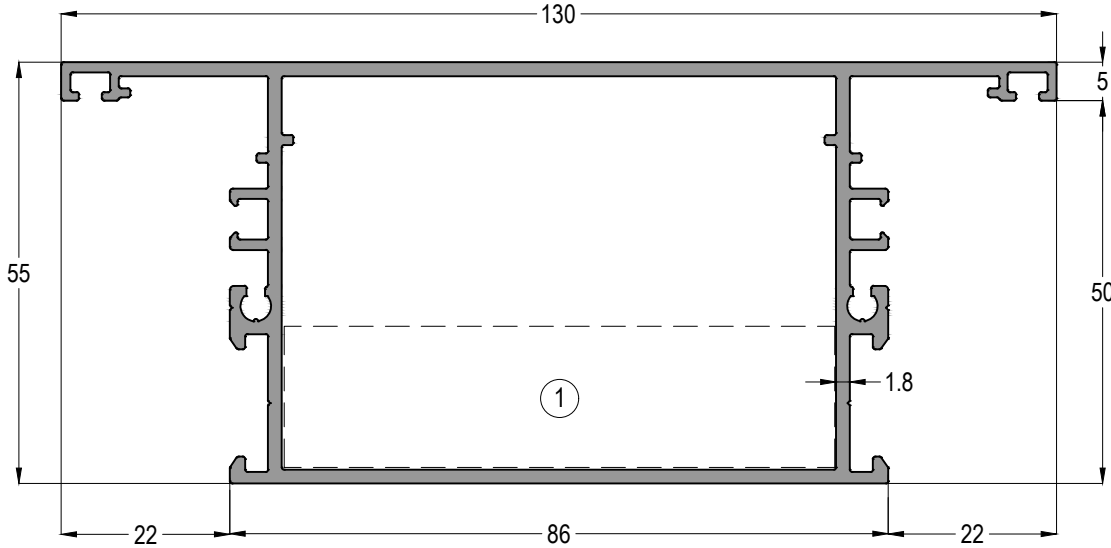

C55 23			Jx cm ⁴	Jy cm ⁴
			32,36	88,07
			AĞIRLIK / Weight	
			1,817 kg/mt	

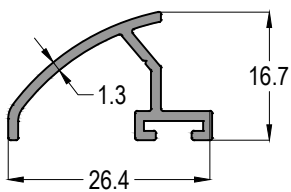

12-01	
	AĞIRLIK / Weight
	0,198 kg/mt

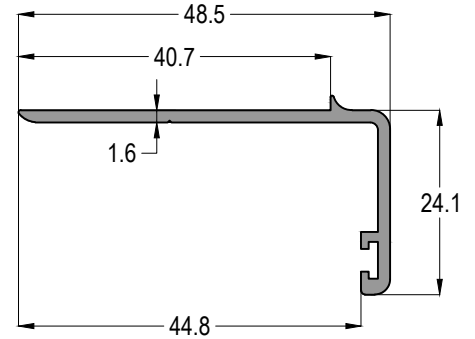

BR24-31	
	AĞIRLIK / Weight
	0,331 kg/mt

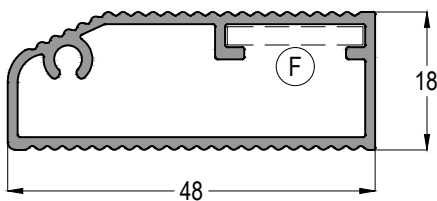

12-33	
	AĞIRLIK / Weight
	0,412 kg/mt

Profil ağırlıklarımız teorik olup; teslim anındaki tartımız geçerlidir.
Profile weights are theoretical and the weight at the time of delivery is valid.

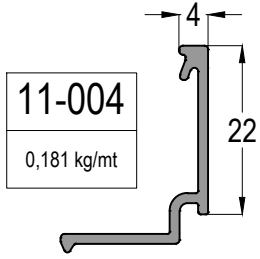

11-004

0,181 kg/mt

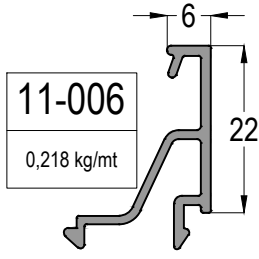

11-006

0,218 kg/mt

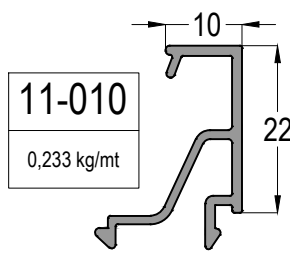

11-010

0,233 kg/mt

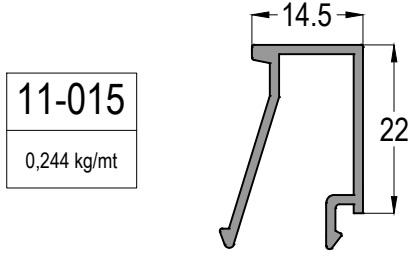

11-015

0,244 kg/mt

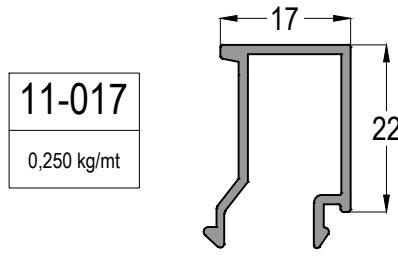

11-017

0,250 kg/mt

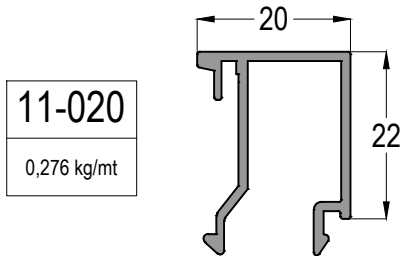

11-020

0,276 kg/mt

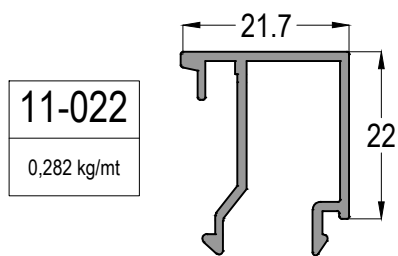

11-022

0,282 kg/mt

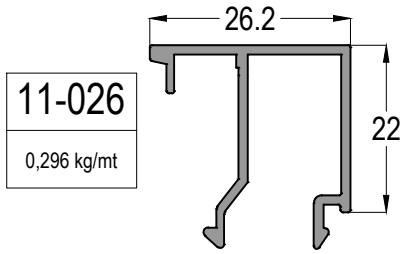

11-026

0,296 kg/mt

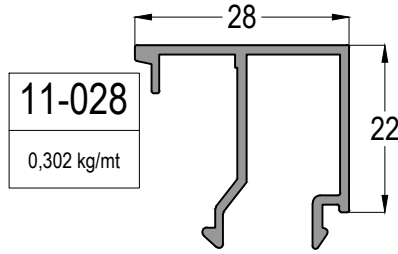

11-028

0,302 kg/mt

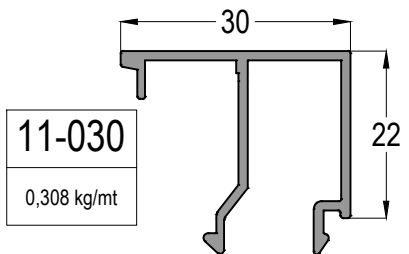

11-030

0,308 kg/mt

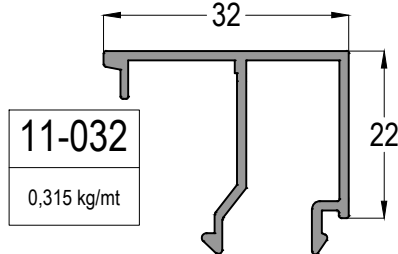

11-032

0,315 kg/mt

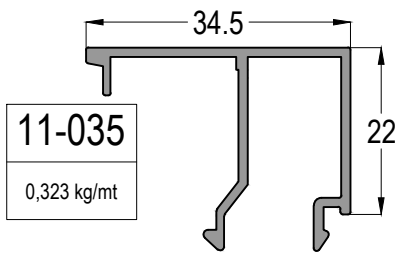

11-035

0,323 kg/mt

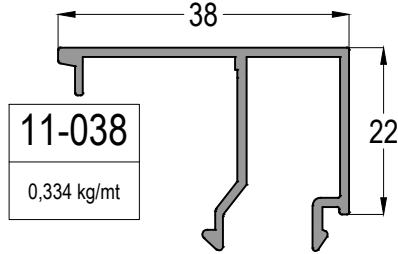

11-038

0,334 kg/mt

CAM KALINLIĞINA GÖRE CAM ÇİTASI SEÇİM TABLOSU
Glazing Bead Selection Table
according to the Glass Thickness

CAM KALINLIĞI Glass Thickness (mm)	CAM ÇİTASI Glazing Bead	İÇ CAM FİTİLİ Glass Gasket (IN)	DIŞ CAM FİTİLİ Glass Gasket (OUT)
4	11-038	EP2-03	EP1-01
5	11-038	EP2-02	EP1-01
6	11-038	EP2-01	EP1-01
7	11-035	EP2-03	EP1-01
8	11-035	EP2-02	EP1-01
9	11-035	EP2-01	EP1-01
10	11-032	EP2-03	EP1-01
11	11-032	EP2-02	EP1-01
12	11-032	EP2-01	EP1-01
13	11-030	EP2-02	EP1-01
14	11-030	EP2-01	EP1-01
15	11-028	EP2-02	EP1-01
16	11-028	EP2-01	EP1-01
17	11-026	EP2-02	EP1-01
18	11-026	EP2-01	EP1-01
20	11-022	EP2-03	EP1-01
21	11-022	EP2-02	EP1-01
22	11-022	EP2-01	EP1-01
23	11-020	EP2-02	EP1-01
24	11-020	EP2-01	EP1-01
26	11-017	EP2-02	EP1-01
27	11-017	EP2-01	EP1-01
28	11-015	EP2-02	EP1-01
29	11-015	EP2-01	EP1-01
32	11-010	EP2-03	EP1-01
33	11-010	EP2-02	EP1-01
34	11-010	EP2-01	EP1-01
36	11-006	EP2-03	EP1-01
37	11-006	EP2-02	EP1-01
38	11-006	EP2-01	EP1-01
39	11-004	EP2-02	EP1-01
40	11-004	EP2-01	EP1-01

Profil ağırlıklarımız teorik olup; teslim anındaki tartımız geçerlidir.

Profile weights are theoretical and the weight at the time of delivery is valid.

SİSTEM DETAYLARI
SYSTEM DETAILS

INTERNO KAPI - DÜZ PERVAZLI SERİ INTERNO DOOR - FLAT SERIAL

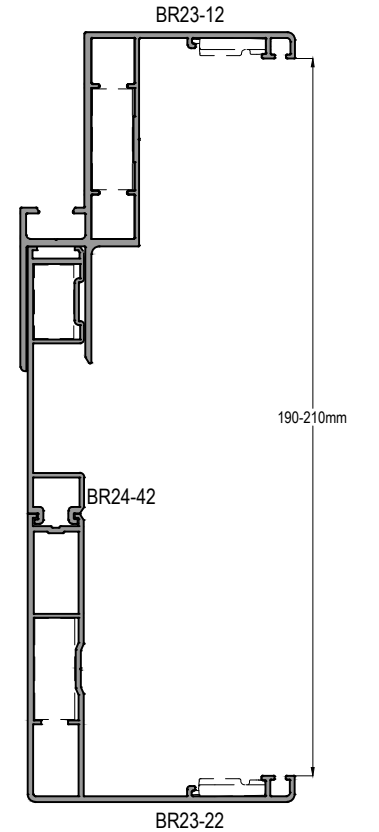
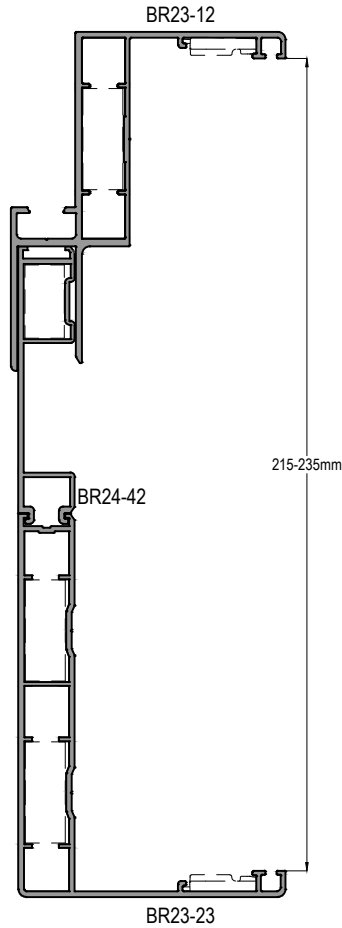
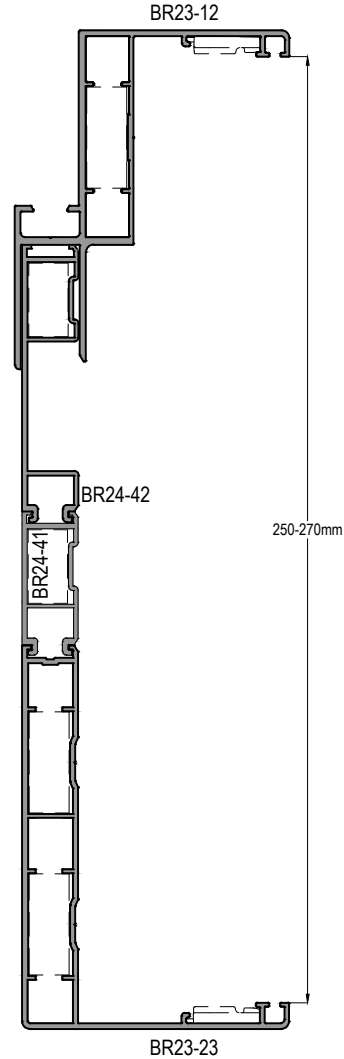
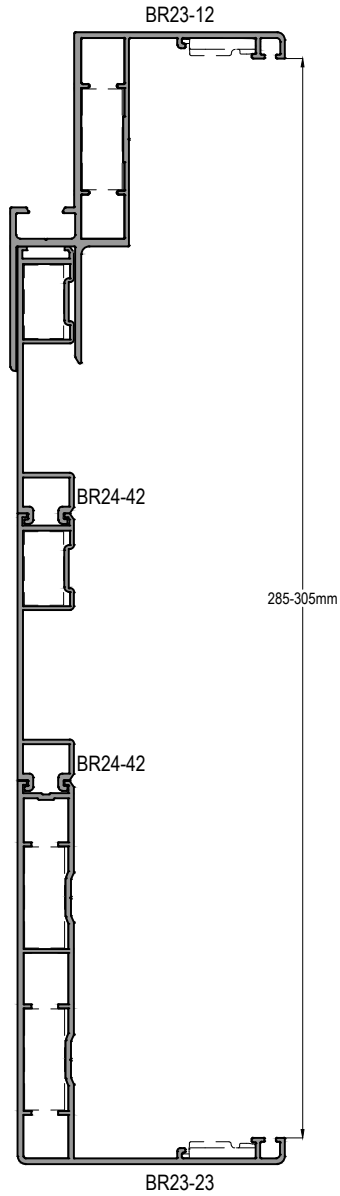
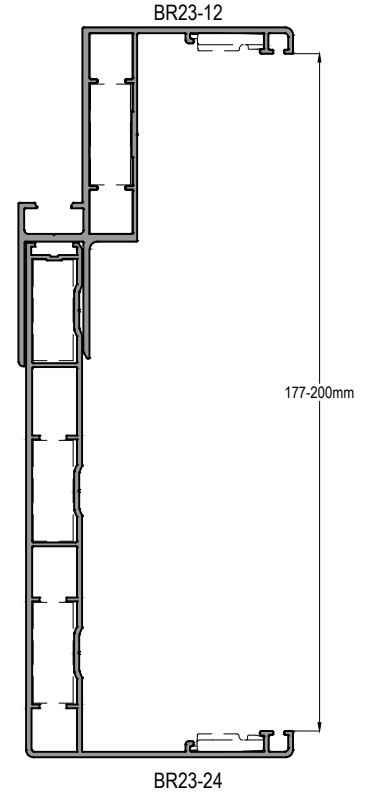
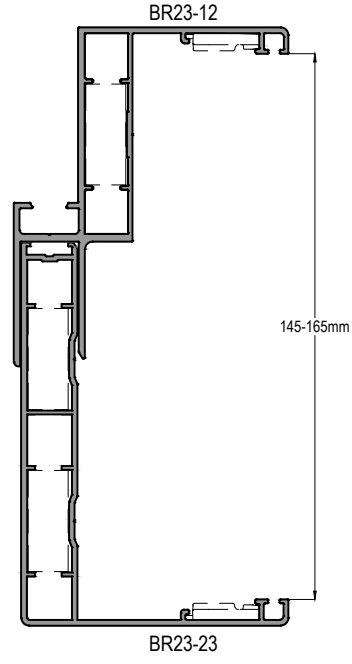
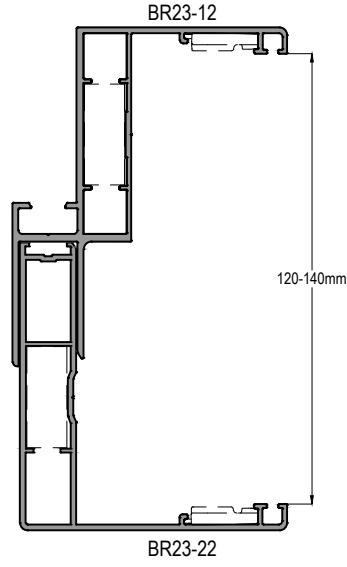
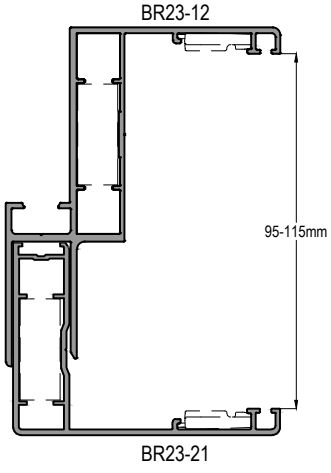

INTERNO KAPI - DÜZ PERVAZLI SERİ

INTERNO DOOR - FLAT SERIAL

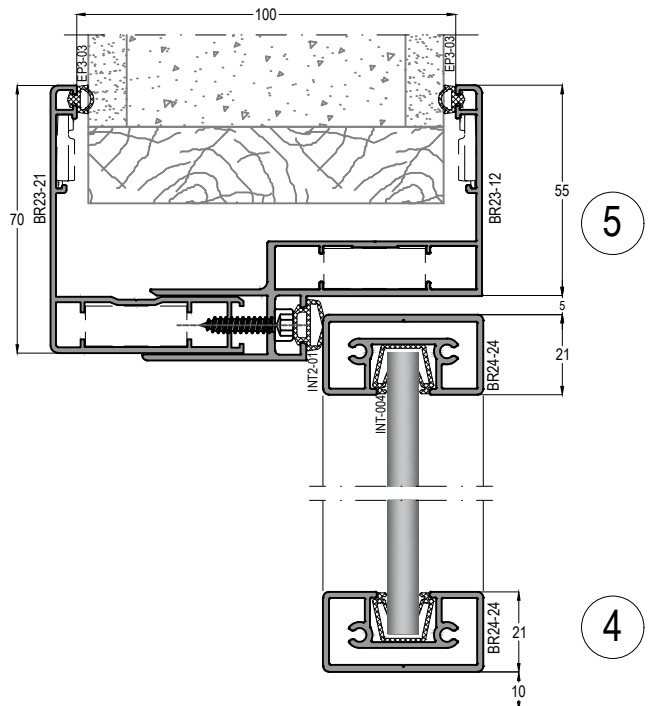
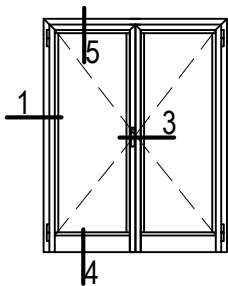
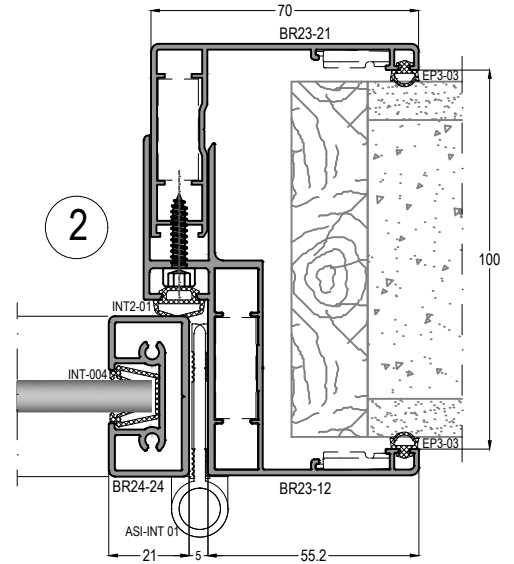
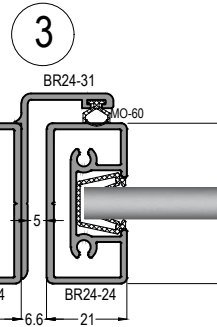
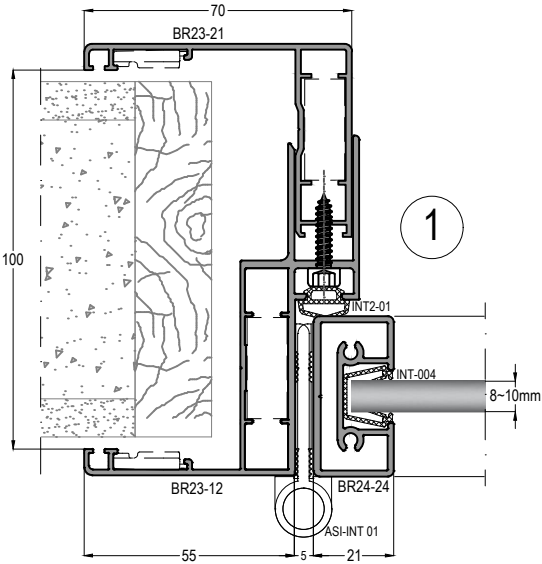
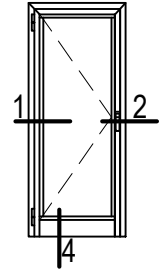
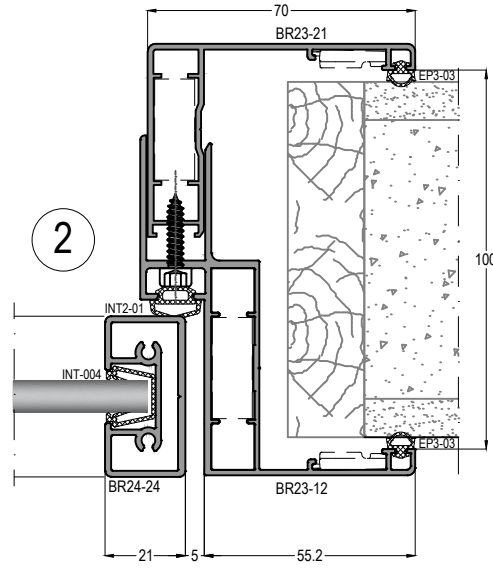
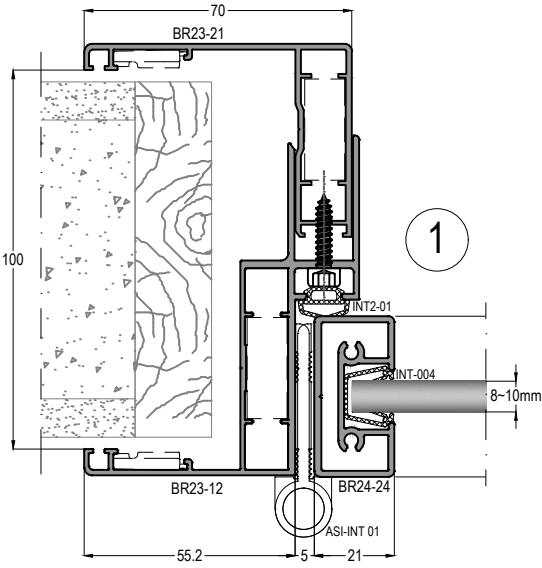

INTERNO KAPI - DÜZ PERVAZLI SERİ (ALÜMİNYUM KAPI UYGULAMALI) INTERNO DOOR - FLAT SERIAL (ALUMINIUM DOOR ASSEMBLY)

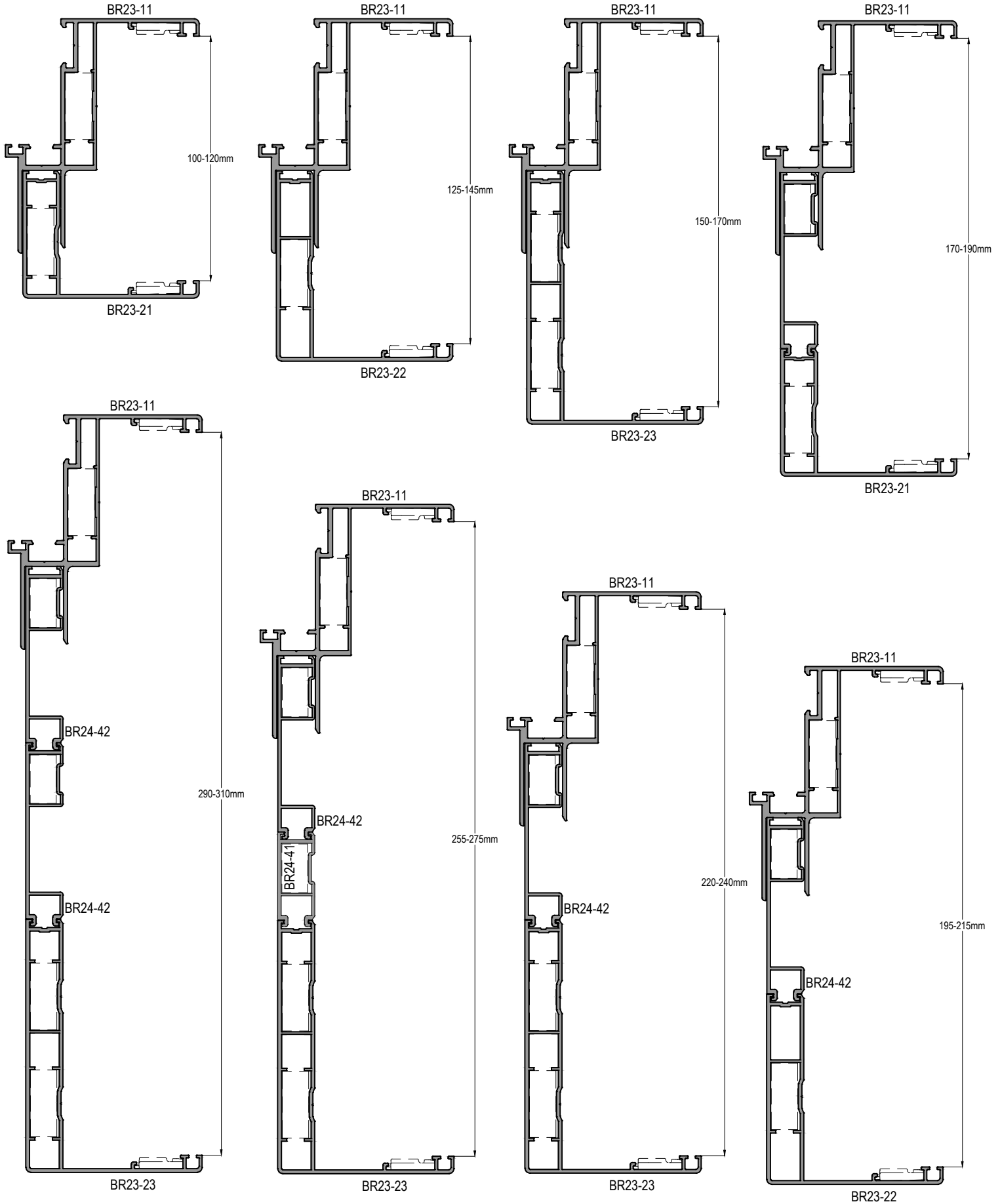

INTERNO KAPI

İÇ MEKAN KAPI SİSTEMİ
INDOOR DOOR SYSTEM

ASISTAL

INTERNO KAPI - DÜZ PERVAZLI SERİ (ALÜMİNYUM KAPI UYGULAMALI)
INTERNO DOOR - FLAT SERIAL (ALUMINIUM DOOR ASSEMBLY)

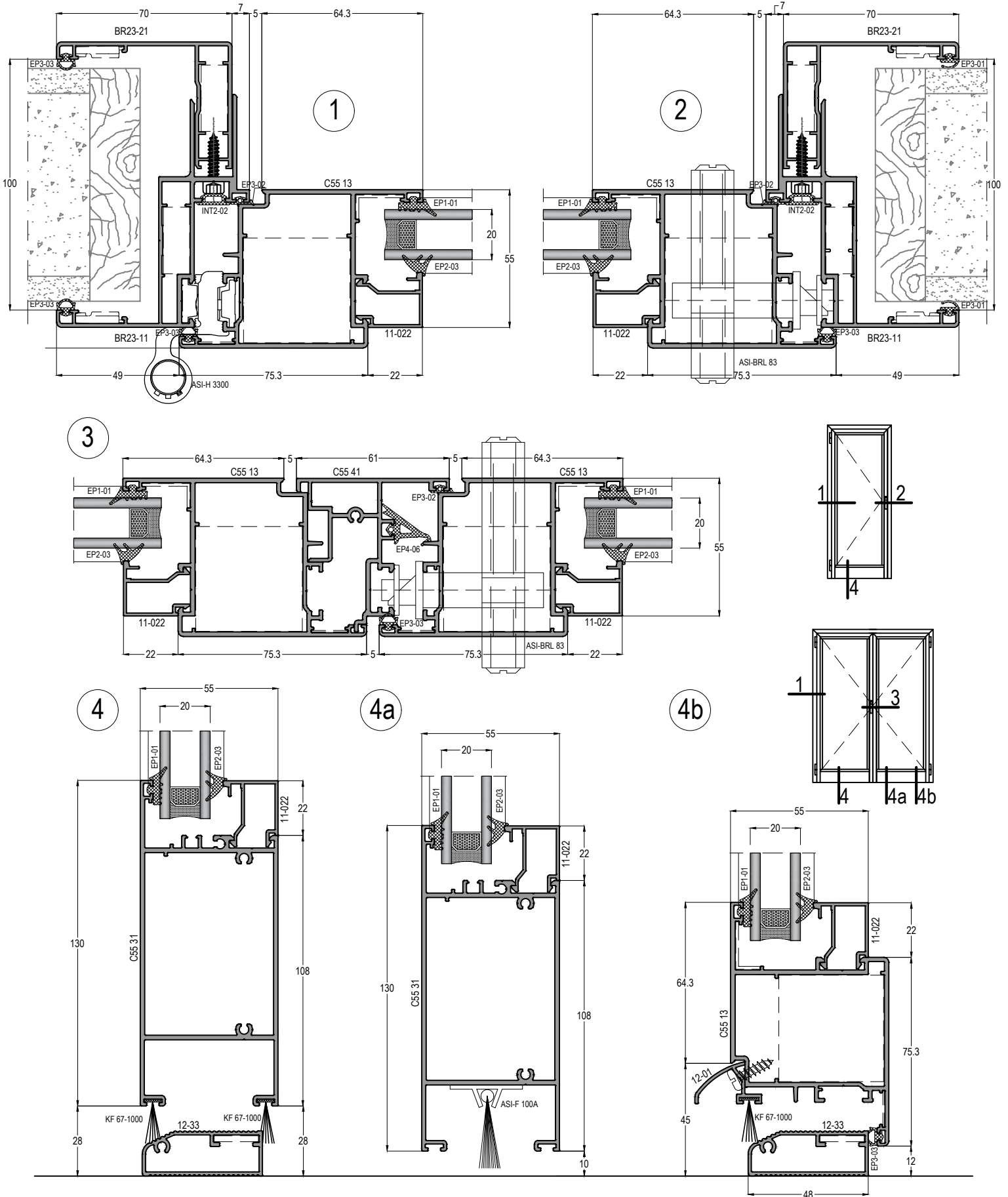

INTERNO KAPI - STANDART SERİ

INTERNO DOOR - STANDART SERIAL

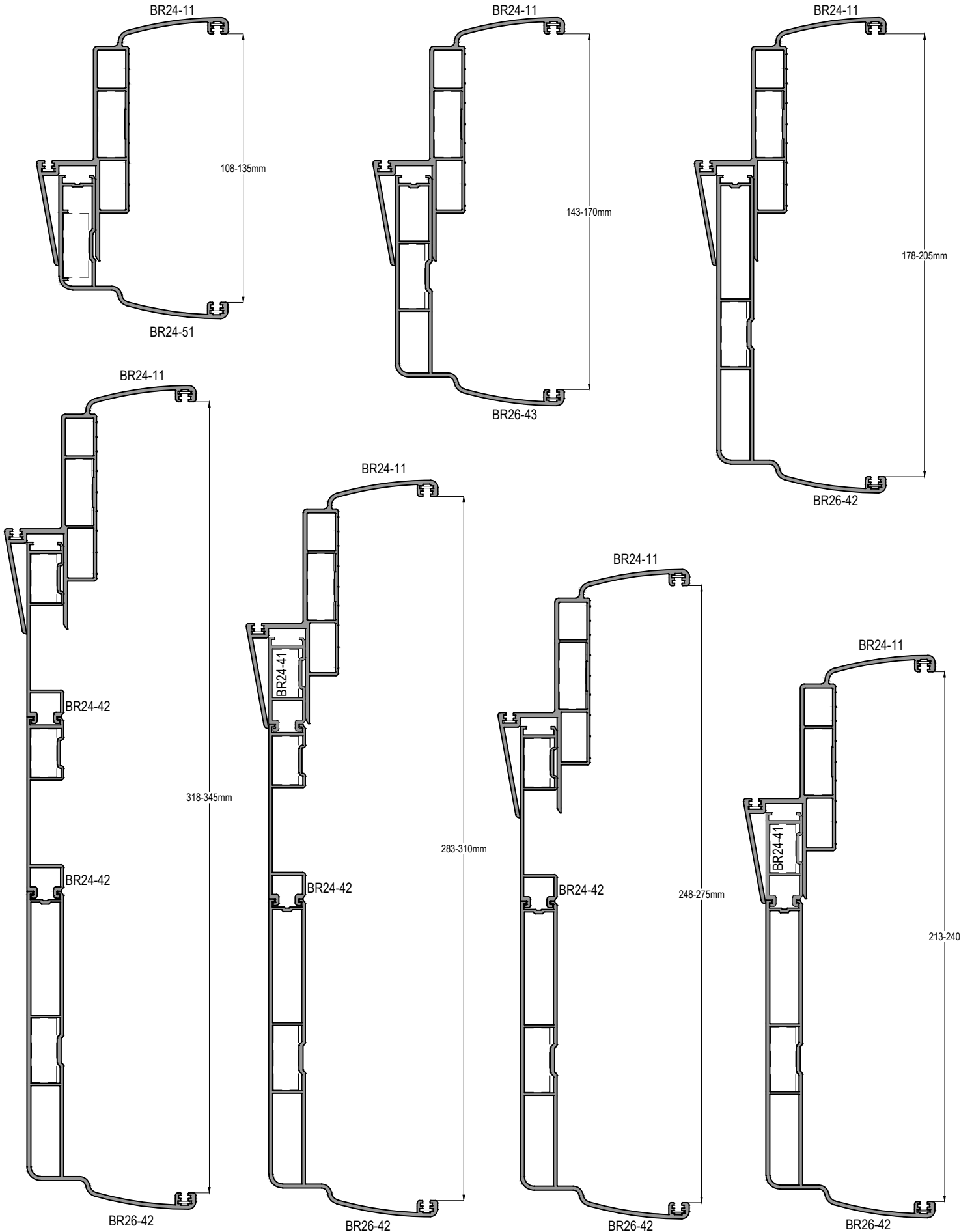

INTERNO KAPI

İÇ MEKAN KAPI SİSTEMİ
INDOOR DOOR SYSTEM



INTERNO KAPI - STANDART SERİ INTERNO DOOR - STANDART SERIAL

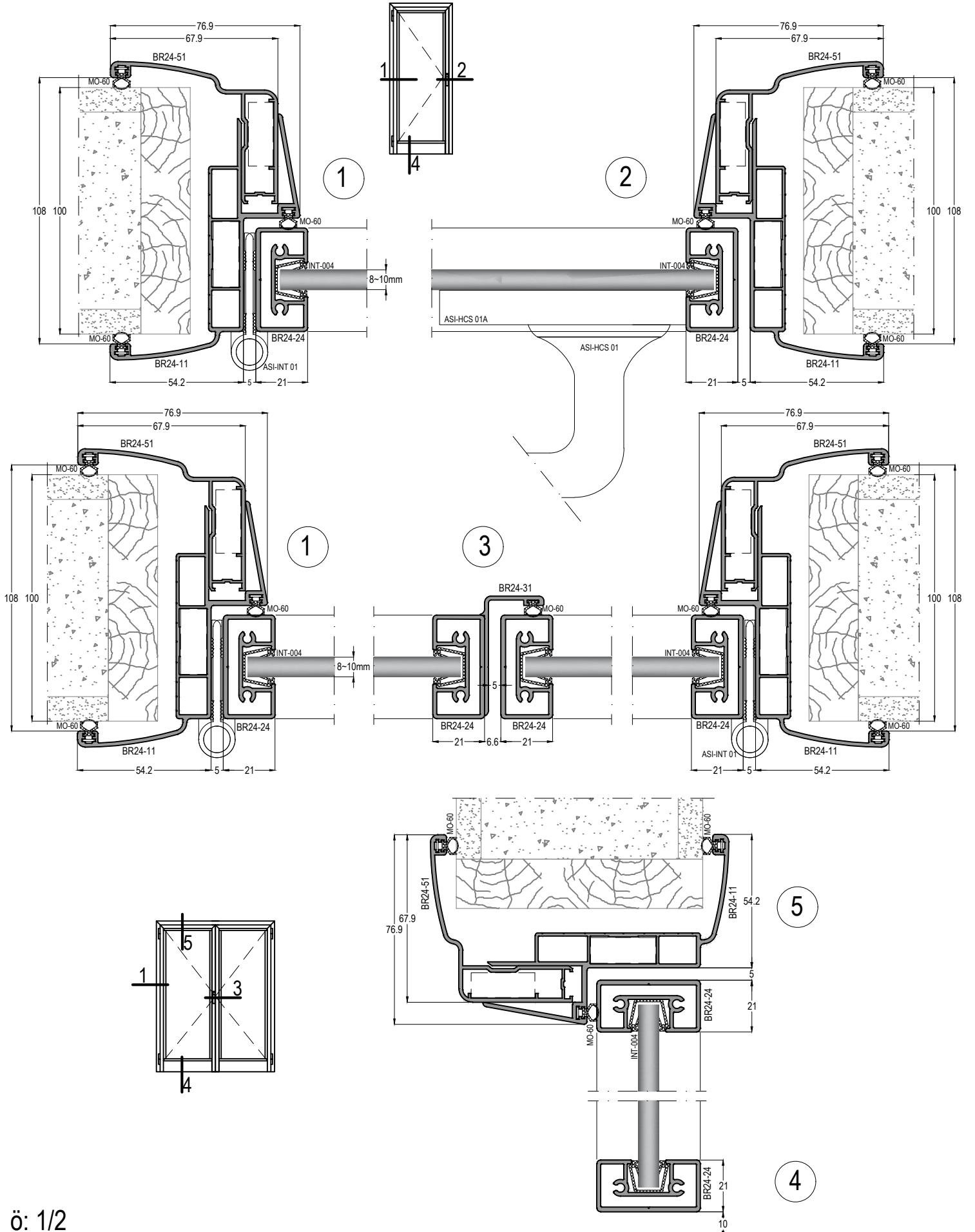

INTERNO KAPI KANAT UYGULAMA DETAYLARI

INTERNO DOOR - SASH INSTALLATION DETAILS

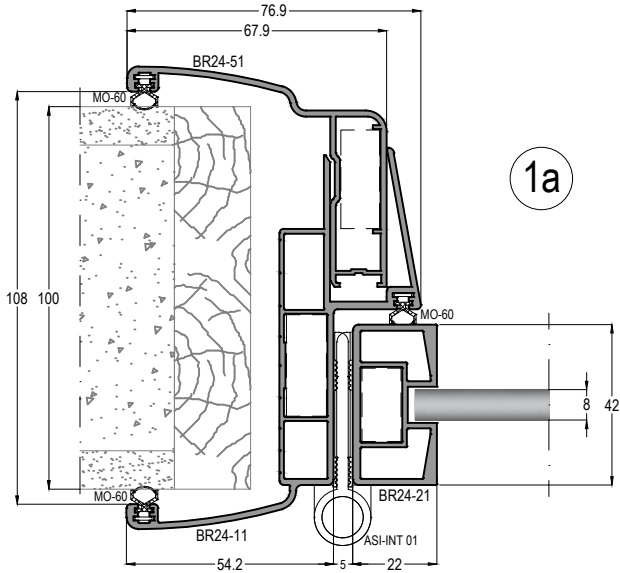

1a

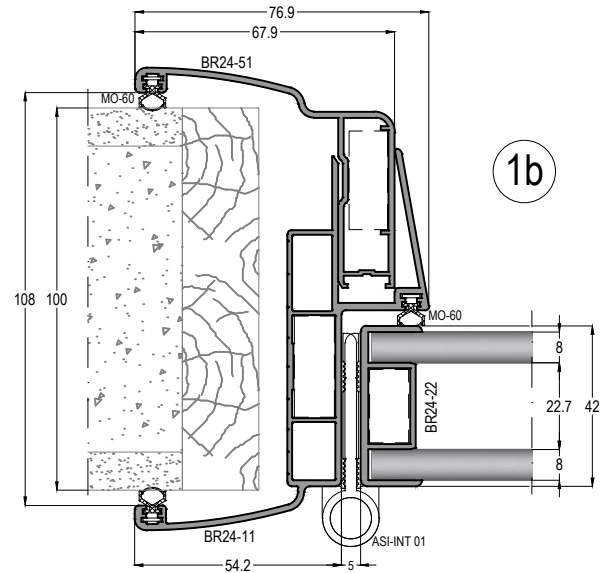

1b

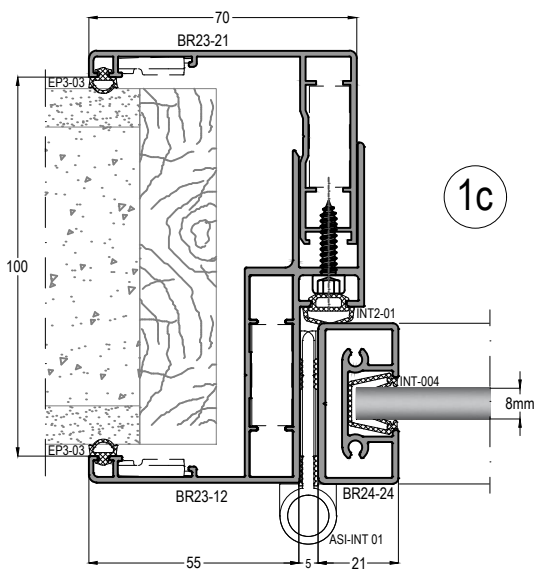

1c

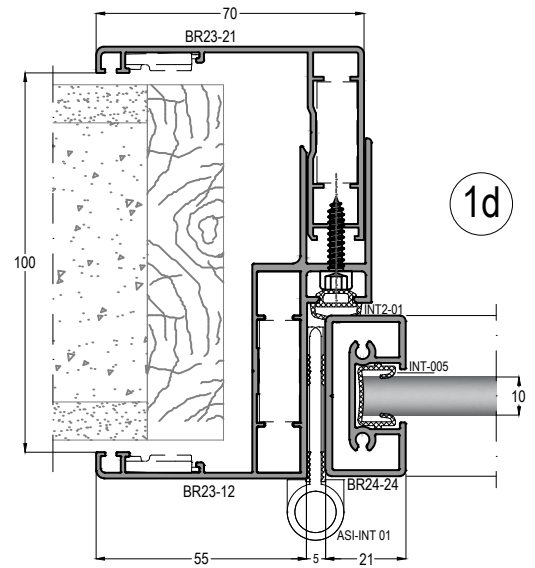

1d

INTERNO KAPI KANAT UYGULAMA DETAYLARI

INTERNO DOOR - SASH INSTALLATION DETAILS

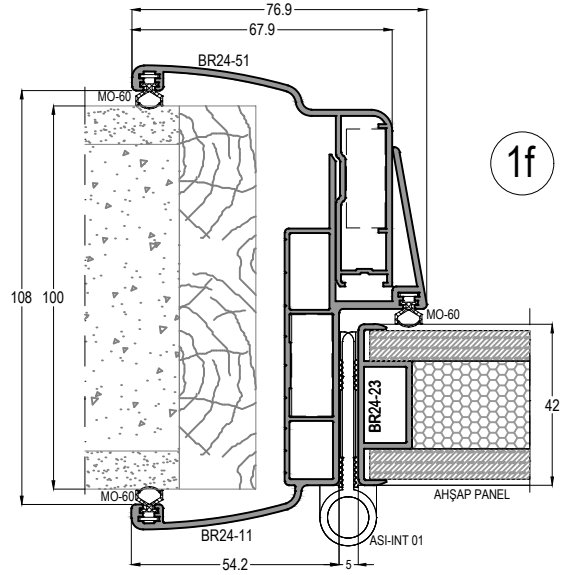
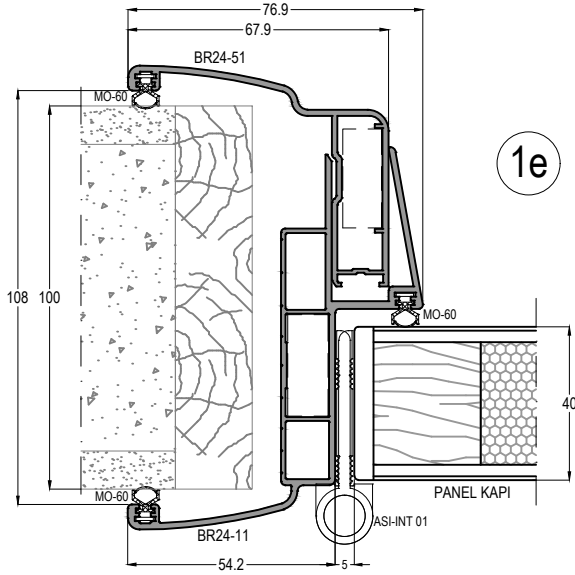

INTERNO KAPI KASA UYGULAMA DETAYI

INTERNO DOOR - FRAME INSTALLATION DETAIL

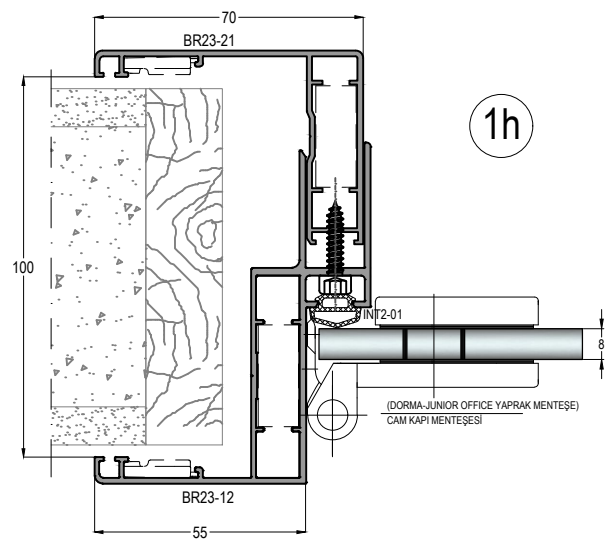
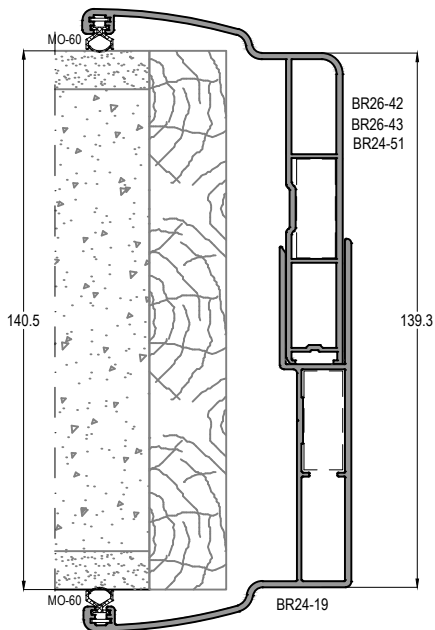

INTERNO KAPI - DEKORATİF PERVAZLI SERİ

INTERNO DOOR - DECORATIVE SERIAL

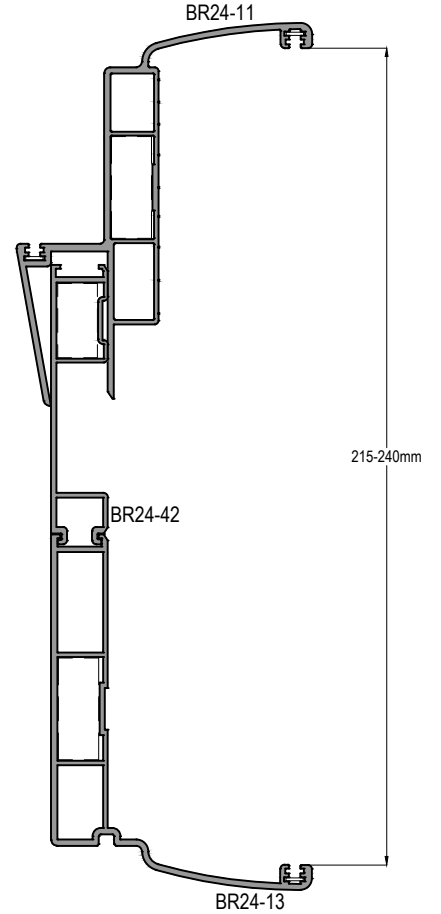
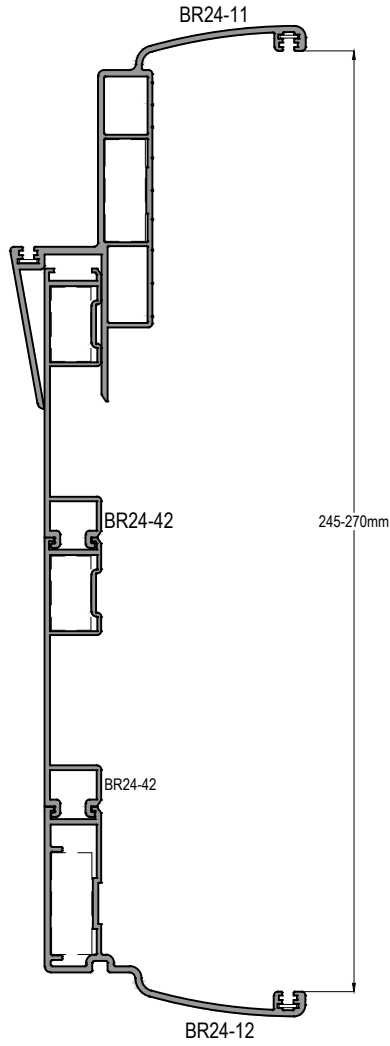
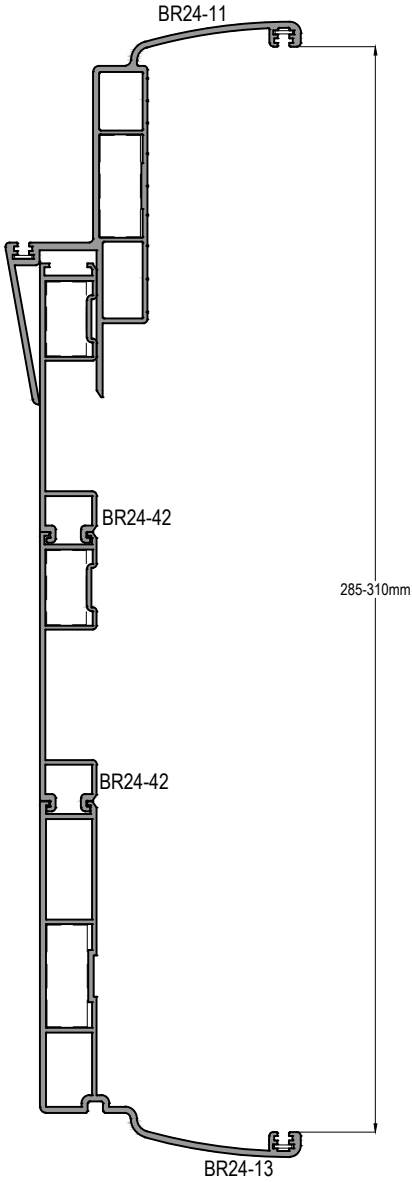
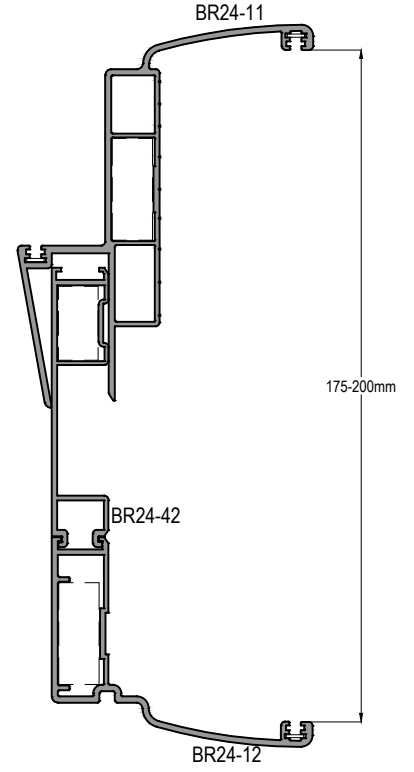
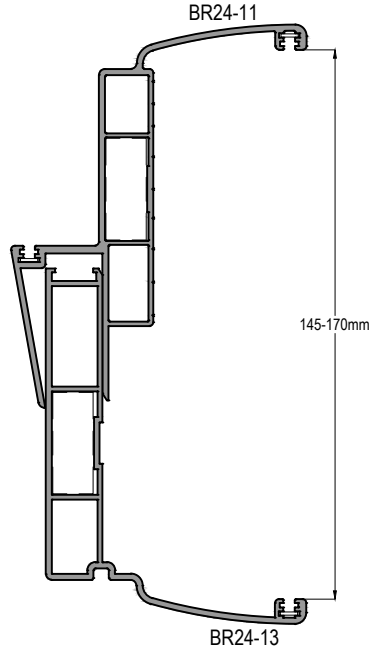
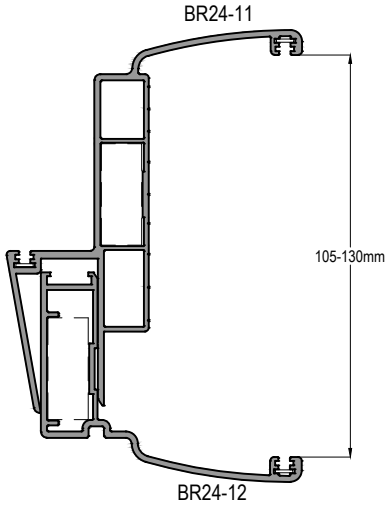

INTERNO KAPI - DEKORATİF PERVAZLI SERİ INTERNO DOOR - DECORATIVE SERIAL

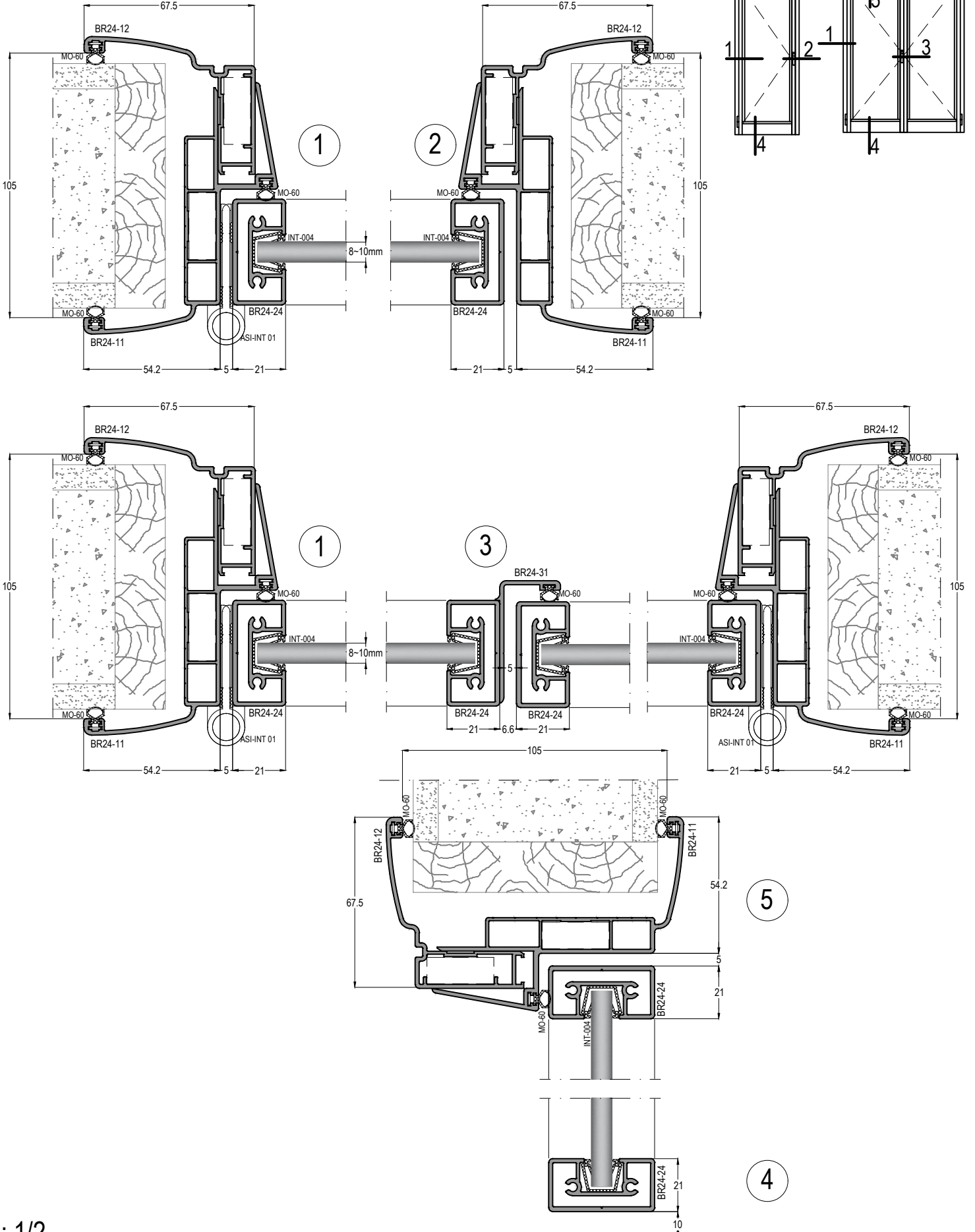

INTERNO KAPI - DAR PERVAZLI SERİ

INTERNO DOOR - NARROW SERIAL

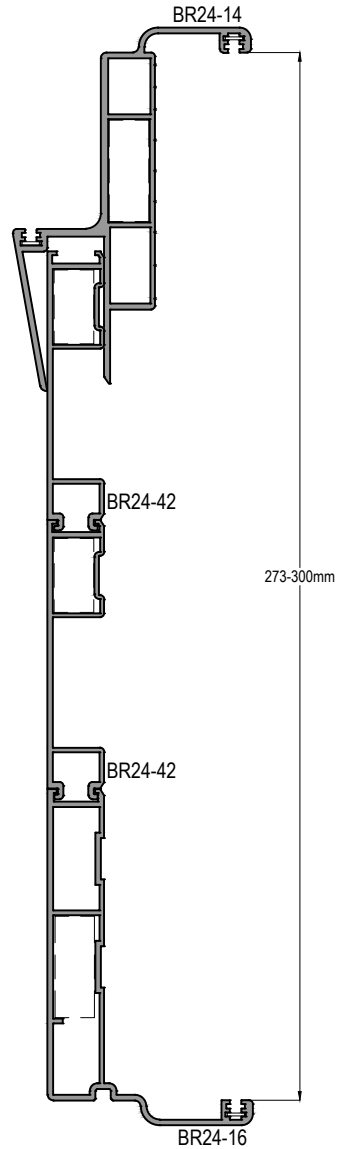
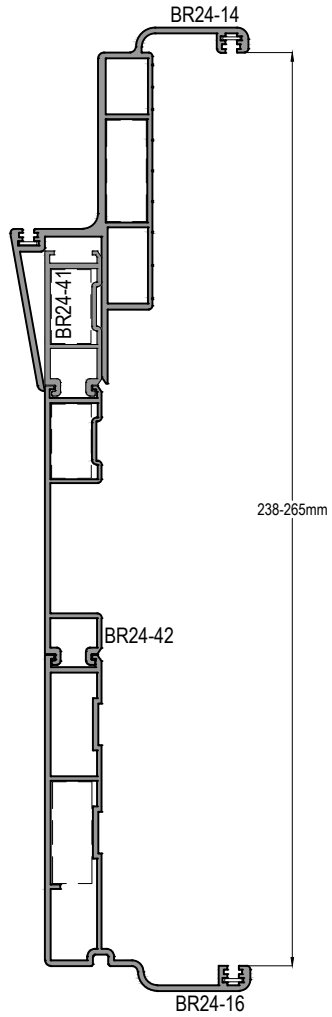
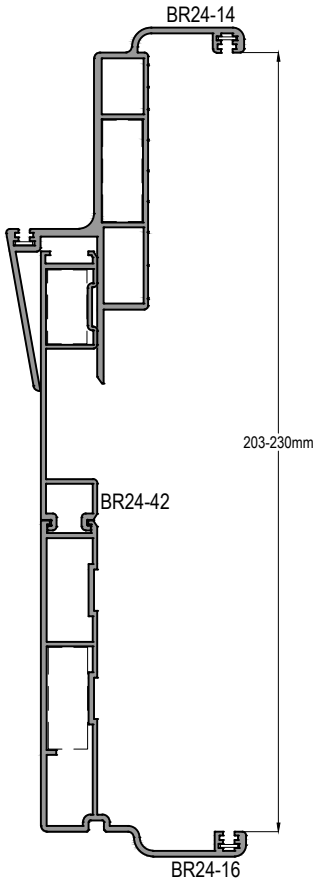
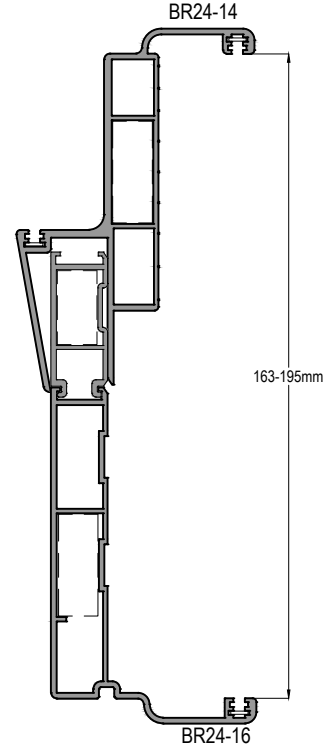
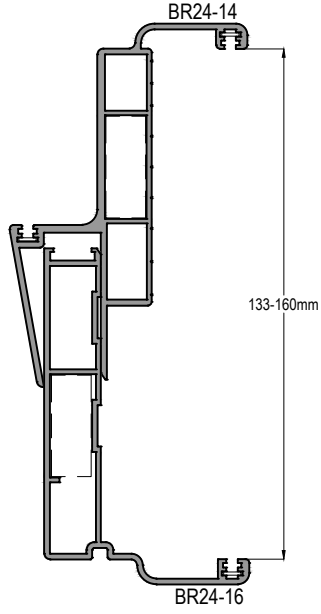
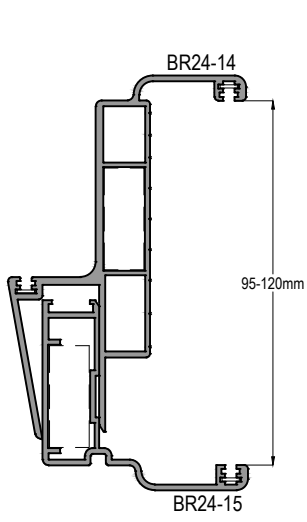

INTERNO KAPI

İÇ MEKAN KAPI SİSTEMİ
INDOOR DOOR SYSTEM



INTERNO KAPI - DAR PERVAZLI SERİ

INTERNO DOOR - NARROW SERIAL

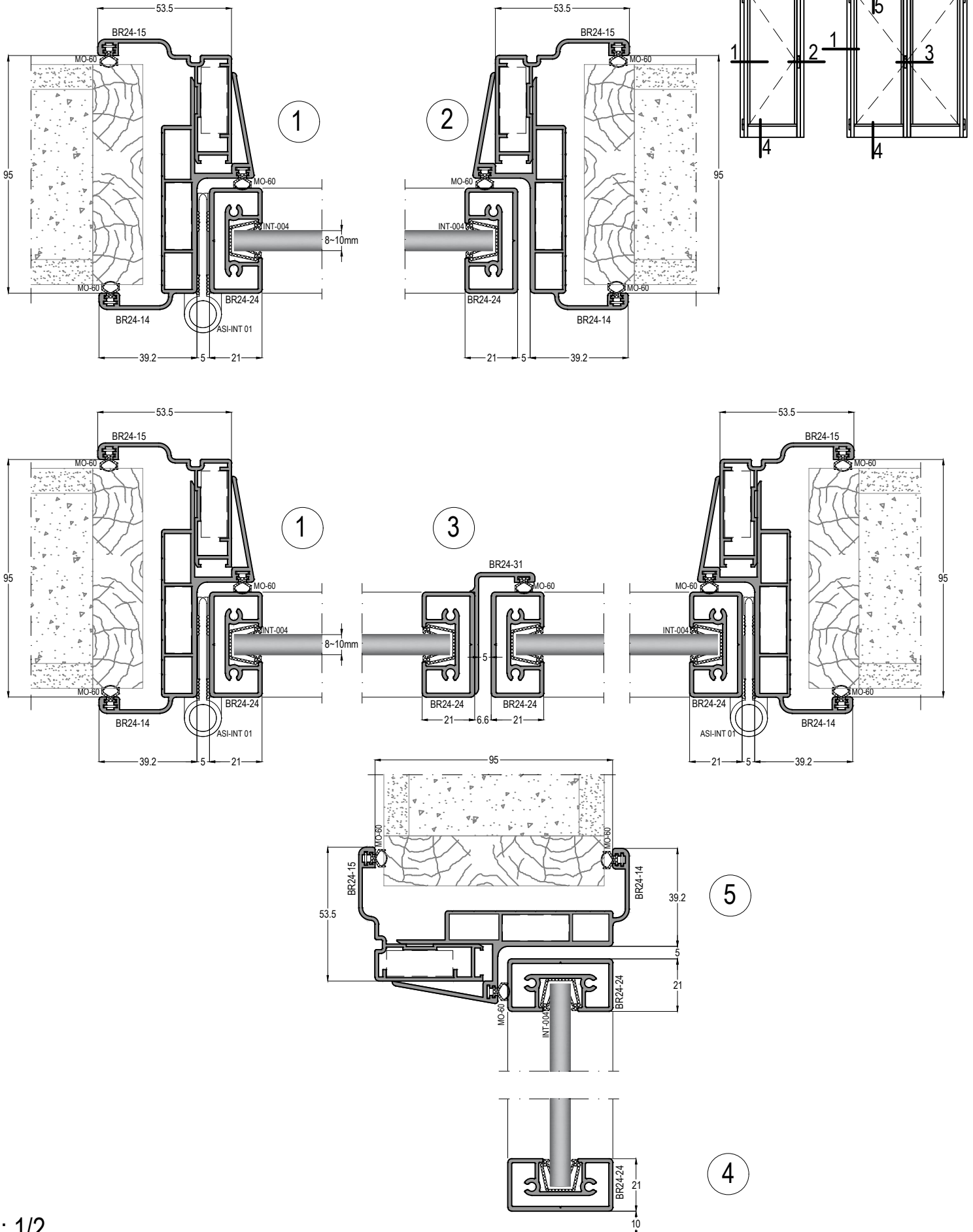

INTERNO KAPI - GENİŞ PERVAZLI SERİ INTERNO DOOR - WIDE SERIAL

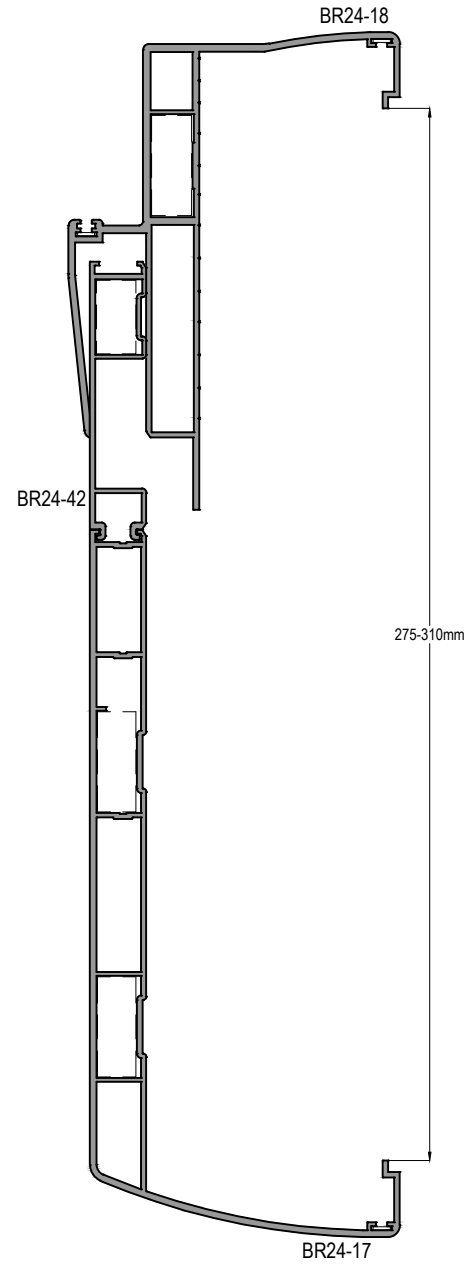
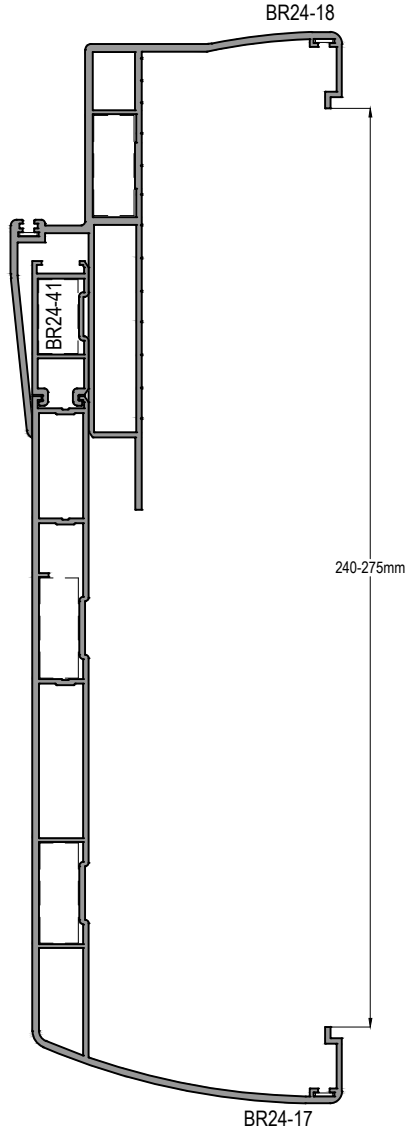
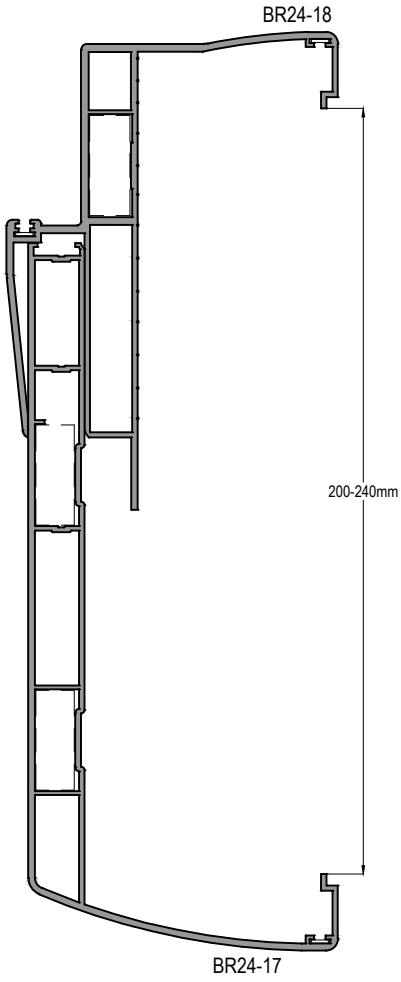

INTERNO KAPI - GENİŞ PERVAZLI SERİ INTERNO DOOR - WIDE SERIAL

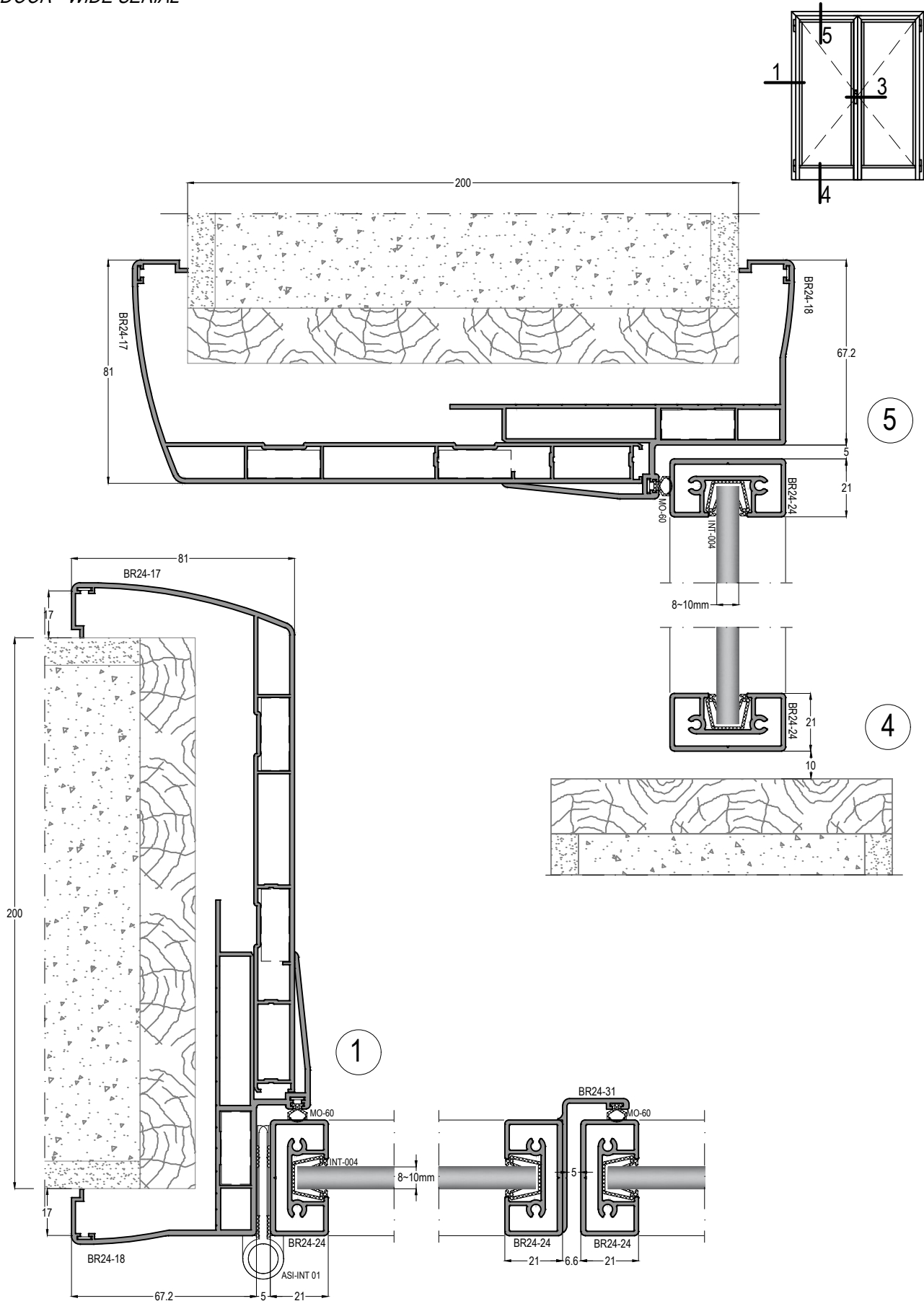

INTERNO KAPI - EKONOMİK PERVAZLI SERİ INTERNO DOOR - ECONOMIC SERIAL

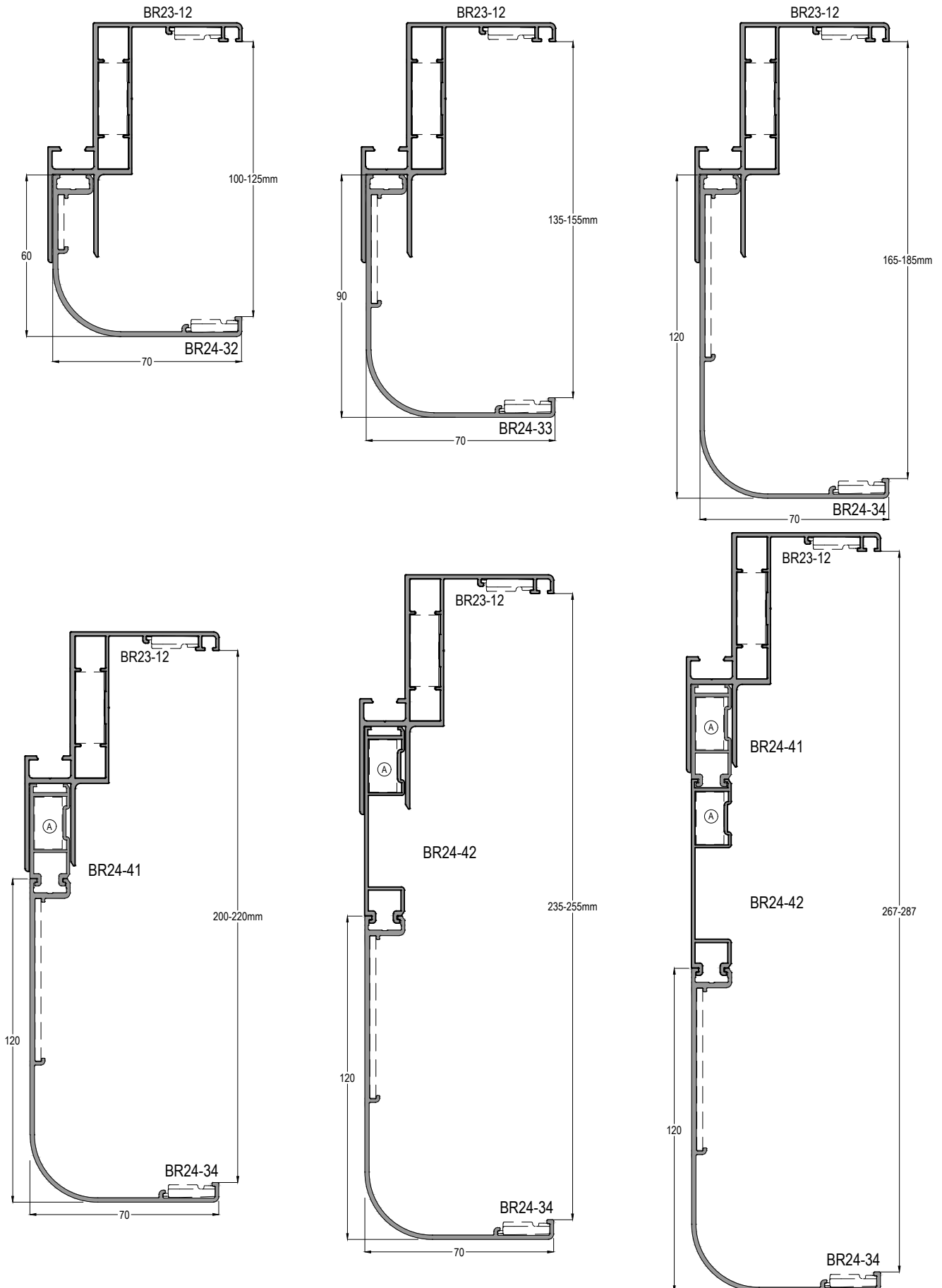

INTERNO KAPI

İÇ MEKAN KAPI SİSTEMİ
INDOOR DOOR SYSTEM



INTERNO KAPI - EKONOMİK PERVAZLI SERİ INTERNO DOOR - ECONOMIC SERIAL

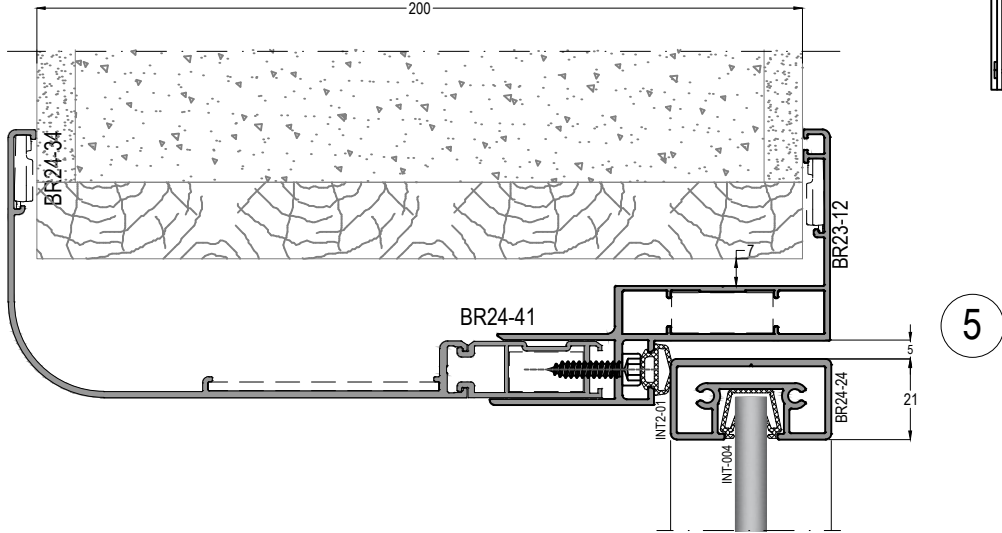
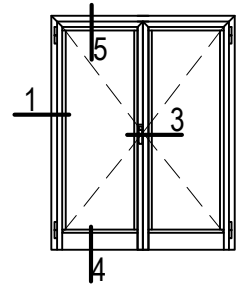

1

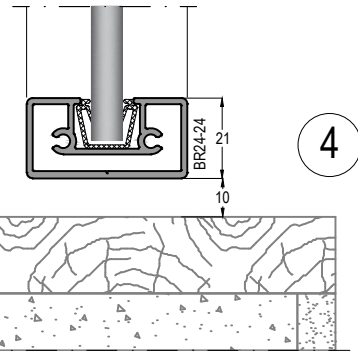
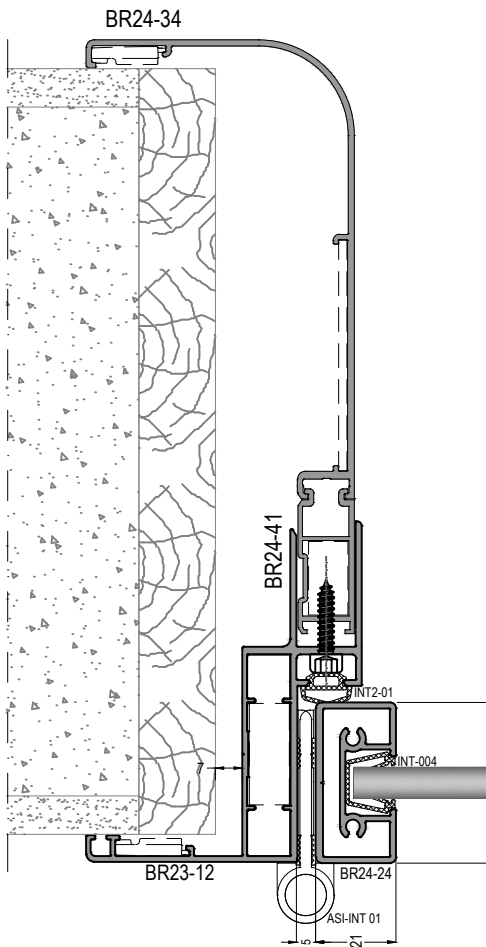

3

