











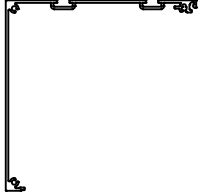
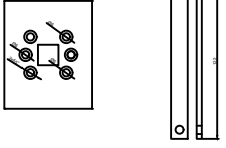

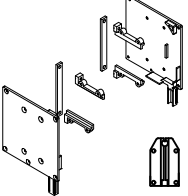
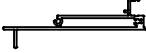

Z30

ZİP PERDE SİSTEMİ
ZIP CURTAIN SYSTEM



PROFİL LİSTESİ - PROFILES LIST

AKSESUAR LİSTESİ - ACCESSORIES LIST

1203			EMZ30-06		
ÜST KUTU PROFİLİ TOP BOX PROFILE	AĞIRLIK / Weight 2,175 kg/mt		LAMEL TUTUCU KAPAK TAKIMI COVER SET	AĞIRLIK / Weight Adet / Piece	
1204			EMZ30-01		
ÜST KUTU KAPAK PROFİLİ TOP BOX COVER PROFILE	AĞIRLIK / Weight 0,680 kg/mt		ÜST KUTU MOTOR KAPAK TAKIM-ALT TKMI MOTOR SIDE COVER	AĞIRLIK / Weight Takım/Set	
1207			EMZ30-03		
ÜST KUTU KAPAK PROFİLİ TOP BOX COVER PROFILE	AĞIRLIK / Weight 1,304 kg/mt		TÜP MOTOR 60RS 60NM+ALICI MOTOR	AĞIRLIK / Weight Adet / Piece	
1205			EMZ30-04-1		
KANAL PROFİLİ CHANEL PROFILE	AĞIRLIK / Weight 1,079 kg/mt		KUMANDA (Tek Kanallı) REMOTE CONTROL (Single Chanel)	AĞIRLIK / Weight Adet / Piece	
1206			EMZ30-04-2		
KANAL KAPAK PROFİLİ CHANEL COVER PROFILE	AĞIRLIK / Weight 0,480 kg/mt		KUMANDA (6 Kanallı) REMOTE CONTROL (6 Chanel)	AĞIRLIK / Weight Adet / Piece	
1208			EMZ30-05		
ETEK PROFİLİ BOTTOM PROFILE	AĞIRLIK / Weight 0,827 kg/mt		TAMBUR BAŞI MOTOR PROVISIONS	AĞIRLIK / Weight Adet / Piece	
01-000100-15			G100-A11-2		
BORU PROFİLİ Ø10 PIPE PROFILE	AĞIRLIK / Weight 0,111 kg/mt		PLASTİK RULMAN YATAĞI ROLLER SLOT	AĞIRLIK / Weight Adet / Piece	
Z30-A12			G100-A11-4		
GALVANİZ MOTOR BORU PROFİLİ HORIZONTAL MOTOR PROFILE	AĞIRLIK / Weight 6 mt / kg		RULMAN ROLLER	AĞIRLIK / Weight Adet / Piece	
			EMZ30-07		
			VİDA OTOMAT BAĞLANTI PVC CURTAIN WALL CONNECTIONS	AĞIRLIK / Weight 6 mt / kg	

Z30

ZIP PERDE SİSTEMİ
ZIP CURTAIN SYSTEM

ASISTAL

PROFİL DETAYLARI
PROFILE DETAILS

Z30

ZIP PERDE SİSTEMİ
ZIP CURTAIN SYSTEM

ASISTAL

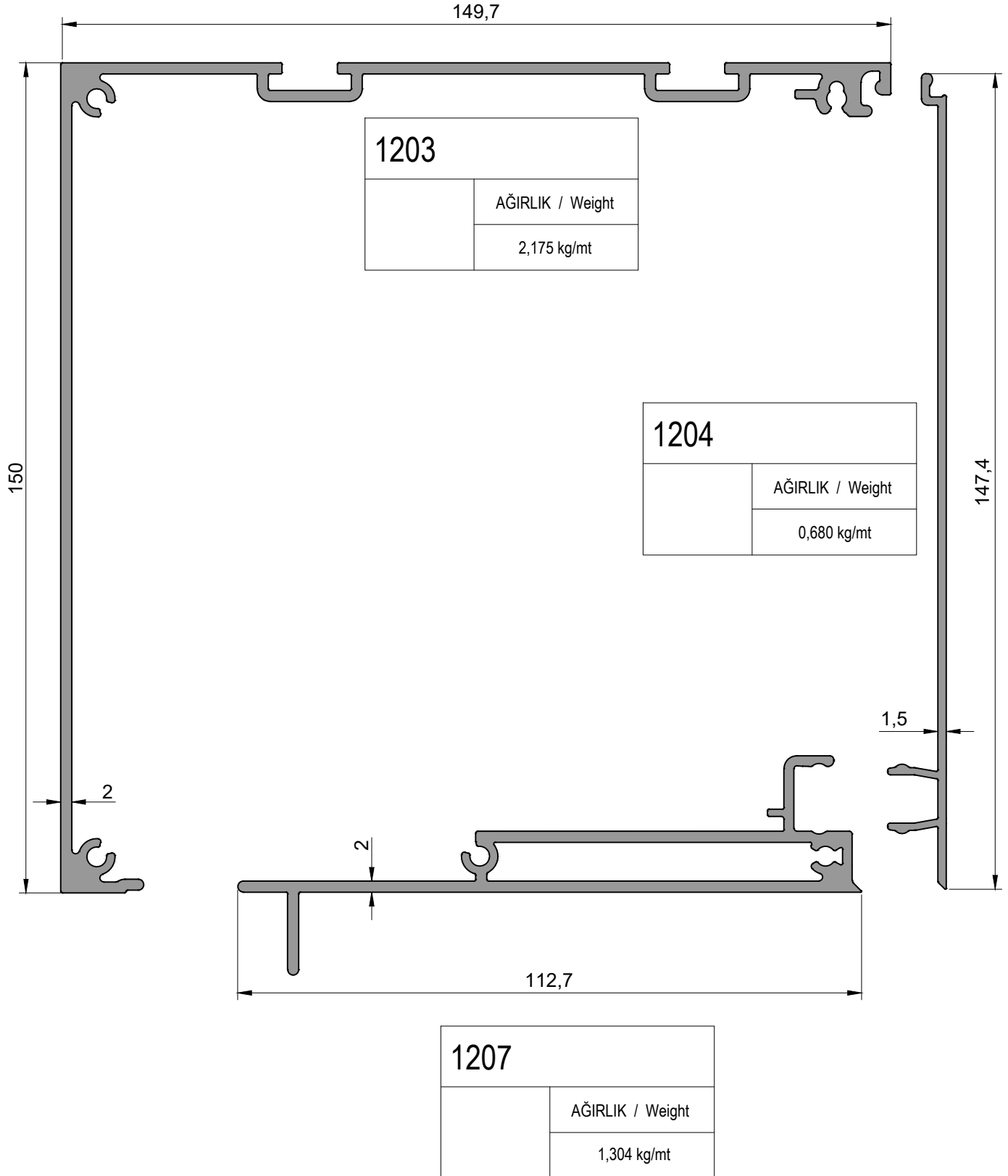

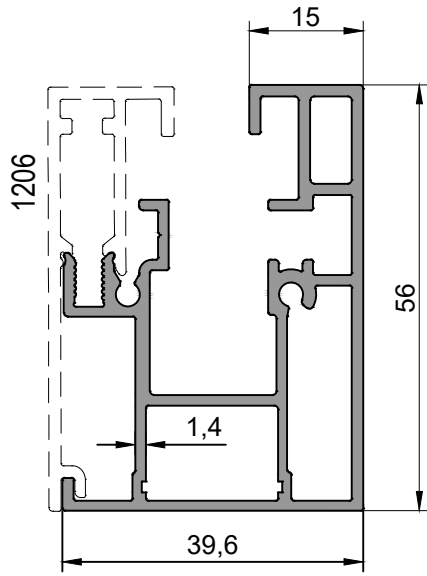

1205	
	AĞIRLIK / Weight
	1,079 kg/mt

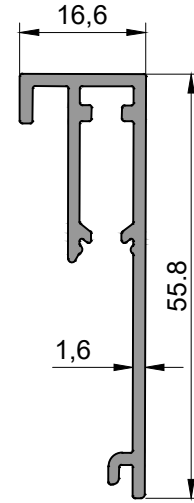

1206	
	AĞIRLIK / Weight
	0,480 kg/mt

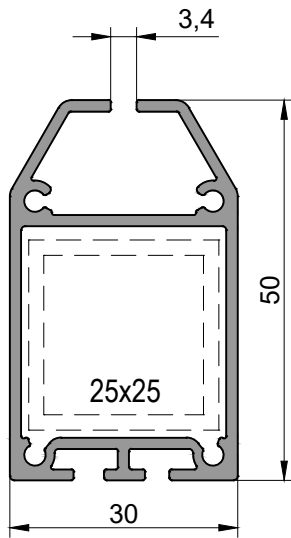

1208	
	AĞIRLIK / Weight
	0,827 kg/mt

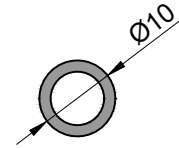

01-000100-15	
	AĞIRLIK / Weight
	0,111 kg/mt

Z30

ZIP PERDE SİSTEMİ
ZIP CURTAIN SYSTEM



SİSTEM DETAYLARI
SYSTEM DETAILS

Z30

ZIP PERDE SİSTEMİ
ZIP CURTAIN SYSTEM

ASISTAL

150

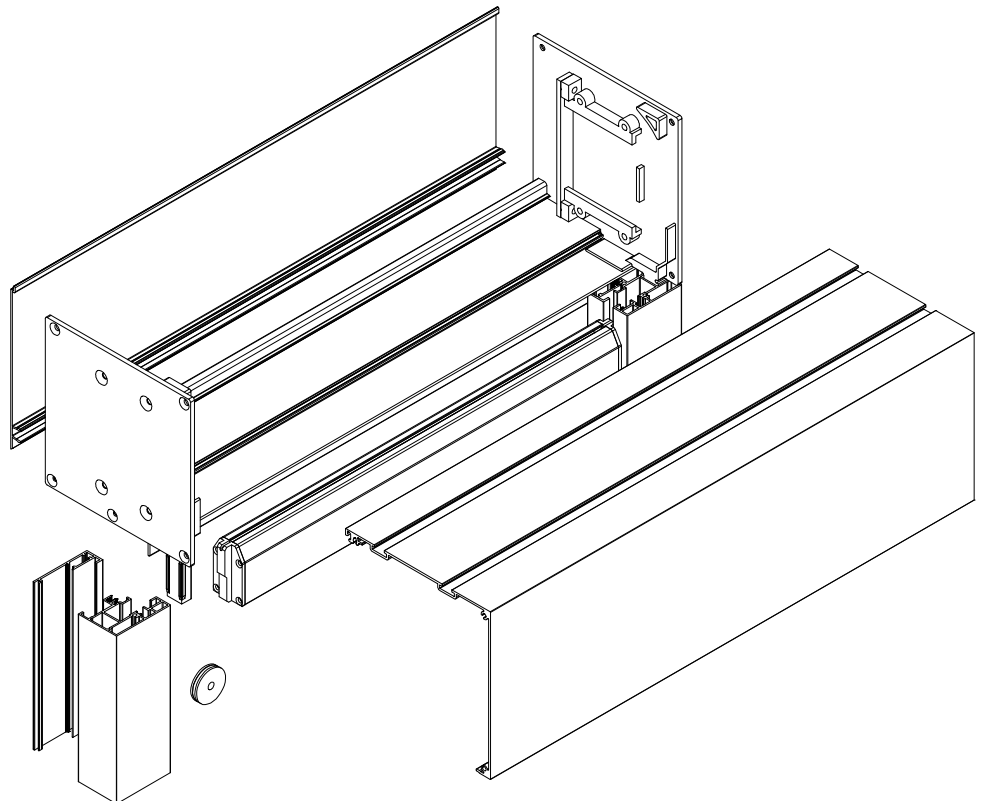
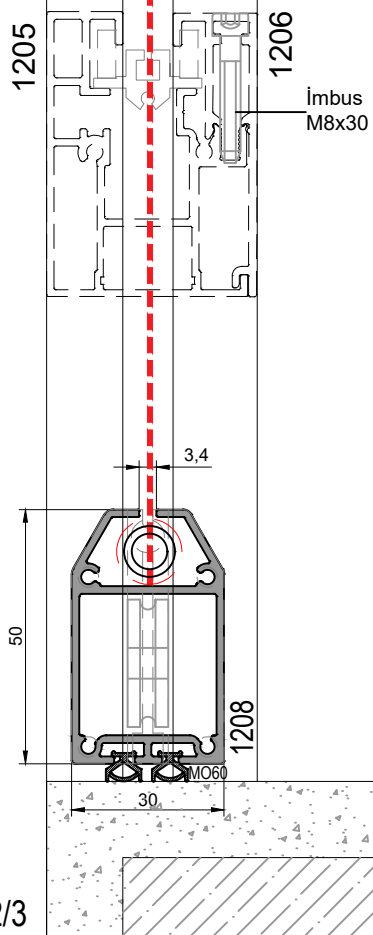
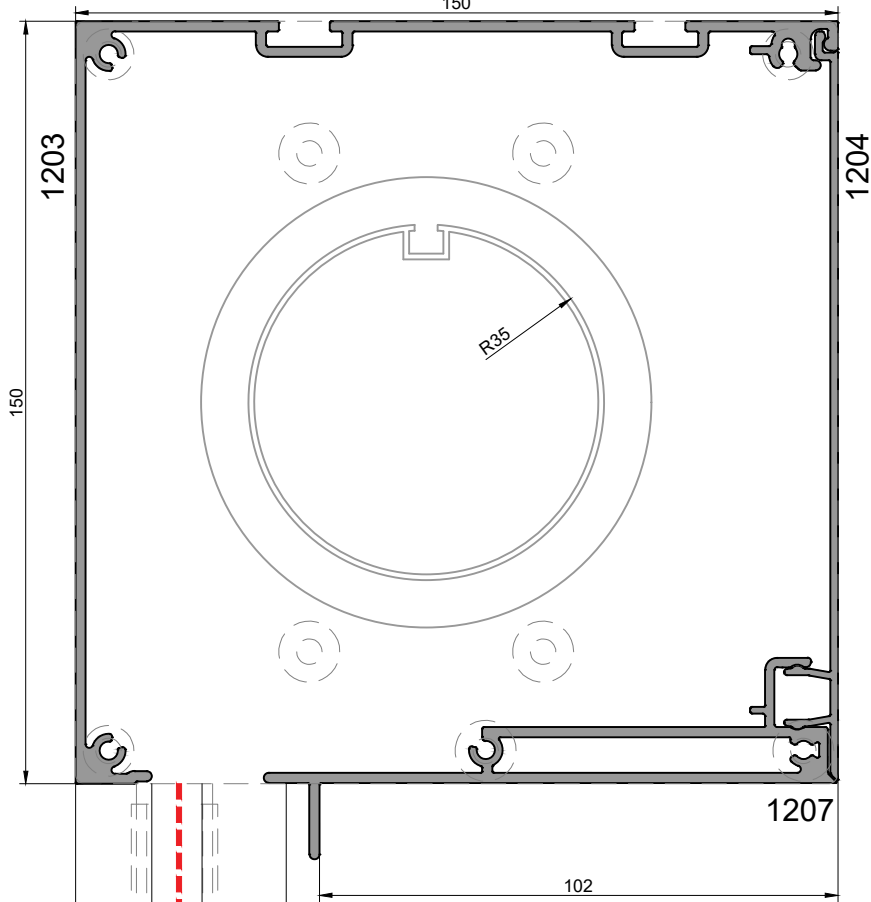

Z30

ZIP PERDE SİSTEMİ
ZIP CURTAIN SYSTEM

ASİSTAL

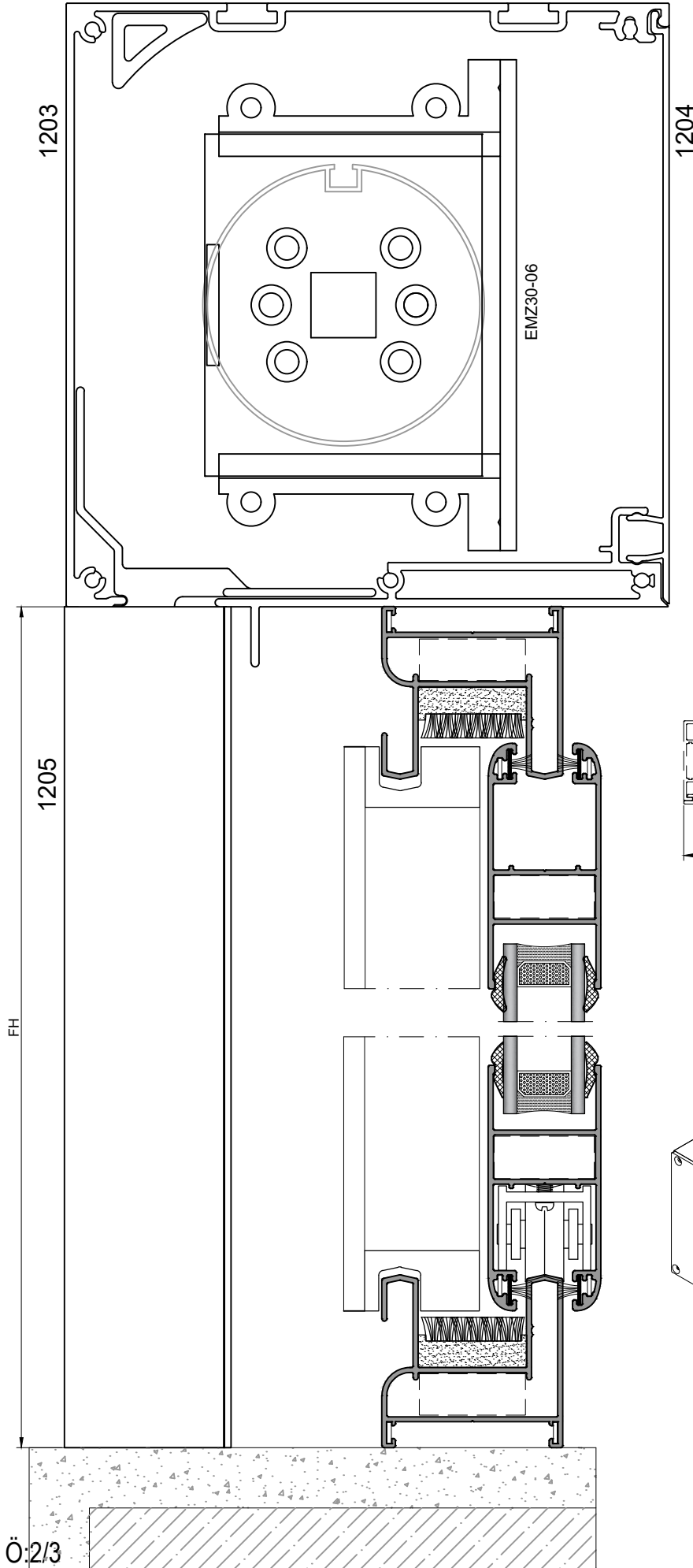

1 Takım için Z30 için Gerekli
Aksesuar Listesi
Required Accessories List for
Z30 for 1 Set

AKASESUAR KODU Accessories Code	ADET Piece
Z30-A12	FW-110mm
EMZ30-01	TK./SET
EMZ30-06	TK./SET
EMZ30-03	TK./SET
EMZ30-04-1	ADT./PIECE
EMZ30-05	ADT./PIECE
G100-A11-2	ADT./PIECE
G100-A11-4	ADT./PIECE
EMZ30-07	6mt.

