

WTD95

HEMYÜZ KAPI SİSTEMİ
FLAT DOOR SYSTEM

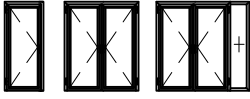

İÇE AÇILIR CAMLI KAPI
INWARD OPENING WITH GLAZING
DIŞA AÇILIR CAMLI KAPI
OUTWARD OPENING WITH GLAZING

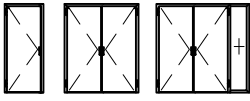

İÇE AÇILIR PANEL KAPI
INWARD OPENING WITH PANEL DOOR
DIŞA AÇILIR PANEL KAPI
OUTWARD OPENING WITH PANEL DOOR

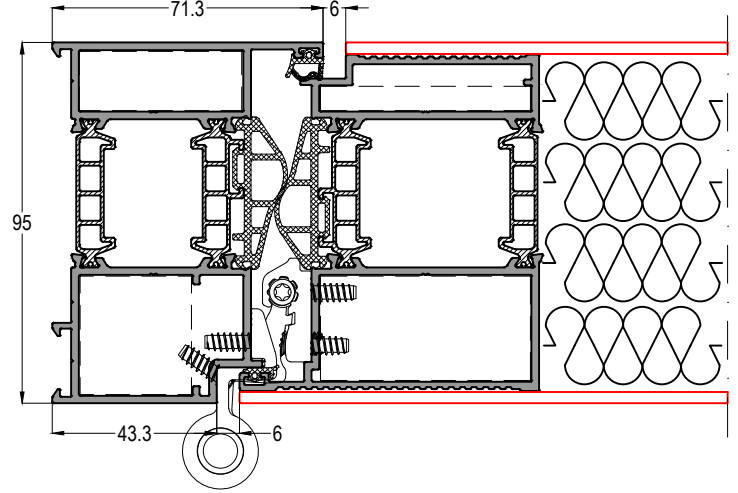



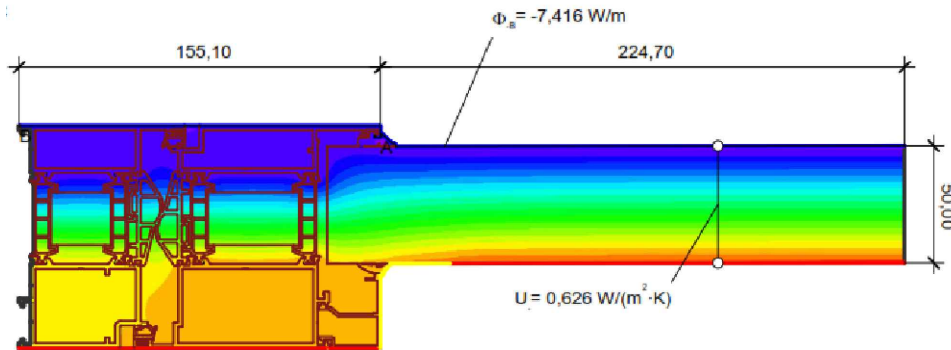

KASA GENİŞLİĞİ	: 95 mm
Frame width	
KANAT DERİNLİĞİ	: 95 mm
Sash depth	
SİSTEM ET KALINLIĞI	: 2 mm
System wall tickness	
ISI BARIYERİ	: 39 mm
Insulation barrier	
CAM KALINLIĞI	: 38 - 64 mm
Glass thickness	

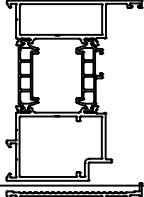

$$U_{TAB} = \frac{\frac{\Phi}{\Delta T} - U_p \cdot b_p}{b_i} = \frac{\frac{7,416}{20,000} - 0,626 \cdot 0,225}{0,155} = 1,48 \text{ W/(m}^2 \cdot \text{K)}$$

PROFİL VE AKSESUAR LİSTELERİ
PROFILE & ACCESSORIES LISTS

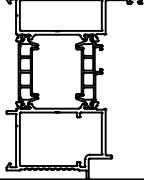

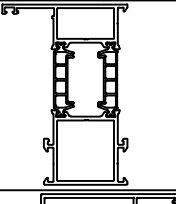
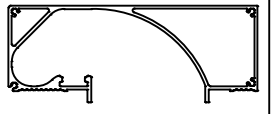
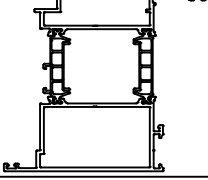
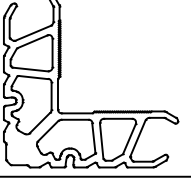
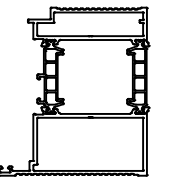
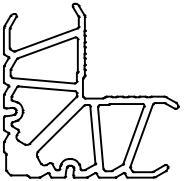
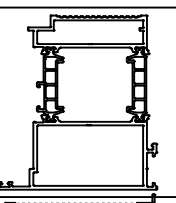
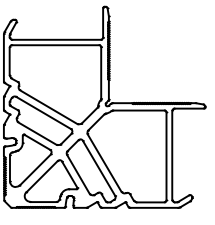
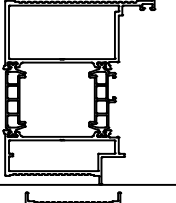
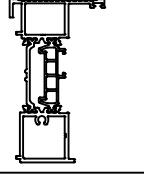
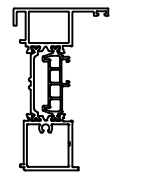
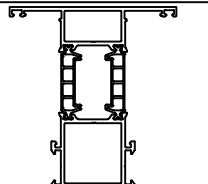







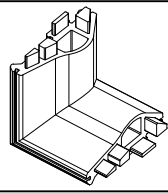

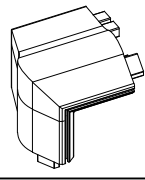

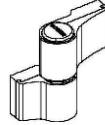

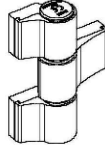
PROFİL LİSTESİ - PROFILES LIST

WTD95 01			WTD95 A01		
KASA PROFİLİ FRAME PROFILE	AĞIRLIK / Weight 2,258 kg/mt		ADAPTÖR PROFİLİ ADAPTER PROFILE	AĞIRLIK / Weight 0,247 kg/mt	
WTD95 03			WTD95 02		
KASA PROFİLİ FRAME PROFILE	AĞIRLIK / Weight 2,213 kg/mt		EŞİK PROFİLİ BOTTOM RAIL PROFILE	AĞIRLIK / Weight 0,985 kg/mt	
WTD95 20			DH-01		
KASA PROFİLİ FRAME PROFILE	AĞIRLIK / Weight 2,057 kg/mt		KOL PROFİLİ HANDLE PROFILE	AĞIRLIK / Weight 2,084 kg/mt	
WTD95 10			10-010294-00		
İÇE AÇILIR KAPI KANAT PROFİLİ SASH PROFILE FOR INNER OPENING	AĞIRLIK / Weight 2,670 kg/mt		KÖŞE TAKOZU-29,4 mm CORNER JOINT	AĞIRLIK / Weight 4,806 kg/mt	
WTD95 11 (Siyah Mat Eloksal)			10-010429-00		
İÇE AÇILIR KAPI KANAT PROFİLİ SASH PROFILE FOR INNER OPENING	AĞIRLIK / Weight 2,326 kg/mt		KÖŞE TAKOZU-42,7 mm CORNER JOINT	AĞIRLIK / Weight 5,482 kg/mt	
WTD95 12			10-010553-00		
İÇE AÇILIR KAPI KANAT PROFİLİ SASH PROFILE FOR INNER OPENING	AĞIRLIK / Weight 2,445 kg/mt		KÖŞE TAKOZU-55,3 mm CORNER JOINT	AĞIRLIK / Weight 6,251 kg/mt	
WTD95 13					
İÇE AÇILIR KAPI KANAT PROFİLİ SASH PROFILE FOR INNER OPENING	AĞIRLIK / Weight 2,389 kg/mt				
WTD95 41					
ADAPTÖR PROFİLİ ADAPTER PROFILE	AĞIRLIK / Weight 1,596 kg/mt				
WTD95 42					
ADAPTÖR PROFİLİ ADAPTER PROFILE	AĞIRLIK / Weight 1,585 kg/mt				
WTD95 21					
ORTA KAYIT PROFİLİ MULLION-TRANSOM PROFILE	AĞIRLIK / Weight 2,192 kg/mt				

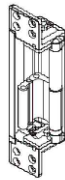
Profil ağırlıklarımız teorik olup; teslim anındaki tartımız geçerlidir.

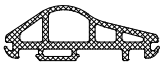

Profile weights are theoretical and the weight at the time of delivery is valid.

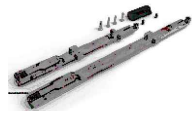
AKSESUAR LİSTESİ - ACCESSORIES LIST

EP1-01			EP95-V01		
DIŞ CAM FİTİLİ - 3,5 mm OUTER GLAZING GASKET	KOLİ MİKTARI/Package 240 mt / 15 kg		KASA VULKANİZE FİTİL FRAME CENTRAL CORNER GASKET	KOLİ MİKTARI/Package Adet / Piece	
KC 02			EP95-V02		
CAM FİTİLİ - 2 mm GLAZING GASKET	KOLİ MİKTARI/Package 100 mt / 4,5 kg		KANAT VULKANİZE FİTİL SASH CENTRAL CORNER GASKET	KOLİ MİKTARI/Package Adet / Piece	
EP2-01			EP95-H01		
İÇ CAM FİTİLİ - 3 mm INNER GLAZING GASKET	KOLİ MİKTARI/Package 440 mt / 15 kg		YÜZEYSEL 2'Lİ MENTEŞE SURFACE HINGE	KOLİ MİKTARI/Package Adet / Piece	
EP2-02			EP95-H02		
İÇ CAM FİTİLİ - 4 mm INNER GLAZING GASKET	KOLİ MİKTARI/Package 300 mt / 15 kg		YÜZEYSEL 3'Lİ MENTEŞE SURFACE HINGE	KOLİ MİKTARI/Package Adet / Piece	
EP2-03			EP95-H03		
İÇ CAM FİTİLİ - 5 mm INNER GLAZING GASKET	KOLİ MİKTARI/Package 250 mt / 15 kg		SİSTEM MENTEŞE ROLLER HINGE	KOLİ MİKTARI/Package Adet / Piece	
KC 06			EP95-H04		
CAM FİTİLİ - 6 mm GLAZING GASKET	KOLİ MİKTARI/Package 100 mt / 8 kg		GİZLİ MENTEŞE CONCEALED HINGE	KOLİ MİKTARI/Package Adet / Piece	
EPW3-01			ASI-LS M2200		
KANAT BİNİ FİTİLİ SASH GASKET	KOLİ MİKTARI/Package 625 mt / 15 kg		ÇOK NOKTADAN KİLİTLEME (h: 1900mm-2300mm) MULTIPOINT LOCK	KOLİ MİKTARI/Package Adet / Piece	
EPW3-02			ASI-LS K2201-A		
KASA BİNİ FİTİLİ-COEX FRAME GASKET	KOLİ MİKTARI/Package 275 mt / 11,3 kg		KİLİT KARŞILIK SET - SAĞ LOCK COUNTERPLATE - RIGHT	KOLİ MİKTARI/Package Takım / Set	
EP95-01			ASI-LS K2201-B		
ORTA BİNİ FİTİLİ CENTRAL GASKET	KOLİ MİKTARI/Package 40 mt / 10,2 kg		KİLİT KARŞILIK SET - SOL LOCK COUNTERPLATE - LEFT	KOLİ MİKTARI/Package Takım / Set	
EP95-02			ASI-LS K2203		
EŞİK FİTİLİ GASKET FOR TRHESHOLD	KOLİ MİKTARI/Package 340 mt / 15 kg		PASİF KANAT SÜRGÜ TAKIMI DOUBLE DOOR LEAF FIXING SET	KOLİ MİKTARI/Package Takım / Set	

* Doğru kilitleme seçilebilmesi için siparişlerinizde kapı kanat yüksekliği mutlaka belirtilmeli
Door Sash height must be given in your order, to choose the correct locking.

AKSESUAR LİSTESİ - ACCESSORIES LIST

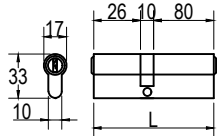
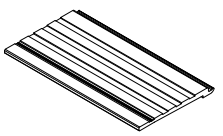
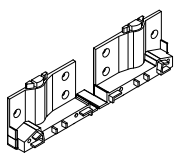
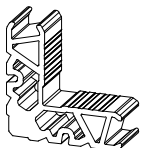
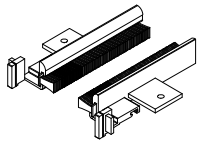
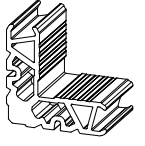
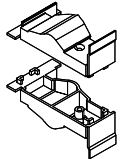
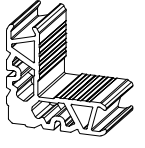
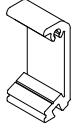
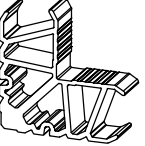
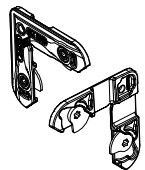
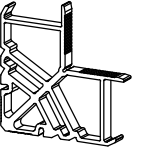
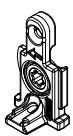
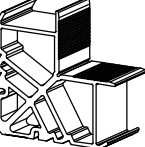
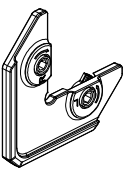
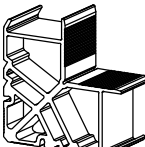
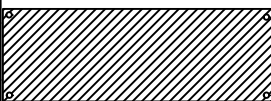
ASI-DH 002			DH-01 LED		
KAPI KOLU DOOR HANDLE	KOLİ MİKTARI/Package Adet / Piece		ŞEFFAF LED KAPAĞI LED LIGHT COVER	KOLİ MİKTARI/Package mt / mt	
ASI-BRL 116			77-G100		
116 LİK BAREL CYLINDER 116	KOLİ MİKTARI/Package Adet / Piece		CAM TAKOZU GLAZING SUPPORT	KOLİ MİKTARI/Package Adet / Piece	
WTD95-PL01			ASI-KT 3015		
PVC EŞİK KAPAK PVC THRESHOLD COVER	KOLİ MİKTARI/Package Adet / Piece		KÖŞE TAKOZU PRESS CORNER JOINT	KOLİ MİKTARI/Package Adet / Piece	
WTD95-PL02			ASI-KT 3028		
PVC KANAT KAPAK PVC SASH COVER	KOLİ MİKTARI/Package Adet / Piece		KÖŞE TAKOZU PRESS CORNER JOINT	KOLİ MİKTARI/Package Adet / Piece	
WTD95-HOK			ASI-KT 3031		
PVC ADAPTÖR KAPAK PVC ADAPTER COVER	KOLİ MİKTARI/Package Takım / Set		KÖŞE TAKOZU PRESS CORNER JOINT	KOLİ MİKTARI/Package Adet / Piece	
ASI-DB 9129			ASI-KT 4316		
DİK BAĞLANTI T JOINT	KOLİ MİKTARI/Package Adet / Piece		KÖŞE TAKOZU PRESS CORNER JOINT	KOLİ MİKTARI/Package Adet / Piece	
ASI-FUJI 2500			ASI-KT 5506		
AYARLI ORTA KAYIT BAĞLANTI T JOINT CONNECTION	KOLİ MİKTARI/Package Adet / Piece		KÖŞE TAKOZU PRESS CORNER JOINT	KOLİ MİKTARI/Package Adet / Piece	
ASI-FUJI 2700			ASI-KT 5528		
AYARLI ORTA KAYIT BAĞLANTI T JOINT CONNECTION	KOLİ MİKTARI/Package Adet / Piece		KÖŞE TAKOZU PRESS CORNER JOINT	KOLİ MİKTARI/Package Adet / Piece	
ASI-FUJI 2000			ASI-KT 5531		
AYARLI KÖŞE GÖNYESİ CORNER ALIGNMENT	KOLİ MİKTARI/Package Adet / Piece		KÖŞE TAKOZU PRESS CORNER JOINT	KOLİ MİKTARI/Package Adet / Piece	
ASI-CAP DH01					
ALÜMİNYUM KAPAK (profil renginde boyanacak) COVER (RAL powder)	KOLİ MİKTARI/Package Adet / Piece				

* Doğru kilitleme seçilebilmesi için siparişlerinizde kapı kanat yüksekliği mutlaka belirtilmeli
Door Sash height must be given in your order, to choose the correct locking.

WTD95 - 2 mm

HEMYÜZ KAPI SİSTEMİ
FLAT DOOR SYSTEM

ASISTAL

PROFİL DETAYLARI
PROFILE DETAILS



WTD95 - 2 mm

HEMÜZ KAPI SİSTEMİ
FLAT DOOR SYSTEM

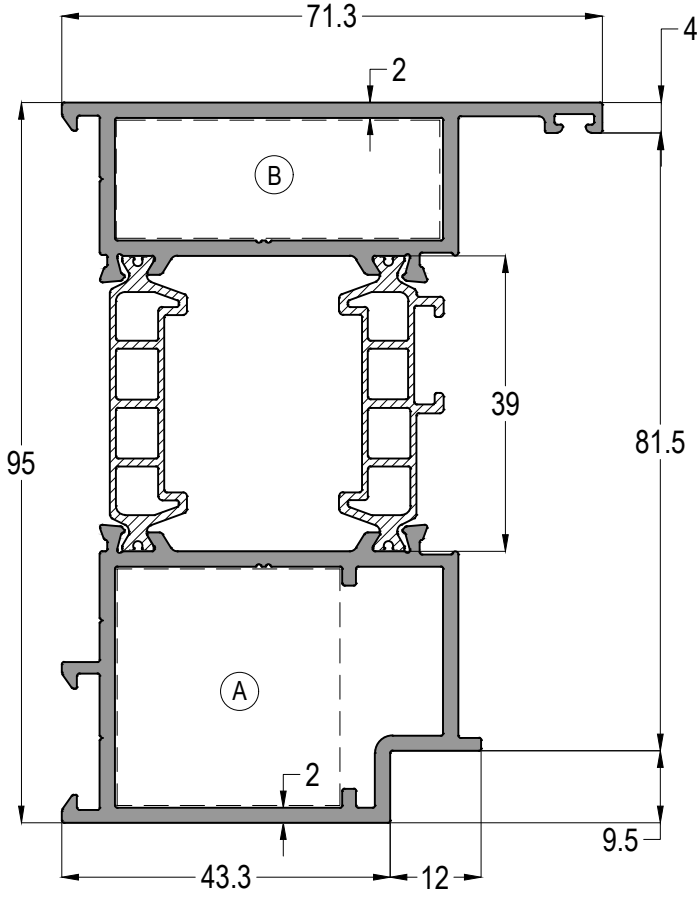
ASISTAL



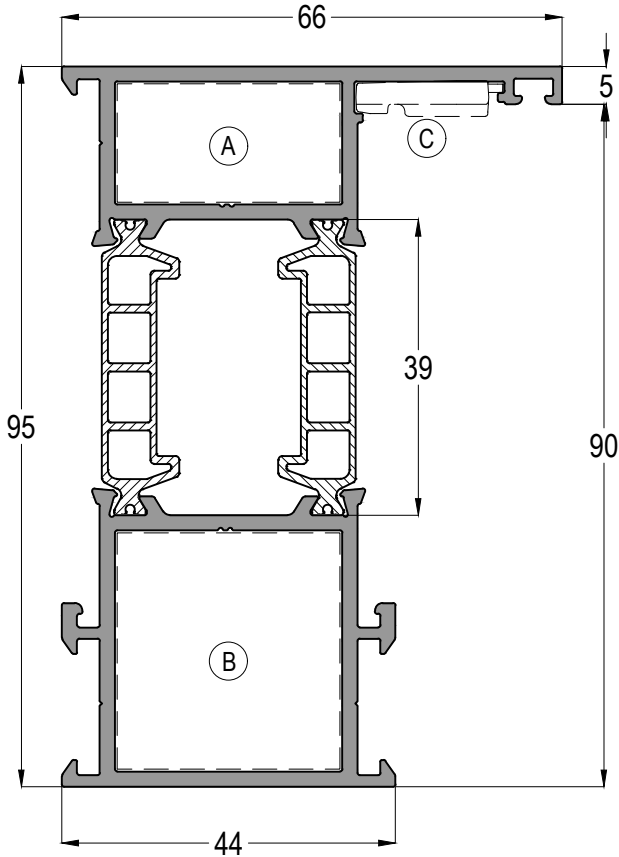

WTD95 01

A	B	AĞIRLIK / Weight
 ASI-KT 3031	 ASI-KT 4316	2,258 kg/mt



WTD95 20

A	B	C	AĞIRLIK / Weight
 ASI-KT 3015	 ASI-KT 3031	 ASI-FUJI 2000	2,057 kg/mt



WTD95 - 2 mm

HEMYÜZ KAPI SİSTEMİ
FLAT DOOR SYSTEM

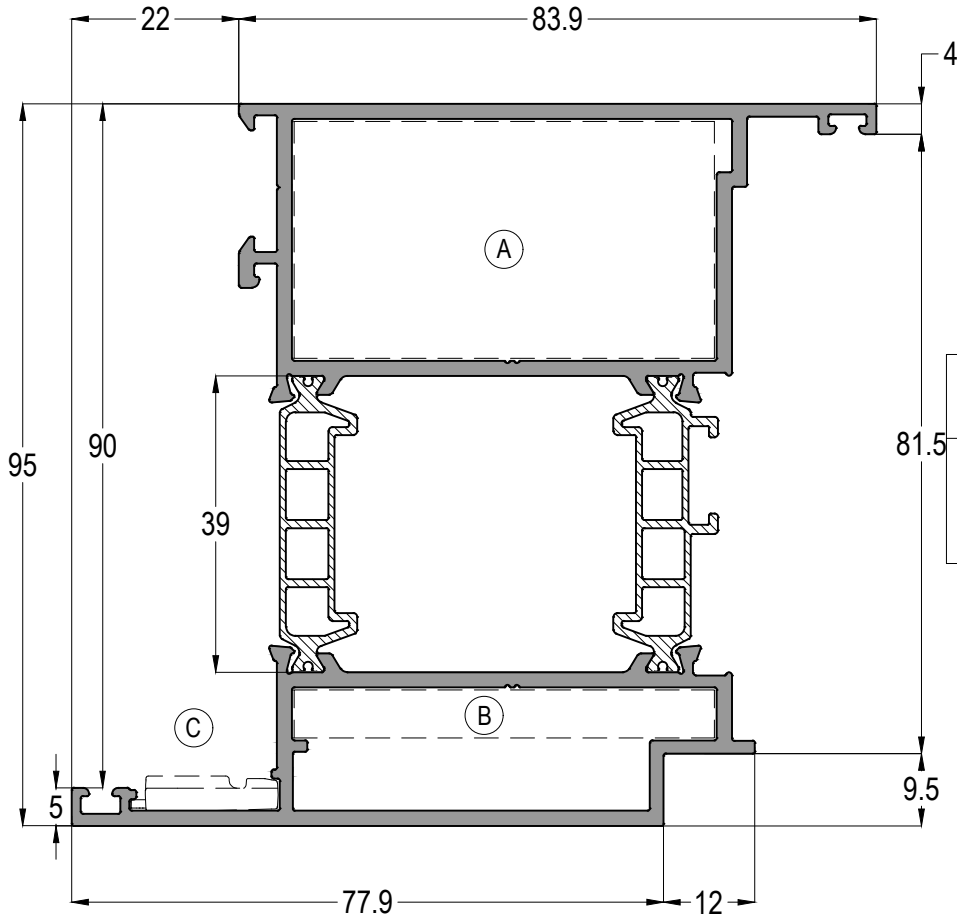
ASISTAL



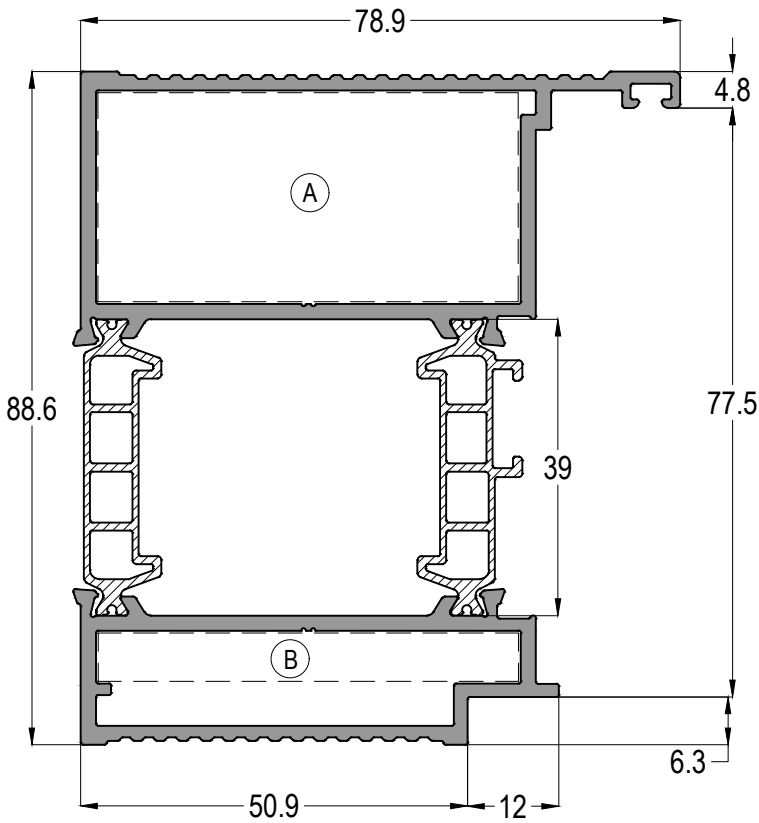

WTD95 10

 ASI-KT 5531	 ASI-KT 5506	 ASI-FUJI 2000	AĞIRLIK / Weight 2,670 kg/mt
--	--	--	---------------------------------



WTD95 11

 ASI-KT 5528	 ASI-KT 5506	AĞIRLIK / Weight 2,326 kg/mt
---	--	---------------------------------

WTD95 - 2 mm

HEMÜZ KAPI SİSTEMİ
FLAT DOOR SYSTEM

ASISTAL

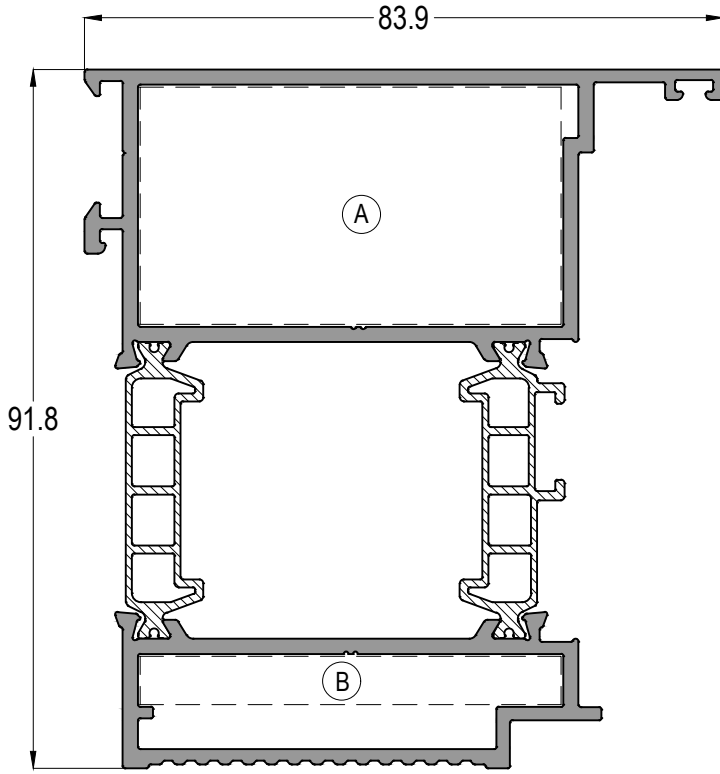

WTD95 12



ASI-KT 5531



ASI-KT 5506

AĞIRLIK / Weight

2,445 kg/mt

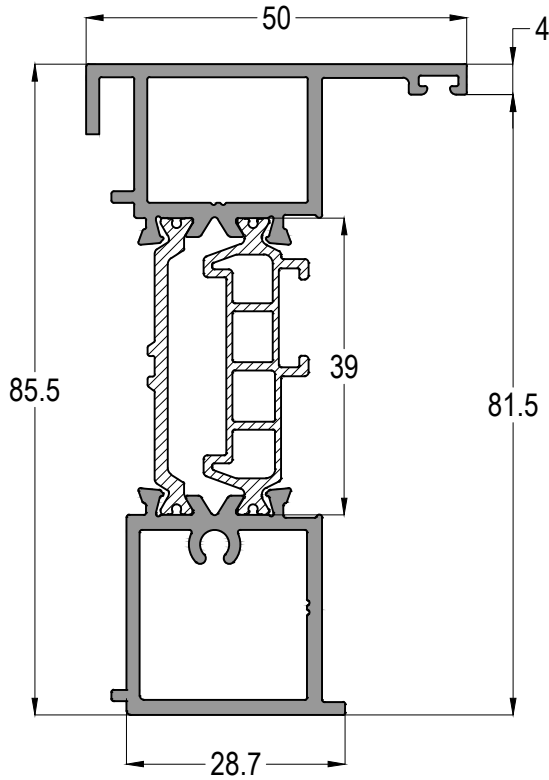

WTD95 42

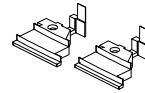

WTD95 HOK

AĞIRLIK / Weight

1,585 kg/mt

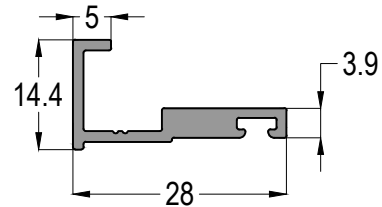

WTD95 A01

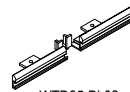

WTD95-PL02

AĞIRLIK / Weight

0,247 kg/mt

WTD95 - 2 mm

HEMÜZ KAPI SİSTEMİ
FLAT DOOR SYSTEM

ASISTAL

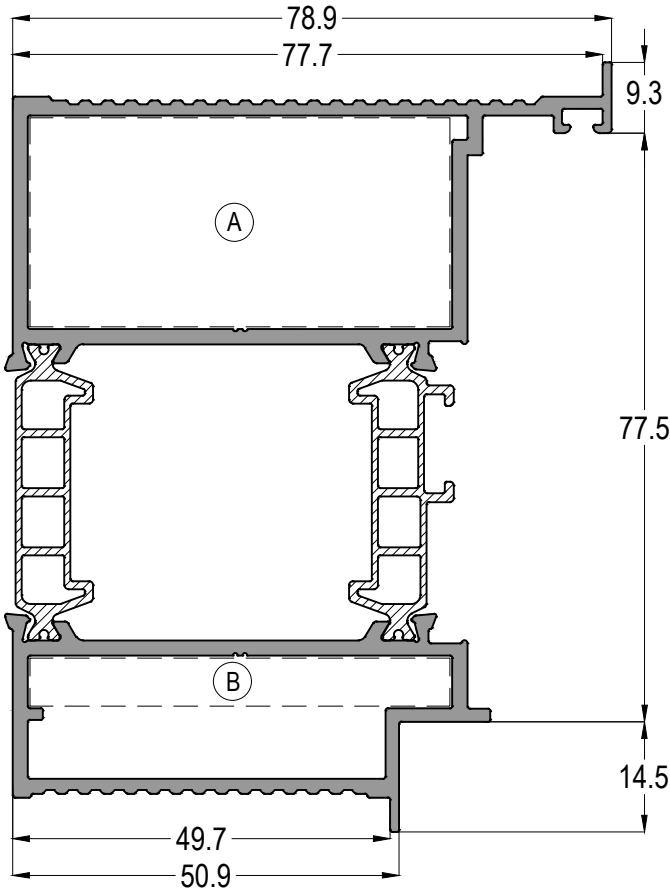

WTD95 13



AĞIRLIK / Weight

2,389 kg/mt

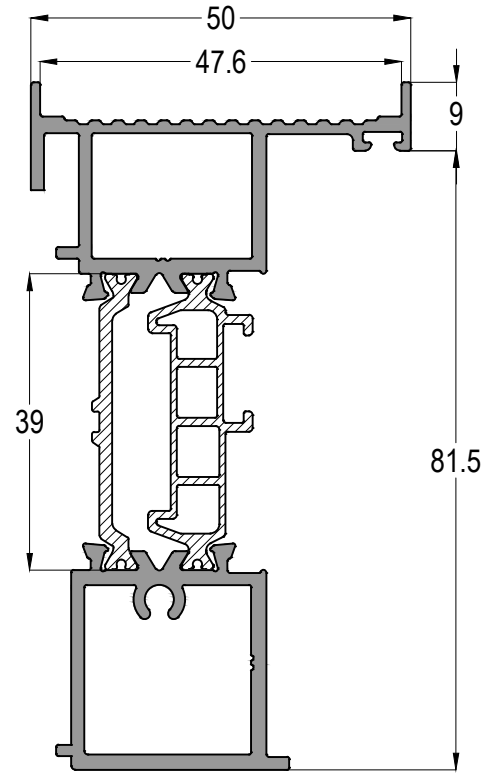

WTD95 41

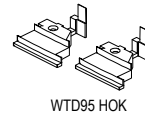

AĞIRLIK / Weight

1,596 kg/mt

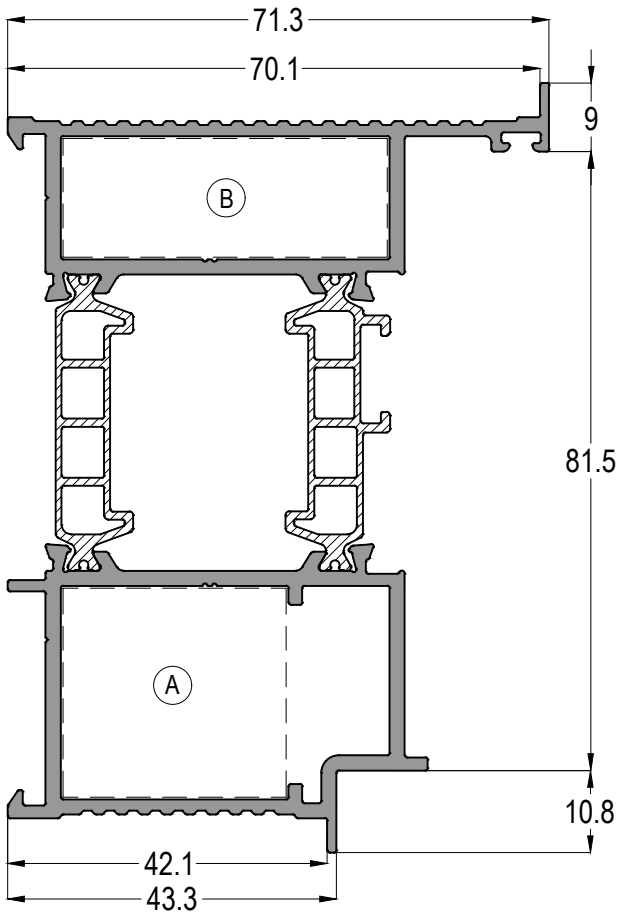

WTD95 03



AĞIRLIK / Weight

2,258 kg/mt

WTD95 - 2 mm

HEMYÜZ KAPI SİSTEMİ
FLAT DOOR SYSTEM

ASISTAL

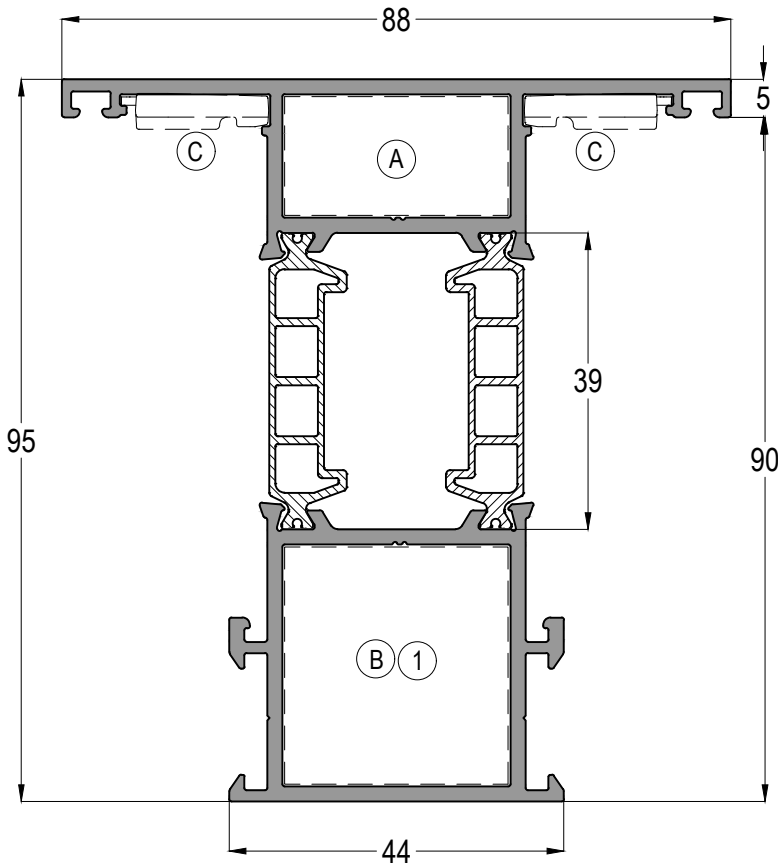

WTD95 21

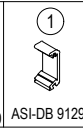

AĞIRLIK / Weight

2,192 kg/mt

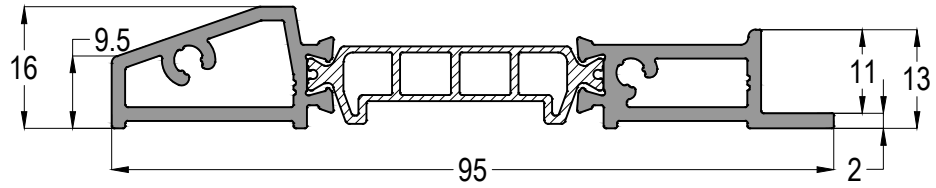

WTD95 02

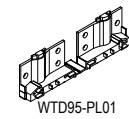

AĞIRLIK / Weight

0,985 kg/mt

DH-01

AĞIRLIK / Weight

2,084 kg/mt

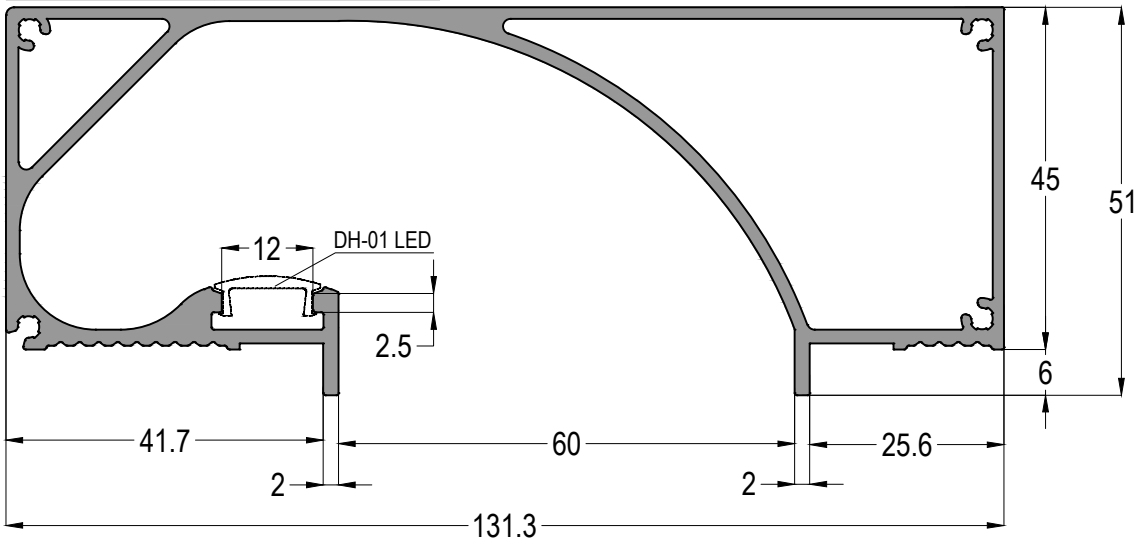

Profil ağırlıklarımız teorik olup; teslim anındaki tartımız geçerlidir.
Profile weights are theoretical and the weight at the time of delivery is valid.

WTD95 10 NOLU KANAT İÇİN CAM ÇITASI SEÇİMİ GLAZING BEAD FOR WTD95 10 PROFILE

11-020

0,276 kg/mt

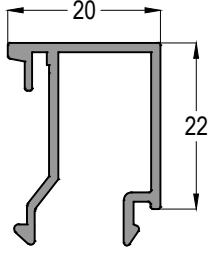

11-022

0,282 kg/mt

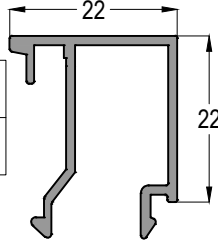

11-026

0,296 kg/mt

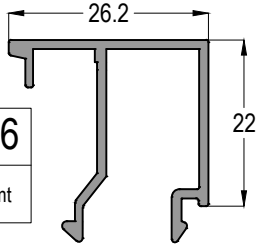

11-028

0,302 kg/mt

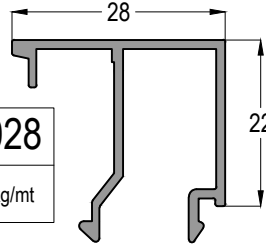

11-030

0,308 kg/mt

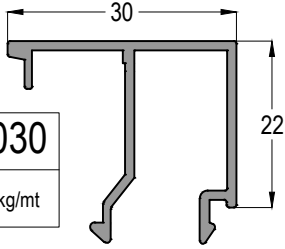

11-032

0,315 kg/mt

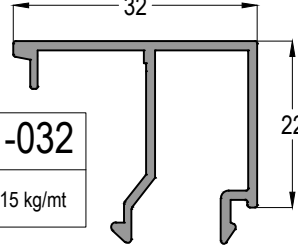

11-035

0,323 kg/mt

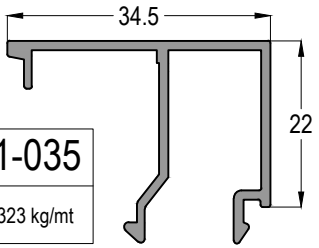

11-038

0,334 kg/mt

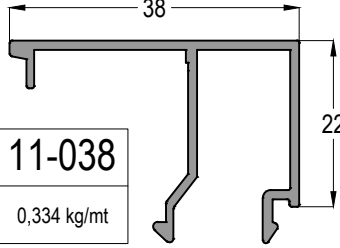

11-044

0,338 kg/mt

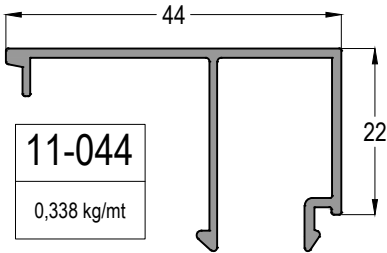

CAM KALINLIĞINA GÖRE CAM ÇITASI SEÇİM TABLOSU

Glazing Bead Selection Table according to the Glass Thickness

CAM KALINLIĞI Glass Thickness (mm)	CAM ÇITASI Glazing Bead	İÇ CAM FİTİLİ Glass Gasket (IN)	DIŞ CAM FİTİLİ Glass Gasket (OUT)
38	11-044	EP2-03	EP1-01
39	11-044	EP2-02	EP1-01
40	11-044	EP2-01	EP1-01
42	11-038	KC-06	EP1-01
43	11-038	KC-06	EP1-01
44	11-038	EP2-03	EP1-01
45	11-038	EP2-02	EP1-01
46	11-038	EP2-01	EP1-01
47	11-035	EP2-03	EP1-01
48	11-035	EP2-02	EP1-01
49	11-035	EP2-01	EP1-01
50	11-032	EP2-02	EP1-01
51	11-032	EP2-01	EP1-01
52	11-030	EP2-02	EP1-01
53	11-030	EP2-01	EP1-01
54	11-028	EP2-02	EP1-01
55	11-028	EP2-01	EP1-01
56	11-026	EP2-02	EP1-01
57	11-026	EP2-01	EP1-01
60	11-022	EP2-03	EP1-01
61	11-022	EP2-02	EP1-01
62	11-022	EP2-01	EP1-01
63	11-020	EP2-02	EP1-01
64	11-020	EP2-01	EP1-01

WTD95 - 2 mm

HEMYÜZ KAPI SİSTEMİ
FLAT DOOR SYSTEM

ASISTAL

SİSTEM DETAYLARI
SİSTEM DETAILS



İÇE AÇILIR KAPI DETAYLARI INNER OPENING DOOR DETAILS

6

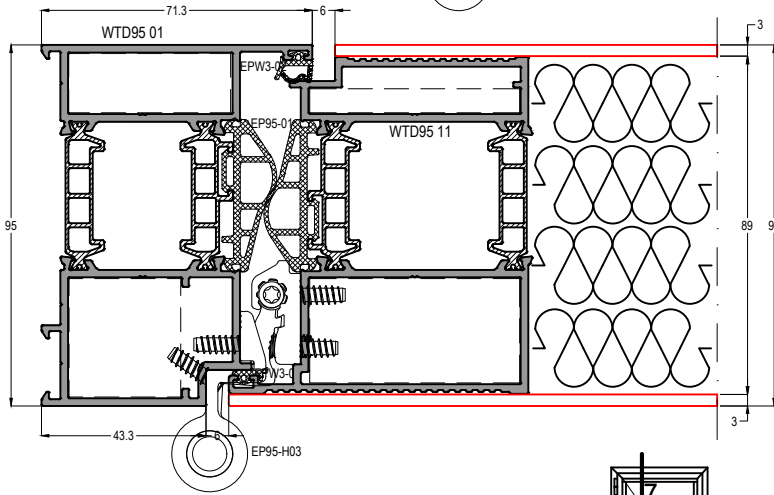

9

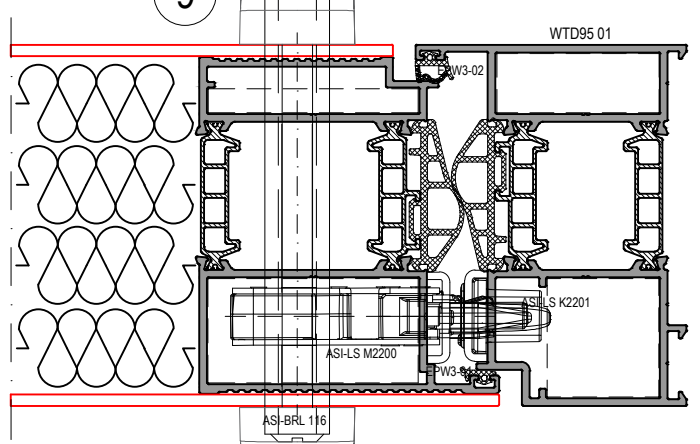

7

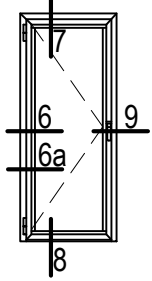
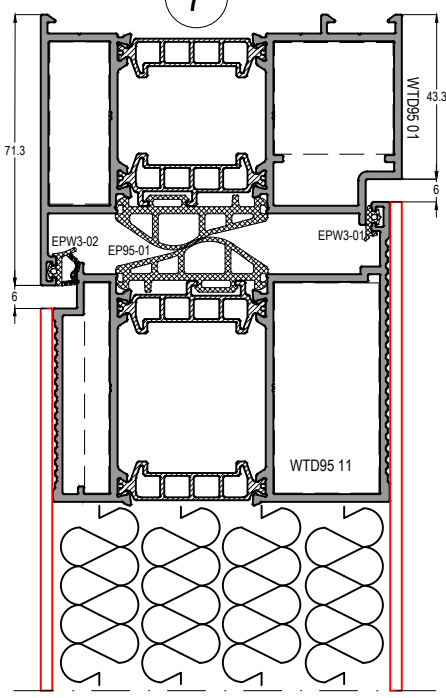

6a

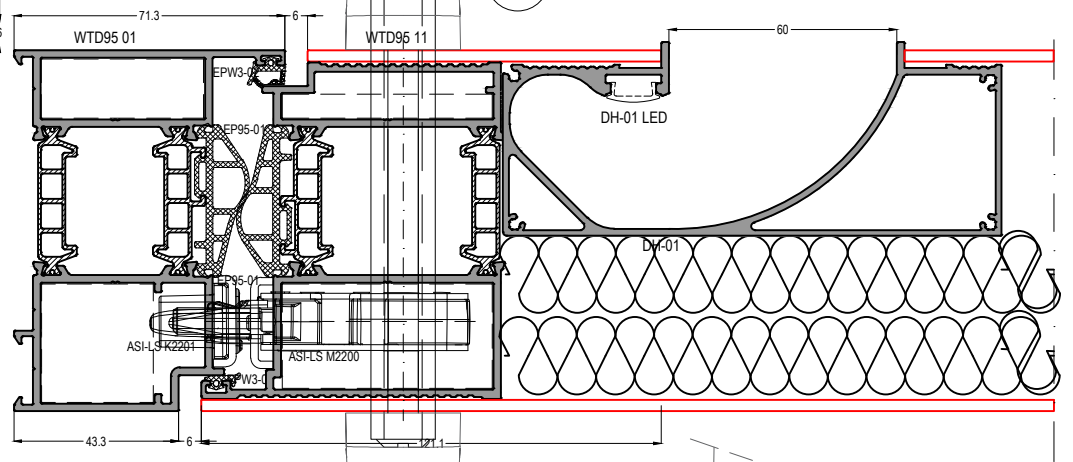
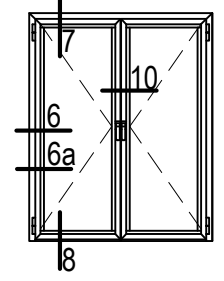

8

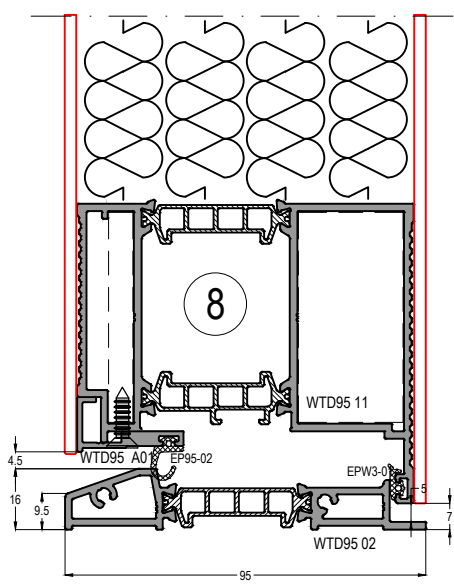

10

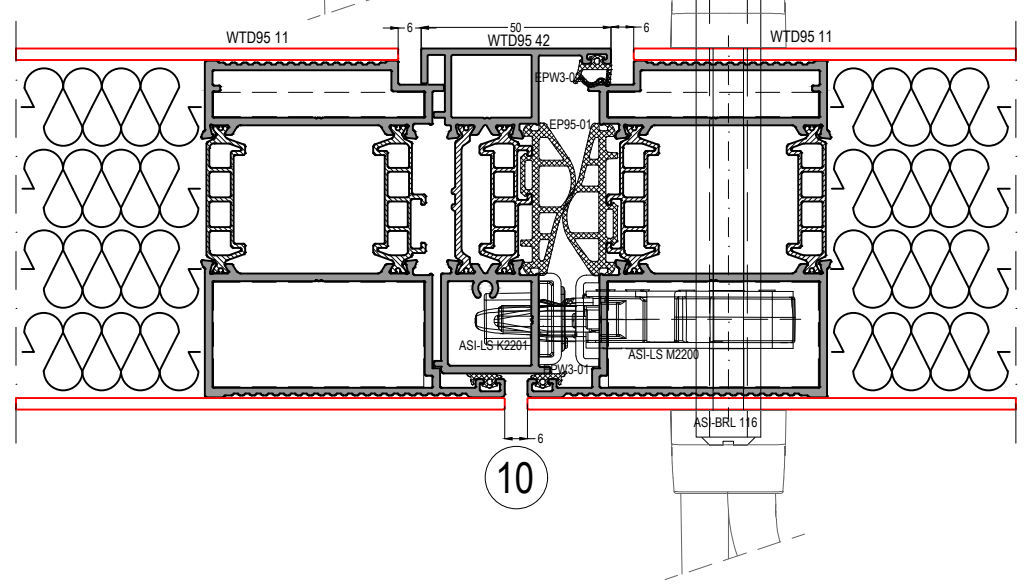

İÇE AÇILIR KAPI DETAYLARI INNER OPENING DOOR DETAILS

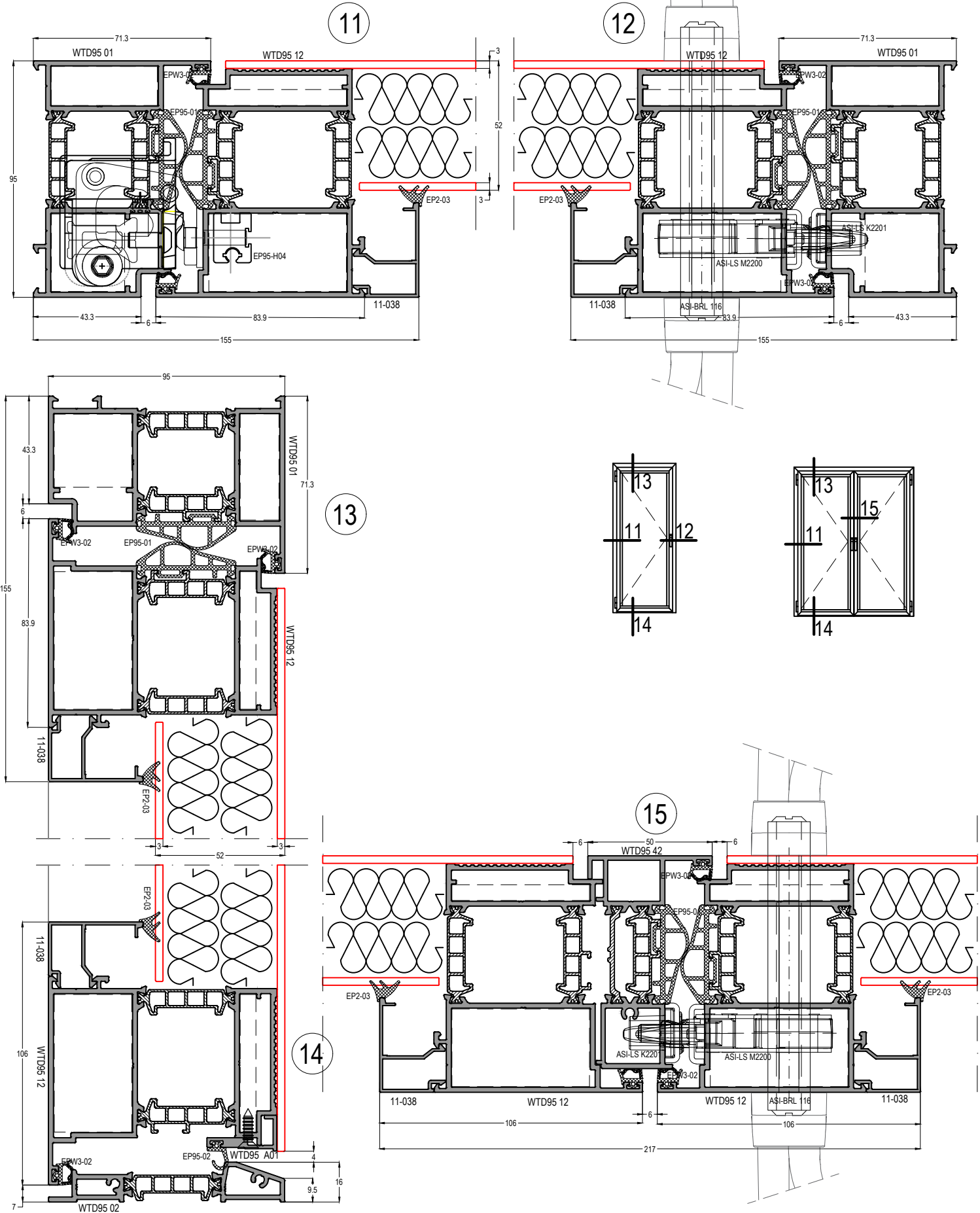

WTD95 - 2 mm

HEMYÜZ KAPI SİSTEMİ
FLAT DOOR SYSTEM



İÇE AÇILIR KAPI DETAYLARI INNER OPENING DOOR DETAILS

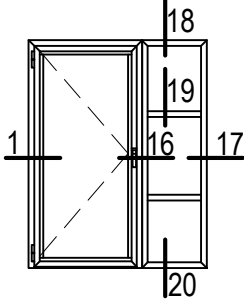

1

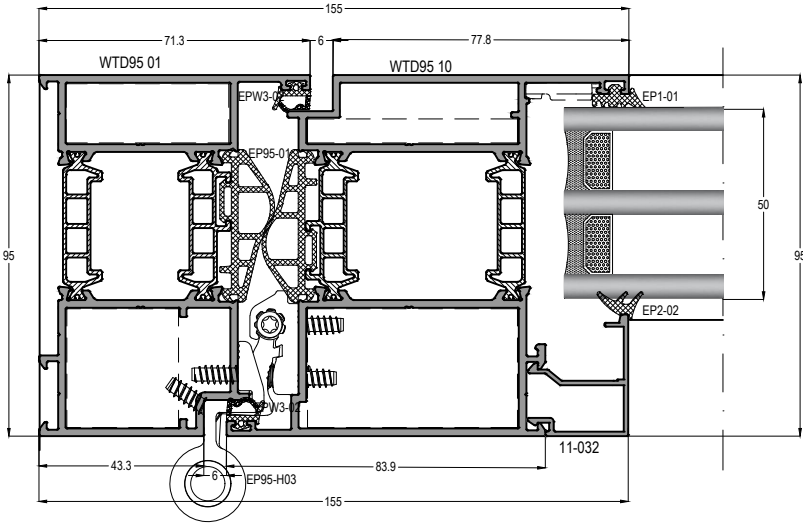

18

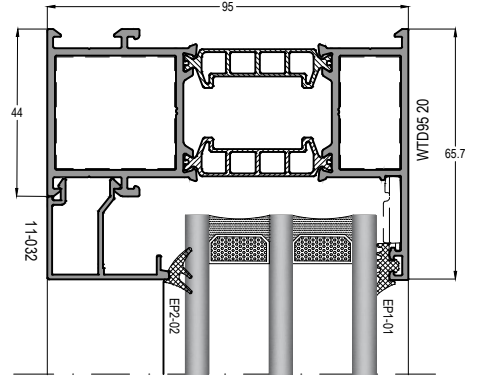

19

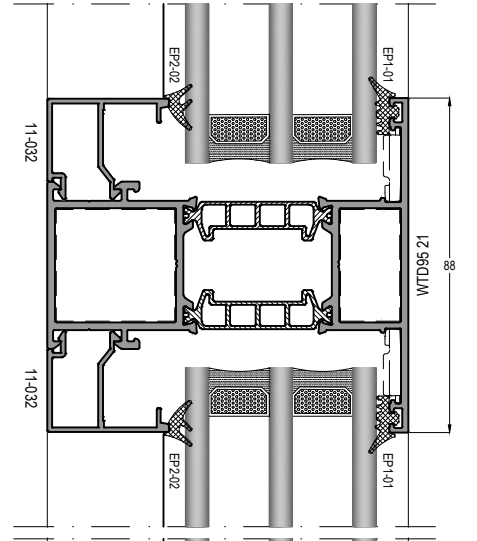

20

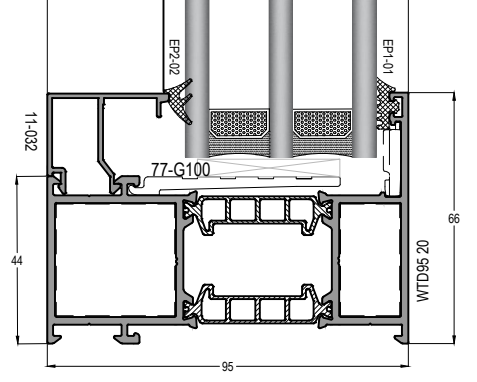

16

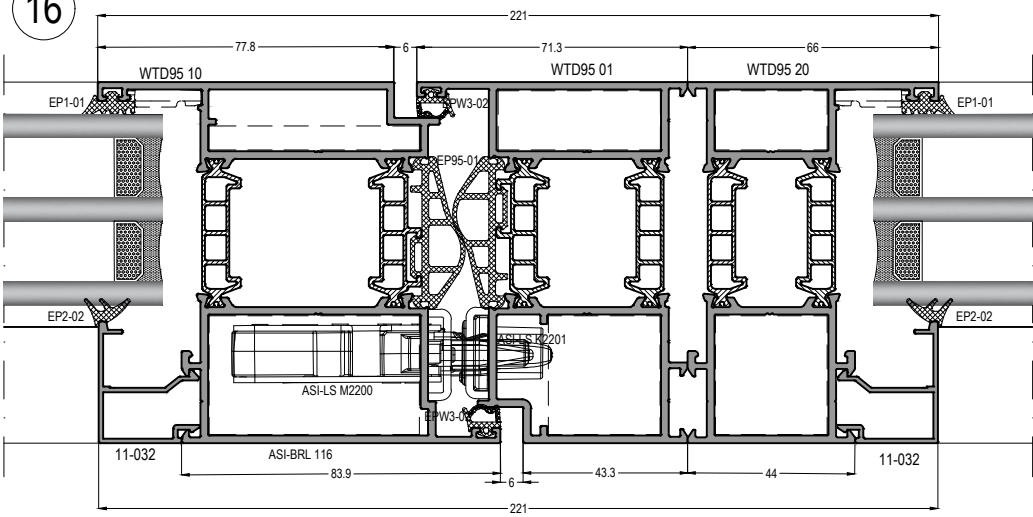

17

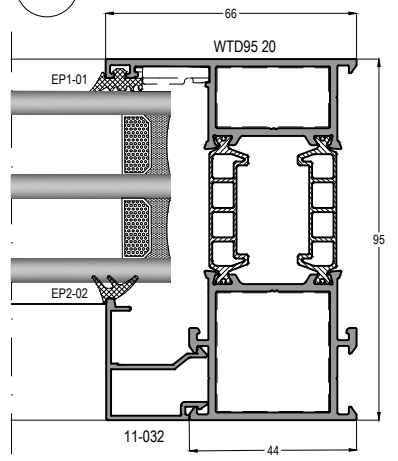



İÇE AÇILIR KAPI DETAYLARI - KOMPOZE LEVHA UYGULAMASI

INNER OPENING DOOR DETAILS

21

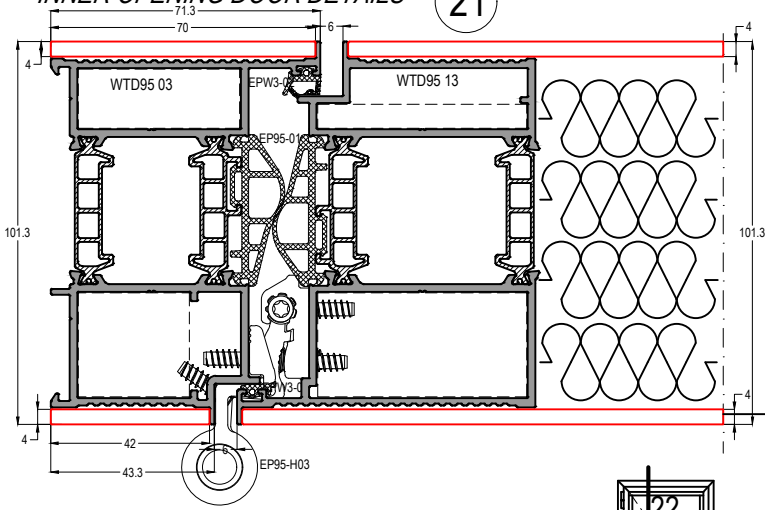

24

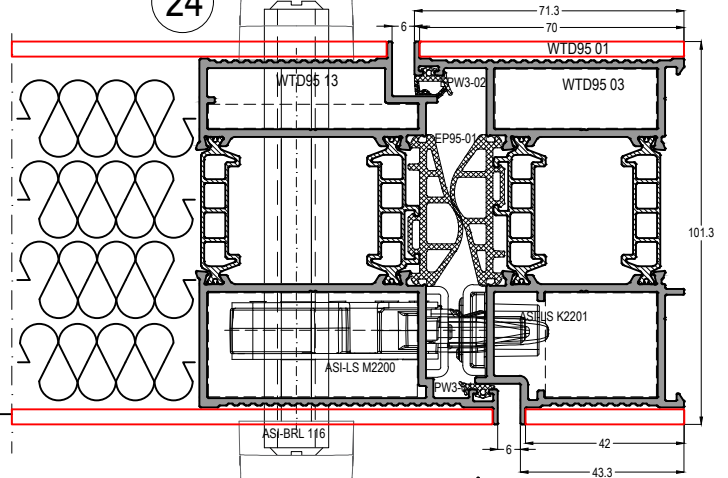

22

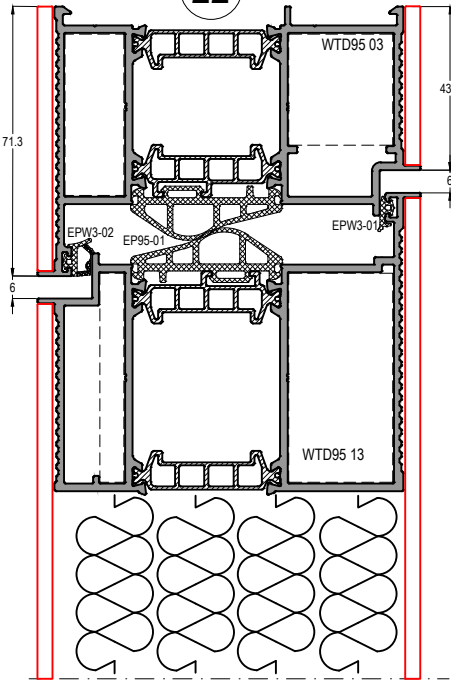

21

21a

24

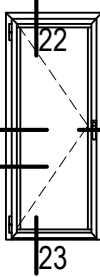

21

25

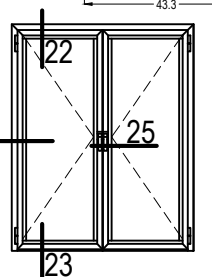

21a

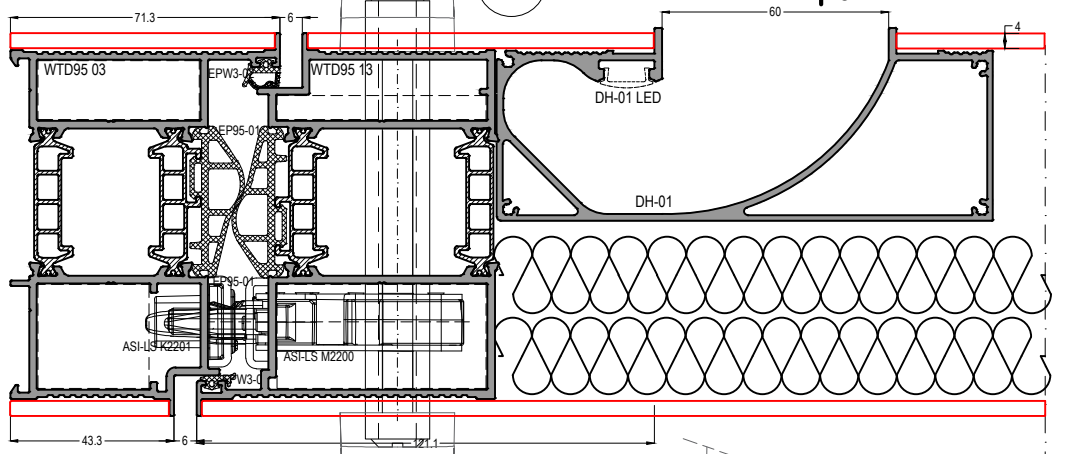

23

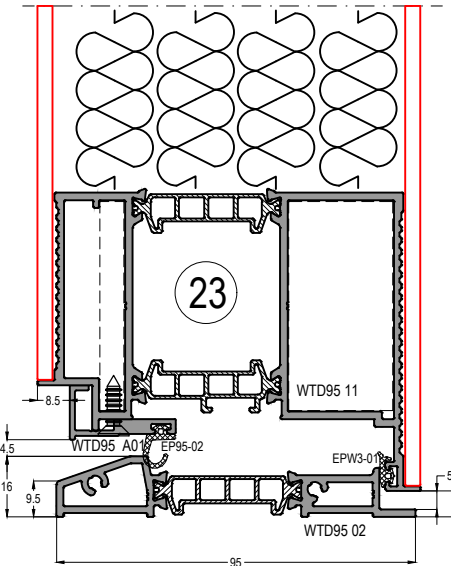

25

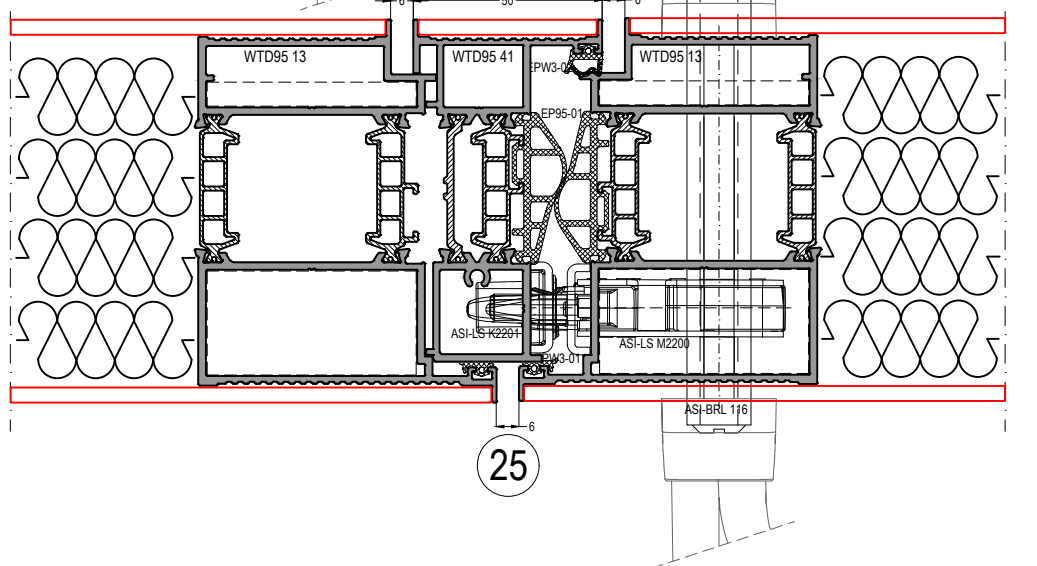

DIŞA AÇILIR KAPI DETAYLARI OUTER OPENING DOOR DETAILS

