

**GENERAL  
SYSTEM  
BROCHURE**

**GENEL  
SİSTEM  
BROŞÜR**

# HAKKIMIZDA

Marmara ve Ege bölgesinde yaygın satış ağına sahip olan ASİSTAL ALÜMİNYUM, 1994 yılından bu yana hizmet vermektedir. Fabrikamız Kırklareli Organize Sanayi Bölgesi içinde yer almakta olup, 48000 m<sup>2</sup>lik açık alan üzerinde 30000 m<sup>2</sup>lik kapalı alana kuruludur.

Son teknolojik gelişmeleri takip eden fabrikamızda; yüksek raf stok sistemine sahip yaklaşık 6500 adet kalıp içeren kalıp arşivimiz yer almaktadır. 5,6,7 ve 8 inçlik dört ekstrüzyon pres hattımız ile aylık 2500, yıllık 30000 ton kapasite ile üretim gerçekleştiriyoruz.

7 mt profil uzunluğuna kadar işlem yapabildiğimiz tam otomasyon eloksal tesisimizde; aylık 1200, yıllık 14400 ton kapasiteyle 25 mikrona kadar eloksal kaplama kalınlığı elde edebiliyor inox, bronz, kahve, siyah, sarı ve bordo renklendirme yapabiliyoruz.

7,5 mt' ye kadar işlem yapabildiğimiz bir adet yatay bir adet te dikey elektrostatik toz boya hatlarımızda aylık 2500, yıllık 30000 ton kapasite ile toz boya işlemi uyguluyoruz.

600 ton/yıl kapasiteyle Ahşap transfer hattımız ile çeşitli ahşap desenler elde ediyor, doğamızı koruyalım sloganımızla ağaçlarımızın kesilmemesine katkı sağlıyoruz.

Mekanik işleme tesisimizde; CNC, eksantrik pres ve hassas kesim testereleri ile ürünlerimizi montaja hazır hale getiriyor, Isı bariyer montaj hattımızda da mimari sistemlerimizde ısı yalıtıklığı sağlıyoruz. Yaptığımız yatırımlarla mekanik işleme kapasitemizi de arttırıyoruz.

Yeni devreye aldığımız Alüminyum Billet Dökümhane tesisimizde ilk etapta 3000 ton/ay, ikinci etapta ise 5000 ton/ay kapasiteyle; 5,6,7,8 ve 9 inç çaplarında homojenize edilmiş 1XXX, 3XXX, 5XXX ve 6XXX serisi alaşımlarında Billet dökümü gerçekleştireceğiz.

Çevreye duyarlı tesisimizde 25m<sup>3</sup>/saat kapasiteli (600 m<sup>3</sup>/gün) kimyasal arıtma ünitemiz ile geri kullanılabilir su elde edilebilmektedir.

ASİSTAL ALÜMİNYUM, balkanlar başta olmak üzere, Avrupa, orta doğu, orta Amerika ülkeleri dahil 40 ülkeye ihracat yapmaktadır.

Faaliyetlerimize ana satış mağazalarımız olan Çorlu, Tekirdağ, Edirne, İstanbul, Ankara, İzmir, Amerika New Jersey ve Bulgaristan Sofya'da devam etmekteyiz.

# ABOUT US

ASISTAL ALUMINUM, which has a widespread sales network in the Marmara and Aegean regions, has been serving since 1994. Our factory is located in Kirklareli Organized Industrial Zone and is established on an open area of 48000 m<sup>2</sup> and a closed area of 30000 m<sup>2</sup>.

In our factory, which follows the latest technological developments; We have a mold archive containing approximately 6500 molds with a high shelf stock system. We produce with a monthly capacity of 2500 tons and an annual capacity of 30000 tons with our four extrusion press lines of 5,6,7 and 8 inches.

In our fully automated anodizing facility, where we can process up to 7 meters of profile length; We can apply anodized coating thickness of up to 25 microns with a monthly capacity of 1200 tons and an annual capacity of 14400 tons, and we can color inox, bronze, brown, black, yellow and maroon.

We apply powder coating process with a monthly capacity of 2500 tons and an annual capacity of 30000 tons in our one horizontal and one vertical electrostatic powder coating lines, where we can process up to 7.5 mt.

We obtain various wooden patterns with our Wooden transfer line with a capacity of 600 tons/year, and we contribute to not cutting our trees with the slogan of "Let's protect our nature".

In our mechanical processing facility; We make our products ready for assembly with CNC, eccentric press and precision cutting saws, and we provide thermal insulation in our architectural systems in our heat barrier assembly line. We also increase our mechanical processing capacity with the investments we make.

In our newly commissioned Aluminum Billet Foundry facility, with a capacity of 3000 tons/month in the first stage and 5000 tons/month in the second stage; We will perform Billet casting in 1XXX, 3XXX, 5XXX and 6XXX series alloys homogenized in 5,6,7,8 and 9 inch diameters.

In our environmentally friendly facility, reusable water can be obtained with our chemical treatment unit with a capacity of 25m<sup>3</sup>/hour (600 m<sup>3</sup>/day). ASISTAL ALUMINYUM exports to 40 countries; Europe, the Middle East, Central America and especially the Balkans.

We continue our activities in our main sales stores in Çorlu, Tekirdağ, Edirne, İstanbul, Ankara, İzmir, USA New Jersey and Bulgaria Sofia.

# VİZYON

- Alüminyum ürün ve hizmetlerinde Türkiye'nin lider şirketleri arasında yer almak.
- Firmamızda faaliyet gösteren tüm birimler olarak Toplam Kalite Sorumluluğu bilincini taşımak.
- Verimli, güvenli ve sağlıklı bir çalışma ortamı sağlamak, iletişimi etkin kılmak, çalışanların bireysel performansını arttırmak ve bilgiyi, başarıyı ödüllendirmek için iç ve dış her türlü kaynağın en doğru ve en faydalı şekilde kullanılmasını sağlamak.

# MİSYON

Müşteri ihtiyaç ve beklentilerine en uygun alüminyum ürün ve hizmetlerini sunarak uluslararası lider şirketler arasında yer almak.

# VISION

- To operate as one of the leading companies in Turkey in aluminum products and services.
- To adopt the principle of Total Quality Responsibility in all units of our company.
- To ensure all internal and external resources are used in the most accurate and beneficial manner possible in order to create an efficient, safe, and healthy working environment, to ensure effective communication, to increase individual performance of our employees, and to reward knowledge and success.

# MISSION

- To be amongst the leading international companies by offering aluminum products and services that best suit customer needs and expectations.



# ENTEĞRE YÖNETİM SİSTEMİ POLİTİKASI

- Dünya pazarındaki rekabetin öngördüğü koşulsuz müşteri memnuniyeti için yüksek kalite ve standartlarda alüminyum profil ürünleri üretmek.
- Ulusal / Uluslararası yasal düzenlemelere eksiksiz uymak.
- Tüm faaliyetlerimizi insan ve çevre odaklı sürekli gözden geçirmek. Faaliyetlerimizden kaynaklanan olumsuz çevre etkilerini en aza indirmek, iş kazaları ve meslek hastalıklarını önlemek için gerekli tedbirleri alıp iyileştirme çalışmalarını yapmak.
- Entegre Yönetim Sistemimizi daha verimli ve etkin kılmak için çalışanlarımızın bilinç ve sorumluluğunu geliştirip yaygınlaştırmak.
- Süreçlerimizi risk odaklı yaklaşım ile yönetip, sürekli iyileştirmek.
- Ürün emniyeti ve ürün sorumluluğu kapsamında ürünlerimizin üretiminde ve kullanımında ortaya çıkabilecek uygunsuzluklar nedeniyle müşteri zinciri içinde yer alan tüm firma ve şahısların üretim faaliyetlerinin, mallarının ve canlarının zarar görmesini engellemek-en aza indirmek amacıyla uygulanacak reaksiyonları ve yetki sorumlulukları belirlemek.
- Kısıtlı doğal kaynaklarımızı etkin ve verimli kullanmak.
- Yaşam döngüsü yaklaşımı ile atıkların azaltılmasını, ayrıştırılarak yeniden kullanımını, geri dönüşümünü ve gerekli olanların yasal bertarafını sağlamak.
- Tüm rakip ve paydaşlarımıza örnek olmak. Teknolojik gelişmeler, toplumun talep, beklenti ve gereksinimlerini göz önüne alarak, politikamızla birlikte kalite, çevre ve iş sağlığı iş güvenliği uygulamalarımızı sürekli gözden geçirerek, iyileştirmek.

Asist Alüminyum Profil San. Ve Tic. A.Ş Ailesi olarak; hep birlikte, hepimiz için, ülkemiz için, dünyamız için söz veriyoruz.

**Muzaffer Engin ÖZTEL**  
Yönetim Kurulu Başkanı

# **INTEGRATED MANAGEMENT SYSTEM**

- To produce high-quality aluminum profile products in line with international standards to achieve total customer satisfaction as required by the competitive environment in the global market.
- To ensure full compliance with national / international regulations.
- To constantly review all of our activities with a focus on people and environment. To minimize the negative environmental effects caused by our activities, to take necessary measures to prevent occupational accidents and diseases, and to make improvement efforts.
- To improve the awareness and responsibility level of our employees in order to achieve a more efficient and effective integrated management system.
- To manage and improve our processes with a risk-oriented approach.
- To define responsibilities and reactions to be performed in order to prevent / minimize damages to production activities, goods, and lives of all persons and companies involved in the customer chain due to possible non-conformities in the manufacturing and use of our products within the scope of product safety and product responsibility.
- To use our limited natural resources effectively and efficiently.
- To ensure reduction, sorting, reuse, and recycling of waste and lawful disposal of necessary waste with the life cycle approach.
- To be an example to all our competitors and stakeholders. To continuously review and improve our quality, environment, and occupational safety and safety practices together with our policies taking into account the technological developments, demands, expectations, and requirements of the society.

As Asistal family, we promise all together, for all of us, for our country, for our world.

**Muzaffer Engin ÖZTEL**  
Chairman of The Board of Directors

# SERTİFİKALAR

## CERTIFICATES



IATF 16949:2016



ISO 9001



ISO 14001



ISO 45001



CE EN 15088 CPR



CE EN 15088 CPR



TS EN 755-1



TS EN 12020



TS 4922



QUALANOD



QUALICOAT SEASIDE



# TEST RAPORLARI

## TEST REPORTS



**Asistal FC50 AS**



**Asistal TH 68**



**Asistal LS 60**



**Asistal TE 62**



**Asistal TH 78**



**Asistal TH 62**



**Asistal TM55**



## TM55

### YALITIMLI KAPI & PENCERE SİSTEMLERİ

INSULATED DOOR AND WINDOW SYSTEMS



TEKNİK KATALOG  
TECHNICAL CATALOG

**KASA GENİŞLİĞİ:** 55 mm

**KANAT GENİŞLİĞİ:** 59 mm

**SİSTEM ET KALINLIĞI:** 1,6 - 2 mm

**ISI BARIYERİ:** 14,8 mm **Kasa - Kanat (UF)** 3,24 W(M<sup>2</sup>.K)

**CAM KALINLIĞI:** 4 – 40 mm

**AKSESUAR SEÇİMİ:** Euro norm kanallı profiller, PVC aksesuarına uygun profiller (Multi Point Lock)

**AÇILIM TİPLERİ:** Tek kanat pencere çift kanat pencere, vasistas açılım, içe açılır tek kanat kapı, içe açılır çift kanat kapı, dışa açılır tek kanat kapı, dışa açılır çift kanat kapı, katlanır kapı, paralel sürme.

**FRAME WIDTH:** 55 mm

**SASH WIDTH:** 59 mm

**SYSTEM WALL THICKNESS:** 1,6 - 2 mm

**INSULATION BARRIER:** 14,8 mm **Frame - Sash (UF)** 3,24 W(M<sup>2</sup>.K)

**GLASS THICKNESS:** 4 – 40 mm

**ACCESSORY SELECTION:** Profiles with Euronorm channels, Profiles suitable for PVC accessory (Multi Point Lock)

**OPENING TYPES:** Single-sash window, double-sash window, transom window, inward-opening single sash door, inward-opening double-sash door, outward-opening single-sash door, outward-opening double-sash door, folding door, parallel sliding.



## TH55

### YALITIMLI KAPI & PENCERE SİSTEMLERİ

INSULATED DOOR AND WINDOW SYSTEMS



TEKNİK KATALOG  
TECHNICAL CATALOG

**KASA GENİŞLİĞİ:** 55 mm

**KANAT GENİŞLİĞİ:** 59 mm

**SİSTEM ET KALINLIĞI:** 1,8 mm

**ISI BARIYERİ:** 14,8 mm **Kasa - Kanat (UF)** 3,31 W(M<sup>2</sup>.K)

**CAM KALINLIĞI:** 4 – 40 mm

**AKSESUAR SEÇİMİ:** Euro norm kanallı profiller, PVC aksesuarına uygun profiller (Multi Point Lock)

**AÇILIM TİPLERİ:** Tek kanat pencere çift kanat pencere, vasistas açılım, içe açılır tek kanat kapı, içe açılır çift kanat kapı, dışa açılır tek kanat kapı, dışa açılır çift kanat kapı, katlanır kapı, paralel sürme.

**FRAME WIDTH:** 55 mm

**SASH WIDTH:** 59 mm

**SYSTEM WALL THICKNESS:** 1,8 mm

**INSULATION BARRIER:** 14,8 mm **Frame - Sash (UF)** 3,31 W(M<sup>2</sup>.K)

**GLASS THICKNESS:** 4 – 40 mm

**ACCESSORY SELECTION:** Profiles with Euronorm channels, Profiles suitable for PVC accessory (Multi Point Lock)

**OPENING TYPES:** Single-sash window, double-sash window, transom window, inward-opening single sash door, inward-opening double-sash door, outward-opening single-sash door, outward-opening double-sash door, folding door, parallel sliding.



## TE56

**YALITIMLI KAPI &  
PENCERE SİSTEMLERİ**  
INSULATED DOOR AND  
WINDOW SYSTEMS



TEKNİK KATALOG  
TECHNICAL CATALOG

**KASA GENİŞLİĞİ:** 56 mm

**KANAT GENİŞLİĞİ:** 59 mm

**SİSTEM ET KALINLIĞI:** 1,3 mm

**ISI BARIYERİ:** 18 mm  **Kasa - Kanat (UF)** 3,03 W(M<sup>2</sup>.K)

**CAM KALINLIĞI:** 4 – 40 mm

**AKSESUAR SEÇİMİ:** Euro norm kanallı profiller,  
PVC aksesuarına uygun profiller (Multi Point Lock)

**AÇILIM TİPLERİ:** Tek kanat pencere çift kanat pencere, vasistas açılım, içe açılır tek kanat kapı, içe açılır çift kanat kapı, dışa açılır tek kanat kapı, dışa açılır çift kanat kapı, katlanır kapı, paralel sürme.

**FRAME WIDTH:** 56 mm

**SASH WIDTH:** 59 mm

**SYSTEM WALL THICKNESS:** 1,3 mm

**INSULATION BARRIER:** 18 mm  **Frame - Sash (UF)** 3,03 W(M<sup>2</sup>.K)

**GLASS THICKNESS:** 4 – 40 mm

**ACCESSORY SELECTION:** Profiles with Euronorm channels, Profiles suitable for PVC accessory (Multi Point Lock)

**OPENING TYPES:** Single-sash window, double-sash window, transom window, inward-opening single sash door, inward-opening double-sash door, outward-opening single-sash door, outward-opening double-sash door, folding door, parallel sliding.



## TE62

**YALITIMLI KAPI &  
PENCERE SİSTEMLERİ**  
INSULATED DOOR AND  
WINDOW SYSTEMS



TEKNİK KATALOG  
TECHNICAL CATALOG

**KASA GENİŞLİĞİ:** 62 mm

**KANAT GENİŞLİĞİ:** 65 mm

**SİSTEM ET KALINLIĞI:** 1,3 mm

**ISI BARIYERİ:** 24 mm  **Kasa - Kanat (UF)** 2,82 W(M<sup>2</sup>.K)

**CAM KALINLIĞI:** 10 – 45 mm

**AKSESUAR SEÇİMİ:** Euro norm kanallı profiller,  
PVC aksesuarına uygun profiller (Multi Point Lock)

**AÇILIM TİPLERİ:** Tek kanat pencere çift kanat pencere, vasistas açılım, içe açılır tek kanat kapı, içe açılır çift kanat kapı, dışa açılır tek kanat kapı, dışa açılır çift kanat kapı, katlanır kapı, paralel sürme.

**FRAME WIDTH:** 62 mm

**SASH WIDTH:** 65 mm

**SYSTEM WALL THICKNESS:** 1,3 mm

**INSULATION BARRIER:** 24 mm  **Frame - Sash (UF)** 2,82 W(M<sup>2</sup>.K)

**GLASS THICKNESS:** 10 – 45 mm

**ACCESSORY SELECTION:** Profiles with Euronorm channels, Profiles suitable for PVC accessory (Multi Point Lock)

**OPENING TYPES:** Single-sash window, double-sash window, transom window, inward-opening single sash door, inward-opening double-sash door, outward-opening single-sash door, outward-opening double-sash door, folding door, parallel sliding.



## TH62 - THS62

**YALITIMLI KAPI & PENCERE SİSTEMLERİ**  
INSULATED DOOR AND WINDOW SYSTEMS



TEKNİK KATALOG  
TECHNICAL CATALOG

**KASA GENİŞLİĞİ:** 62 mm

**KANAT GENİŞLİĞİ:** 65 mm

**SİSTEM ET KALINLIĞI:** 1,8 mm

**ISI BARIYERİ:** 18 mm  **Kasa - Kanat (UF)** 3,12 W(M<sup>2</sup>.K)

**CAM KALINLIĞI:** 10 – 45 mm

**AKSESUAR SEÇİMİ:** Euro norm kanallı profiller, PVC aksesuarına uygun profiller (Multi Point Lock)

**AÇILIM TİPLERİ:** Tek kanat pencere çift kanat pencere, vasistas açılım, pivot açılım, içe açılır tek kanat kapı, içe açılır çift kanat kapı, dışa açılır tek kanat kapı, dışa açılır çift kanat kapı, katlanır kapı, paralel sürme.

**FRAME WIDTH:** 62 mm

**SASH WIDTH:** 65 mm

**SYSTEM WALL THICKNESS:** 1,8 mm

**INSULATION BARRIER:** 18 mm  **Frame - Sash (UF)** 3,12 W(M<sup>2</sup>.K)

**GLASS THICKNESS:** 10 – 45 mm

**ACCESSORY SELECTION:** Profiles with Euronorm channels, Profiles suitable for PVC accessory (Multi Point Lock)

**OPENING TYPES:** Single-sash window, double-sash window, transom window, pivot window, inward-opening single sash door, inward-opening double-sash door, outward-opening single-sash door, outward-opening double-sash door, folding door, parallel sliding.



## TH68 - THS68

**YALITIMLI KAPI & PENCERE SİSTEMLERİ**  
INSULATED DOOR AND WINDOW SYSTEMS



TEKNİK KATALOG  
TECHNICAL CATALOG

**KASA GENİŞLİĞİ:** 68 mm

**KANAT GENİŞLİĞİ:** 71 mm

**SİSTEM ET KALINLIĞI:** 1,8 mm

**ISI BARIYERİ:** 24 mm  **Kasa - Kanat (UF)** 2,79 W(M<sup>2</sup>.K)

**CAM KALINLIĞI:** 16 – 55 mm

**AKSESUAR SEÇİMİ:** Euro norm kanallı profiller, PVC aksesuarına uygun profiller (Multi Point Lock)

**AÇILIM TİPLERİ:** Tek kanat pencere çift kanat pencere, vasistas açılım, içe açılır tek kanat kapı, içe açılır çift kanat kapı, dışa açılır tek kanat kapı, dışa açılır çift kanat kapı, katlanır kapı, paralel sürme.

**FRAME WIDTH:** 68 mm

**SASH WIDTH:** 71 mm

**SYSTEM WALL THICKNESS:** 1,8 mm

**INSULATION BARRIER:** 24 mm  **Frame - Sash (UF)** 2,79 W(M<sup>2</sup>.K)

**GLASS THICKNESS:** 16 – 55 mm

**ACCESSORY SELECTION:** Profiles with Euronorm channels, Profiles suitable for PVC accessory (Multi Point Lock)

**OPENING TYPES:** Single-sash window, double-sash window, transom window, inward-opening single sash door, inward-opening double-sash door, outward-opening single-sash door, outward-opening double-sash door, folding door, parallel sliding.



## TH78 - THS78

**YALITIMLI KAPI &  
PENCERE SİSTEMLERİ**  
INSULATED DOOR AND  
WINDOW SYSTEMS



TEKNİK KATALOG  
TECHNICAL CATALOG

**KASA GENİŞLİĞİ:** 78 mm

**KANAT GENİŞLİĞİ:** 81 mm

**SİSTEM ET KALINLIĞI:** 1,8 mm

**ISI BARIYERİ:** 34 mm  **Kasa - Kanat (UF)** 1,93 W(M<sup>2</sup>.K)

**CAM KALINLIĞI:** 26 – 45 mm

**AKSESUAR SEÇİMİ:** Euro norm kanallı profiller,  
PVC aksesuarına uygun profiller (Multi Point Lock)

**AÇILIM TİPLERİ:** Tek kanat pencere çift kanat pencere, vasistas açılım, içe açılır tek kanat kapı, içe açılır çift kanat kapı, dışa açılır tek kanat kapı, dışa açılır çift kanat kapı, katlanır kapı, paralel sürme.

**FRAME WIDTH:** 78 mm

**SASH WIDTH:** 81 mm

**SYSTEM WALL THICKNESS:** 1,8 mm

**INSULATION BARRIER:** 34 mm  **Frame - Sash (UF)** 1,93 W(M<sup>2</sup>.K)

**GLASS THICKNESS:** 26 – 45 mm

**ACCESSORY SELECTION:** Profiles with Euronorm channels, Profiles suitable for PVC accessory (Multi Point Lock)

**OPENING TYPES:** Single-sash window, double-sash window, transom window, inward-opening single sash door, inward-opening double-sash door, outward-opening single-sash door, outward-opening double-sash door, folding door, parallel sliding.



## TH62 HV

**YALITIMLI KAPI &  
PENCERE SİSTEMLERİ**  
INSULATED DOOR AND  
WINDOW SYSTEMS



TEKNİK KATALOG  
TECHNICAL CATALOG

**KASA GENİŞLİĞİ:** 62 mm

**KANAT GENİŞLİĞİ:** 65 mm  **Kasa - Kanat (UF)** 2,99 W(M<sup>2</sup>.K)

**SİSTEM ET KALINLIĞI** 1,8 mm

**ISI BARIYERİ:** 18 mm

**CAM KALINLIĞI:** 24 mm

**AKSESUAR SEÇİMİ:** Euro norm kanallı profiller

**FRAME WIDTH:** 62 mm

**SASH WIDTH:** 65 mm

**SYSTEM WALL THICKNESS:** 1,8 mm

**INSULATION BARRIER:** 18 mm  **Frame - Sash (UF)** 2,99 W(M<sup>2</sup>.K)

**GLASS THICKNESS:** 24 mm

**ACCESSORY SELECTION:** Profiles with Euronorm channels



# TH68 HV

## YALITIMLI KAPI & PENCERE SİSTEMLERİ

INSULATED DOOR AND WINDOW SYSTEMS



TEKNİK KATALOG  
TECHNICAL CATALOG

KASA GENİŞLİĞİ: 68 mm

KANAT GENİŞLİĞİ: 71 mm

SİSTEM ET KALINLIĞI: 1,8 mm

ISI BARIYERİ: 24 mm  Kasa - Kanat (UF) 2,67 W(M<sup>2</sup>.K)

CAM KALINLIĞI: 30 mm

AKSESUAR SEÇİMİ: Euro norm kanallı profiller

FRAME WIDTH: 68 mm

SASH WIDTH: 71 mm

SYSTEM WALL THICKNESS: 1,8 mm

INSULATION BARRIER: 24 mm  Frame - Sash (UF) 2,67 W(M<sup>2</sup>.K)

GLASS THICKNESS: 30 mm

ACCESSORY SELECTION: Profiles with Euronorm channels



# AS38

## YALITIMSIZ KAPI & PENCERE SİSTEMLERİ

UNINSULATED DOOR AND WINDOW SYSTEMS



TEKNİK KATALOG  
TECHNICAL CATALOG

KASA GENİŞLİĞİ: 37 mm

KANAT GENİŞLİĞİ: 44,5 mm

SİSTEM ET KALINLIĞI: 1,2 mm

CAM KALINLIĞI: 4 – 22 mm

AKSESUAR SEÇİMİ: Euro norm kanallı profiller

**AÇILIM TİPLERİ:** Tek kanat pencere çift kanat pencere, vasistas açılım, içe açılır tek kanat kapı, içe açılır çift kanat kapı, dışa açılır tek kanat kapı, dışa açılır çift kanat kapı.

FRAME WIDTH: 37 mm

SASH WIDTH: 44,5 mm

SYSTEM WALL THICKNESS: 1,2 mm

GLASS THICKNESS: 4 – 22 mm

ACCESSORY SELECTION: Profiles with Euronorm channels.

**OPENING TYPES:** Single-sash window, double-sash window, transom window, inward-opening single sash door, inward-opening double-sash door, outward-opening single-sash door, outward-opening double-sash door.



## AS42

### YALITIMSIZ KAPI & PENCERE SİSTEMLERİ

UNINSULATED DOOR AND WINDOW SYSTEMS



TEKNİK KATALOG  
TECHNICAL CATALOG

**KASA GENİŞLİĞİ:** 42 mm

**KANAT GENİŞLİĞİ:** 44 mm

**SİSTEM ET KALINLIĞI:** 1,2 mm

**CAM KALINLIĞI:** 4 – 24 mm

**AKSESUAR SEÇİMİ:** Euro norm kanallı profiller, PVC aksesuarına uygun profiller (Multi Point Lock)

**AÇILIM TİPLERİ:** Tek kanat pencere çift kanat pencere, vasistas açılım, içe açılır tek kanat kapı, içe açılır çift kanat kapı, dışa açılır tek kanat kapı, dışa açılır çift kanat kapı.

**FRAME WIDTH:** 42 mm

**SASH WIDTH:** 44 mm

**SYSTEM WALL THICKNESS:** 1,2 mm

**GLASS THICKNESS:** 4 – 24 mm

**ACCESSORY SELECTION:** Profiles with Euronorm channels, Profiles suitable for PVC accessory (Multi Point Lock)

**OPENING TYPES:** Single-sash window, double-sash window, transom window, inward-opening single sash door, inward-opening double-sash door, outward-opening single-sash door, outward-opening double-sash door.



## AS50

### YALITIMSIZ KAPI & PENCERE SİSTEMLERİ

UNINSULATED DOOR AND WINDOW SYSTEMS



TEKNİK KATALOG  
TECHNICAL CATALOG

**KASA GENİŞLİĞİ:** 50 mm (Oval ve düz kasa seçeneği)

**KANAT GENİŞLİĞİ:** 58 mm

**SİSTEM ET KALINLIĞI:** 1,4 mm

**CAM KALINLIĞI:** 4 – 32 mm

**AKSESUAR SEÇİMİ:** Euro norm kanallı profiller, PVC aksesuarına uygun profiller (Multi Point Lock)

**AÇILIM TİPLERİ:** Tek kanat pencere çift kanat pencere, vasistas açılım, içe açılır tek kanat kapı, içe açılır çift kanat kapı, dışa açılır tek kanat kapı, dışa açılır çift kanat kapı.

**FRAME WIDTH:** 50 mm (Oval and flat frame options)

**SASH WIDTH:** 58 mm

**SYSTEM WALL THICKNESS:** 1,4 mm

**GLASS THICKNESS:** 4 – 32 mm

**ACCESSORY SELECTION:** Profiles with Euronorm channels, Profiles suitable for PVC accessory (Multi Point Lock)

**OPENING TYPES:** Single-sash window, double-sash window, transom window, inward-opening single sash door, inward-opening double-sash door, outward-opening single-sash door, outward-opening double-sash door.



## C55

### YALITIMSIZ KAPI & PENCERE SİSTEMLERİ

UNINSULATED DOOR AND WINDOW SYSTEMS



TEKNİK KATALOG  
TECHNICAL CATALOG

**KASA GENİŞLİĞİ:** 55 mm

**KANAT GENİŞLİĞİ:** 58 mm

**SİSTEM ET KALINLIĞI:** 1,4 mm

**CAM KALINLIĞI:** 4 – 40 mm

**AÇILIM TİPLERİ:** Tek kanat pencere çift kanat pencere, vasistas açılım, pivot açılım, içe açılır tek kanat kapı, içe açılır çift kanat kapı, dışa açılır tek kanat kapı, dışa açılır çift kanat kapı, çarpma kapı, katlanır kapı, paralel sürme.

**FRAME WIDTH:** 55 mm

**SASH WIDTH:** 58 mm

**SYSTEM WALL THICKNESS:** 1,4 mm

**GLASS THICKNESS:** 4 – 40 mm

**OPENING TYPES:** Single-sash window, double-sash window, transom window, pivot window, inward-opening single sash door, inward-opening double-sash door, outward-opening single-sash door, outward-opening double-sash door, swinging door, folding door, parallel sliding.



## AS C60

### YALITIMSIZ KAPI & PENCERE SİSTEMLERİ

UNINSULATED DOOR AND WINDOW SYSTEMS



TEKNİK KATALOG  
TECHNICAL CATALOG

**KASA GENİŞLİĞİ:** 60 mm

**KANAT GENİŞLİĞİ:** 60 mm

**SİSTEM ET KALINLIĞI:** 1,5 mm

**CAM KALINLIĞI:** 4, 6, 8, 10, 16, 18 mm

**AÇILIM TİPLERİ:** Single-sash door, double-sash door, swinging door, fixed display window application

**FRAME WIDTH:** 60 mm

**SASH WIDTH:** 60 mm

**SYSTEM WALL THICKNESS:** 1,5 mm

**GLASS THICKNESS:** 4, 6, 8, 10, 16, 18 mm

**OPENING TYPES:** Single-sash door, double-sash door, swinging door, fixed display window application





# SL34T

## YALITIMLI SÜRME SİSTEMLER

### INSULATED SLIDING SYSTEMS



TEKNİK KATALOG  
TECHNICAL CATALOG



MONTAJ KATALOĞU  
ASSEMBLY CATALOG

**KASA GENİŞLİĞİ:** 79 mm - 87 mm - 118 mm

**KANAT GENİŞLİĞİ:** 34 mm

**SİSTEM ET KALINLIĞI:** 1,2 mm

**ISI BARIYERİ:** Kasa: 20 mm - Kanat: 14,8 mm

**KANAT TAŞIMA KAPASİTESİ:** 160 kg

**AÇILIM TİPLERİ:** İkili hareketli kanat, dörtlü hareketli kanat, sineklikli kanat.

**FRAME WIDTH:** 97 mm - 87 mm - 118 mm

**SASH WIDTH:** 34 mm

**SYSTEM WALL THICKNESS:** 1,4 mm

**INSULATION BARRIER:** Frame: 20 mm - Sash: 14,8 mm

**SASH CARRY CAPACITY:** 160 kg

**OPENING TYPES:** Two moving sashes, four moving sashes, sash with screen rail.



# SL38T-N

## YALITIMLI SÜRME SİSTEMLER

### INSULATED SLIDING SYSTEMS



TEKNİK KATALOG  
TECHNICAL CATALOG



MONTAJ KATALOĞU  
ASSEMBLY CATALOG

**KASA GENİŞLİĞİ:** 94 mm - 107 mm - 144 mm

**KANAT GENİŞLİĞİ:** 38 mm - Cam Çıtasız ve Cam Çıtalı Kanat

**SİSTEM ET KALINLIĞI:** 1,4 mm

**ISI BARIYERİ:** Kasa: 24 mm - Kanat: 20 mm

**KANAT TAŞIMA KAPASİTESİ:** 160 kg

**AÇILIM TİPLERİ:** İkili hareketli kanat, dörtlü hareketli kanat, altılı hareketli kanat, sineklikli kanat.

**FRAME WIDTH:** 94 mm - 107 mm - 144 mm

**SASH WIDTH:** 38 mm - Sash with and without glazing molding

**SYSTEM WALL THICKNESS:** 1,4 mm

**INSULATION BARRIER:** Frame: 24 mm - Sash: 20 mm

**SASH CARRY CAPACITY:** 160 kg

**OPENING TYPES:** Two moving sashes, four moving sashes, six moving sashes, sash with screen rail.



# SL38T-K

**YALITIMLI  
KALDIR SÜR SİSTEMLER**

**INSULATED  
LIFT & SLIDE SYSTEMS**



**TEKNİK KATALOG  
TECHNICAL CATALOG**



**MONTAJ KATALOĞU  
ASSEMBLY CATALOG**

**KASA GENİŞLİĞİ:** 94 mm - 107 mm - 144 mm

**KANAT GENİŞLİĞİ:** 38 mm - Cam Çıtasız ve Cam Çıtalı Kanat

**SİSTEM ET KALINLIĞI:** 1,4 mm

**ISI BARIYERİ:** Kasa: 24 mm, Kanat: 20 mm

**KANAT TAŞIMA KAPASİTESİ:** 200 kg

**AÇILIM TİPLERİ:** İkili hareketli kanat, dördü hareketli kanat, altılı hareketli kanat, sineklikli kanat.

**FRAME WIDTH:** 94 mm - 107 mm - 144 mm

**SASH WIDTH:** 38 mm - Sash with and without glazing molding

**SYSTEM WALL THICKNESS:** 1,4 mm

**INSULATION BARRIER:** Frame: 24 mm - Sash: 20 mm

**SASH CARRY CAPACITY:** 200 kg

**OPENING TYPES:** Two moving sashes, four moving sashes, six moving sashes, sash with screen rail.



# SL40T

**YALITIMLI  
SÜRME SİSTEMLER**

**INSULATED  
SLIDING SYSTEMS**



**TEKNİK KATALOG  
TECHNICAL CATALOG**



**MONTAJ KATALOĞU  
ASSEMBLY CATALOG**

**KASA GENİŞLİĞİ:** 93 mm - 115 mm - 146 mm

**KANAT GENİŞLİĞİ:** 38 mm - Cam Çıtasız ve Cam Çıtalı Kanat

**SİSTEM ET KALINLIĞI:** 1,4 mm

**ISI BARIYERİ:** Kasa: 18 mm - Kanat: 14,8 mm

**CAM KALINLIĞI:** 4 - 28 mm

**KANAT TAŞIMA KAPASİTESİ:** 160 kg

**AÇILIM TİPLERİ:** İkili hareketli kanat, dördü hareketli kanat, altılı hareketli kanat, kendinden sabit kanatlı kasa ile hareketli tek kanat, sineklikli kanat.

**FRAME WIDTH:** 93 mm - 115 mm - 146 mm

**SASH WIDTH:** 38 mm - Sash with and without glazing molding

**SYSTEM WALL THICKNESS:** 1,4 mm

**INSULATION BARRIER:** Frame: 18 mm - Sash: 14,8 mm

**GLASS THICKNESS:** 4 - 28 mm

**SASH CARRY CAPACITY:** 160 kg

**OPENING TYPES:** Two moving sashes, four moving sashes, six moving sashes, self-fixed sash and single moving sash, sash with screen rail.



## LS60

### YALITIMLI KALDIR SÜR SİSTEMLER

#### INSULATED LIFT & SLIDE SYSTEMS



TEKNİK KATALOG  
TECHNICAL CATALOG



MONTAJ KATALOĞU  
ASSEMBLY CATALOG

**KASA GENİŞLİĞİ:** 69 mm - 136 mm - 145 mm - 221 mm

**KANAT GENİŞLİĞİ:** 60 mm

**SİSTEM ET KALINLIĞI:** 1,8 mm

**ISI BARIYERİ:** Kasa: 24 mm, Kanat: 14,8 mm

**CAM KALINLIĞI:** 10 - 46 mm

**KANAT TAŞIMA KAPASİTESİ:** 300 kg

**AÇILIM TİPLERİ:** İkili hareketli kanat, dörtlü hareketli kanat, altılı hareketli kanat, kendinden sabit kanatlı kasa ile hareketli tek kanat, sineklikli kanat.

**FRAME WIDTH:** 69 mm - 136 mm - 145 mm - 221 mm

**SASH WIDTH:** 60 mm

**SYSTEM WALL THICKNESS:** 1,8 mm

**INSULATION BARRIER:** Frame: 24 mm - Sash: 14,8 mm

**GLASS THICKNESS:** 10 - 46 mm

**SASH CARRY CAPACITY:** 300 kg

**OPENING TYPES:** Two moving sashes, four moving sashes, six moving sashes, self-fixed sash and single moving sash, sash with screen rail.



## LS70

### YALITIMLI KALDIR SÜR SİSTEMLER

#### INSULATED LIFT & SLIDE SYSTEMS



TEKNİK KATALOG  
TECHNICAL CATALOG



MONTAJ KATALOĞU  
ASSEMBLY CATALOG

**KASA GENİŞLİĞİ:** 159 mm - 167 mm - 197 mm - 257 mm

**KANAT GENİŞLİĞİ:** 70 mm

**SİSTEM ET KALINLIĞI:** 1,8 mm

**ISI BARIYERİ:** Kasa: 24 mm, Kanat: 24 mm

**CAM KALINLIĞI:** 18 - 52 mm

**KANAT TAŞIMA KAPASİTESİ:** 300 kg / 400 kg

**AÇILIM TİPLERİ:** İkili hareketli kanat, dörtlü hareketli kanat, sineklikli kanat.

**FRAME WIDTH:** 159 mm - 167 mm - 197 mm - 257 mm

**SASH WIDTH:** 70 mm

**SYSTEM WALL THICKNESS:** 1,8 mm

**INSULATION BARRIER:** Frame: 24 mm - Sash: 24 mm

**GLASS THICKNESS:** 18 - 52 mm

**SASH CARRY CAPACITY:** 300 kg / 400 kg

**OPENING TYPES:** Two moving sashes, four moving sashes, sash with screen rail.



## SL28

**YALITIMSIZ  
SÜRME SİSTEMLER**  
UNINSULATED  
SLIDING SYSTEMS



TEKNİK KATALOG  
TECHNICAL CATALOG



MONTAJ KATALOĞU  
ASSEMBLY CATALOG

**KASA GENİŞLİĞİ:** 45 mm - 76 mm - 81 mm

**KANAT GENİŞLİĞİ:** 28 mm - Cam Çıtasız Kanat

**SİSTEM ET KALINLIĞI:** 1,2 mm

**CAM KALINLIĞI:** 4, 6, 8, 16, 18, 20 mm

**KANAT TAŞIMA KAPASİTESİ:** 120 kg

**AÇILIM TİPLERİ:** İkili hareketli kanat, dörtlü hareketli kanat, altılı hareketli kanat, sineklikli kanat.

**FRAME WIDTH:** 45 mm - 76 mm - 81 mm

**SASH WIDTH:** 28 mm - Sash without glazing molding

**SYSTEM WALL THICKNESS:** 1,2 mm

**GLASS THICKNESS:** 4, 6, 8, 16, 18, 20 mm

**SASH CARRY CAPACITY:** 120 kg

**OPENING TYPES:** Two moving sashes, four moving sashes, six moving sashes, sash with screen rail.



## SL32

**YALITIMSIZ  
SÜRME SİSTEMLER**  
UNINSULATED  
SLIDING SYSTEMS



TEKNİK KATALOG  
TECHNICAL CATALOG



MONTAJ KATALOĞU  
ASSEMBLY CATALOG

**KASA GENİŞLİĞİ:** 78 mm - 100 mm - 118 mm

**KANAT GENİŞLİĞİ:** 32 mm - Cam Çıtasız ve Cam Çıtalı Kanat

**SİSTEM ET KALINLIĞI:** 1,4 mm

**CAM KALINLIĞI:** 4, 5, 6, 8, 16, 18, 20, 22 mm

**KANAT TAŞIMA KAPASİTESİ:** 120 kg

**AÇILIM TİPLERİ:** İkili hareketli kanat, dörtlü hareketli kanat, altılı hareketli kanat, sineklikli kanat.

**FRAME WIDTH:** 78 mm - 100 mm - 118 mm

**SASH WIDTH:** 32 mm - Sash with and without glazing molding

**SYSTEM WALL THICKNESS:** 1,4 mm

**GLASS THICKNESS:** 4, 5, 6, 8, 16, 18, 20, 22 mm

**SASH CARRY CAPACITY:** 120 kg

**OPENING TYPES:** Two moving sashes, four moving sashes, six moving sashes, sash with screen rail.



# SL40

**YALITIMSIZ  
SÜRME SİSTEMLER**  
UNINSULATED  
SLIDING SYSTEMS



TEKNİK KATALOG  
TECHNICAL CATALOG



MONTAJ KATALOĞU  
ASSEMBLY CATALOG

**KASA GENİŞLİĞİ:** 79mm - 93mm - 115mm - 146mm

**KANAT GENİŞLİĞİ:** 42 mm - Cam Çıtasız ve Çıtalı Kanat

**SİSTEM ET KALINLIĞI:** 1,4 mm

**CAM KALINLIĞI:** 4 - 28 mm

**KANAT TAŞIMA KAPASİTESİ:** 160 kg

**AÇILIM TİPLERİ:** İkili hareketli kanat, dördü hareketli kanat, altılı hareketli kanat, kendinden sabit kanatlı kasa ile hareketli tek kanat, sineklikli kanat.

**FRAME WIDTH:** 79mm - 93mm - 115mm - 146mm

**SASH WIDTH:** 42 mm - Sash with and without glazing molding

**SYSTEM WALL THICKNESS:** 1,4 mm

**GLASS THICKNESS:** 4 - 28 mm

**SASH CARRY CAPACITY:** 160 kg

**OPENING TYPES:** Two moving sashes, four moving sashes, six moving sashes, self-fixed sash and single moving sash, sash with screen rail.

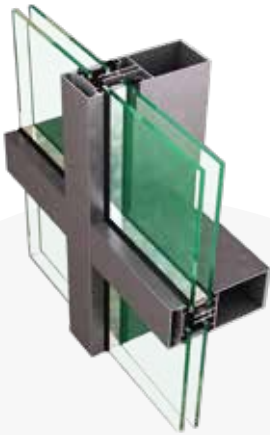

# FC50 AS

**GIYDİRME  
CEHPE SİSTEMİ**  
CURTAIN  
WALL SYSTEM



TEKNİK KATALOG  
TECHNICAL CATALOG

**DÜŞEY PROFİLLER / VERTICAL PROFILES:** 30, 50, 80, 90, 100, 120, 140, 146, 150, 166, 188, 210 mm

**YATAY PROFİLLER / HORIZONTAL PROFILES:** 36, 50, 65, 80, 106, 126, 156 mm

**SİSTEM ET KALINLIĞI / SYSTEM WALL THICKNESS:** 1,6 - 1,8 - 1,9 - 2 mm

**CAM KALINLIĞI / GLASS THICKNESS:** 6, 10, 13, 24, 28, 30, 32, 36, 40, 44, 48 mm

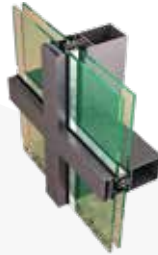

KAPAKLI CEPHE DETAYLARI (FC50-AS1)  
CURTAIN WALL SYSTEM DETAILS (FC50-AS1)



YARI KAPAKLI CEPHE DETAYLARI (FC50-AS2)  
SEMI COVER WALL SYSTEM DETAILS (FC50-AS2)



KASETLİ SİLİKON CEPHE DETAYLARI (FC50-AS3)  
STRUCTUREL SILICONE CURTAIN WALL  
SYSTEM DETAILS (FC50-AS3)

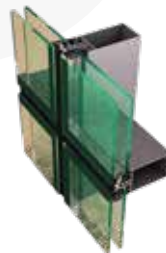

EKONOMİK SİLİKON CEPHE DETAYLARI (FC50-AS4)  
ECO STRUCTUREL SILICONE CURTAIN WALL  
SYSTEM DETAILS (FC50-AS4)



- Sistem kesit genişliği 42 mm
- Tek cam kullanımı ile ekonomiktir
- Cam arası Jaluzi seçeneği
- Alüminyum taşıyıcı düşey ve yatay profiller
- Sistem içi açılır cam kapı, ahşap kapı uygulama imkanı
- Klasik duvar bölme sistemleri ile kıyaslandığında çok daha hafif, ekonomik ve dekoratiftir
- Kolay montaj edilebilir

## INTERNO 42

### İÇ MEKAN SİSTEMLERİ

#### INTERIOR SYSTEMS



TEKNİK KATALOG  
TECHNICAL CATALOG



MONTAJ KATALOĞU  
ASSEMBLY CATALOG

- 42 mm system section width
- Economical with single glazing
- Integrated blind option
- Aluminum vertical and horizontal bearing profiles
- Opening glass door in the system, wooden door option
- Much lighter, more economical, and more decorative compared to classical wall partition systems
- Can be installed easily

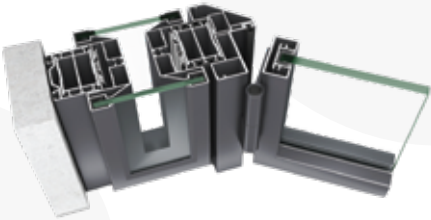

- Sistem kesit genişliği 85mm
- Çift cam kullanımına uygundur
- Ahşap panel uygulanabilir
- Dar profiller sayesinde şeffaf ve ferah ortamlar sağlar
- Sistem içi açılır cam kapı, ahşap kapı uygulama imkanı
- Kolay montaj edilebilir

## INTERNO 85

### İÇ MEKAN SİSTEMLERİ

#### INTERIOR SYSTEMS



TEKNİK KATALOG  
TECHNICAL CATALOG



MONTAJ KATALOĞU  
ASSEMBLY CATALOG

- 85mm system section width
- Suitable for double glazing use
- Wooden panel option
- Provides transparent and spacious environments thanks to narrow profiles
- Opening glass door in the system, wooden door option
- Can be installed easily



- Sistem kesit genişliği 100mm
- Çift cam kullanımına uygundur
- Isı izolasyonu
- Dar profiller sayesinde şeffaf ve ferah ortamlar sağlar
- Sistem içi açılır cam kapı, ahşap kapı uygulama imkanı
- Kolay montaj edilebilir

## INTERNO 100

### İÇ MEKAN SİSTEMLERİ

#### INTERIOR SYSTEMS



TEKNİK KATALOG  
TECHNICAL CATALOG



MONTAJ KATALOĞU  
ASSEMBLY CATALOG

- 100mm system section width
- Suitable for double glazing use
- Heat insulation
- Provides transparent and spacious environments thanks to narrow profiles
- Opening glass door in the system, wooden door option
- Can be installed easily

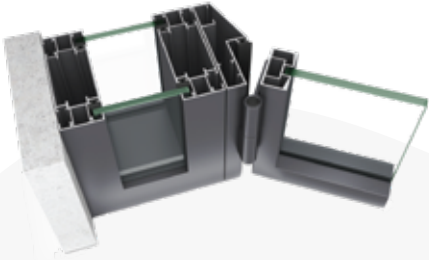

- Sistem kesit genişliği 100 mm
- Çift cam ve çift ahşap panel uygulama imkanı
- Alüminyum taşıyıcı düşey ve yatay profiller
- Sistem içi açılır cam kapı, ahşap kapı uygulama imkanı
- Klasik duvar bölme sistemleri ile kıyaslandığında çok daha hafif, ekonomik ve dekoratiftir
- Kolay montaj edilebilir

## INTERNO 100K

### İÇ MEKAN SİSTEMLERİ

#### INTERIOR SYSTEMS



TEKNİK KATALOG  
TECHNICAL CATALOG



MONTAJ KATALOĞU  
ASSEMBLY CATALOG

- 100mm system section width
- Double glazing and double wooden panel option
- Aluminum vertical and horizontal bearing profiles
- Opening glass door in the system, wooden door option
- Much lighter, more economical, and more decorative compared to classical wall partition systems
- Can be installed easily



- Çeşitli duvar kalınlıklarına uygun alüminyum ayarlanabilir kasa ile cam, ahşap ve alüminyum kapı uygulanabilir
- Dekoratif kapı kasa tasarım seçenekleri
- 100mm ile 225mm arasında ki duvar genişliklerine uyumlu kasa seçenekleri
- Kolay montaj edilebilir

## INTERNO DOOR

### İÇ MEKAN SİSTEMLERİ

#### INTERIOR SYSTEMS



TEKNİK KATALOG  
TECHNICAL CATALOG



MONTAJ KATALOĞU  
ASSEMBLY CATALOG

- Option to use glass, wooden, and aluminum door thanks to aluminum frame adjustable to various wall thicknesses
- Decorative door frame design options
- Frame options compatible with wall widths between 100mm and 225mm
- Can be installed easily



## FDT62

### KATLANIR KAPI SİSTEMLERİ

#### FOLDING DOOR SYSTEMS



TEKNİK KATALOG  
TECHNICAL CATALOG



MONTAJ KATALOĞU  
ASSEMBLY CATALOG

**KASA GENİŞLİĞİ:** 62 mm

**KANAT GENİŞLİĞİ:** 62 mm

**SİSTEM ET KALINLIĞI:** 1,6 mm

**ISI BARIYERİ:** 20 mm  **Kasa - Kanat (UF)** 3,62 W(M<sup>2</sup>.K)

**CAM KALINLIĞI:** 5 - 40 mm

**AKSESUAR SEÇİMİ:** Sisteme özel üstten asma ray sistemi ve menteşe grubu.

**AÇILIM TİPLERİ:** 3 kanat, 3+1 kanat, 3+3 kanat, 5 kanat, 5+1 kanat, 7 kanat, 7+1 kanat açılımları.

**FRAME WIDTH:** 62 mm

**SASH WIDTH:** 62 mm

**SYSTEM WALL THICKNESS:** 1,6 mm

**INSULATION BARRIER:** 20 mm

**GLASS THICKNESS:** 5 - 40 mm  **Frame - Sash (UF)** 3,62 W(M<sup>2</sup>.K)

**ACCESSORY SELECTION:** Top rail system and hinge assembly specific to the system.

**OPENING TYPES:** Folding door opening types: 3 sashes, 3+1 sashes, 3+3 sashes, 5 sashes, 5+1 sashes, 7 sashes, 7+1 sashes





# AB40

## CAM SÜRME SİSTEMLER

### GLASS SLIDING SYSTEMS

- 8, 10 mm cam yapabilme.
- Ergonomik ve ekonomiktir.
- Kısmen ısı geçişini azaltır ve hava geçişini minimize eder.
- Maximum yükseklik 2,3 mt. kadar yapılabilir.



TEKNİK KATALOG  
TECHNICAL CATALOG



MONTAJ KATALOĞU  
ASSEMBLY CATALOG

- 8, 10 mm glass options.
- Ergonomic and economical
- Partially reduces heat transfer and minimizes air transfer.
- Maximum height 2,3 mt. can be done up.



# AB40T

## CAM SÜRME SİSTEMLER

### GLASS SLIDING SYSTEMS

- 30 mm. boşluğa göre ısı cam yapabilme.
- Ergonomik ve ekonomiktir.
- Epdm fitiller ile ısı geçişi azaltır ve hava geçişini minimize eder.
- Maximum yükseklik 2,3 mt. kadar yapılabilir.
- İspanyolet kol ile 2 noktadan kilitleme sağlar.



TEKNİK KATALOG  
TECHNICAL CATALOG



MONTAJ KATALOĞU  
ASSEMBLY CATALOG

- Double glazing option up to 30 mm.
- Ergonomic and economical.
- With Epdm gaskets, it reduces the heat transfer and minimizes the air transfer.
- Maximum height 2,3 mt. can be done up.
- It provides 2-point locking with espagnolette arm.



# AB100

## CAM SÜRME SİSTEMLER

### GLASS SLIDING SYSTEMS



TEKNİK KATALOG  
TECHNICAL CATALOG



MONTAJ KATALOĞU  
ASSEMBLY CATALOG

- 8,10 mm cam yapabilme
- 3 ray ve 5 ray seçenekleri ile istediğiniz cam kanat adetleri yapabilme.
- Kolay uygulanabilir ve ekonomiktir.
- Kısmen ısı geçisini azaltır ve hava geçisini minimize eder.
- Max yükseklik 2,5mt. max kanat genişliği 1 metredir.
- Eşikli kasa ve eşiksiz olarak uygulanabilir.

- 8, 10 mm glass option
- 3 rail and 5 rail options to make any glass sash you want.
- Easily applicable and economical.
- Partially reduces heat transfer and minimizes air transfer.
- Max height 2,5mt. max sash width is 1mt.
- It can be applied as thresholded frame and without threshold.



# AB160

## CAM SÜRME SİSTEMLER

### GLASS SLIDING SYSTEMS



TEKNİK KATALOG  
TECHNICAL CATALOG

- 10 mm cam yapabilme
- 3 ray, 4 ray, 5 ray, 6 ray seçenekleri ile istediğiniz cam kanat adetleri yapabilme.
- Kolay uygulanabilir ve ekonomiktir.
- Kısmen ısı geçisini azaltır ve hava geçisini minimize eder.
- Max yükseklik 2,5mt. max kanat genişliği 1 metredir.

- 10 mm glass option
- 3 rail, 4 rail, 5 rail, 6 rail options to make any glass sash you want.
- Easily applicable and economical.
- Partially reduces heat transfer and minimizes air transfer.
- Max height 2,5mt. max sash width is 1mt.



- Tak cam (8 mm)
- Geniş açıklıklara uyumlu (H.max 3200mm W.max . 2800mm)
- Ekonomik
- A6 Zincir Mekanizması
- İthal Motor

## G100

### GİYOTİN SÜRME CAM BALKON SİSTEMİ

VERTICAL SLIDING GLASS BALCONY SYSTEM

- Single glass (8 mm)
- Compatible for large opening (H.max 3200mm W.max 2800mm)
- Economic
- A6 Chain Mechanism
- Imported Motor



TEKNİK KATALOG  
TECHNICAL CATALOG



MONTAJ KATALOĞU  
ASSEMBLY CATALOG



- Isıcam (8 - 24 mm)
- Geniş açıklıklara uyumlu (H.max 3000mm W.max . 2800mm)
- A8 Zincir Mekanizması
- İthal Motor

## G100T

### ISICAMLI GİYOTİN SÜRME CAM BALKON SİSTEMİ

VERTICAL SLIDING GLASS BALCONY SYSTEM WITH THERMAL GLASS

- Double glass (8 - 24 mm)
- Compatible for large opening (H.max 3000mm W.max 2800mm)
- A8 Chain Mechanism
- Imported Motor



TEKNİK KATALOG  
TECHNICAL CATALOG



MONTAJ KATALOĞU  
ASSEMBLY CATALOG



## PR120

### PERGOLA VE GÖLGELENDİRME SİSTEMİ PERGOLA SYSTEM



TEKNİK KATALOG  
TECHNICAL CATALOG

- Sabit menfez, perde, güneş kırıcı, polikarbon yapabilme
- Dekotarif Ayak
- Boyalı Aksesuar

- Stable grill, curtain, sunbreaker, capable of polycarbonate
- Decorative columns
- Painted Accessories



## PR110

### PERGOLA SİSTEMİ

PERGOLA SYSTEM



TEKNİK KATALOG  
TECHNICAL CATALOG

- Su tahliyesi için geniş oluk
- 110 mm düşey ayak
- Takviyeli taşıyıcı seçeneği
- 10mm - 24mm cam boşluğu
- Çelik takviye kullanım opsiyonu

- Wide gutter for water drainage
- Vertical columns
- Supported carrier option
- Glass gap
- Option for using steel supported



## PR140

### PERGOLA SİSTEMİ

PERGOLA SYSTEM



TEKNİK KATALOG  
TECHNICAL CATALOG

- Su tahliye için geniş oluk
- 140 mm düşey ayak
- 8mm - 28mm cam boşluğu
- Çelik takviye kullanım opsiyonu

- Wide gutter for water drainage
- 140mm vertical columns
- 8mm - 28mm glass gap
- Option for using steel supported



## PR141

### PERGOLA SİSTEMİ

PERGOLA SYSTEM



TEKNİK KATALOG  
TECHNICAL CATALOG

- Su tahliye için geniş oluk
- 140 mm oval ve düz ayak
- 8mm - 28mm cam boşluğu
- Çelik takviye kullanım opsiyonu
- Düz, oval, dekoratif, oluk görünüm opsiyonu

- Wide gutter for water drainage
- 140mm oval and straight columns
- 8mm - 28mm glass gap
- Option for using steel supported
- Straight, oval, decorative, gutter option



## PR125

### BİOKLİMATİK PERGOLA SİSTEMİ

MOVING  
PERGOLA SYSTEM



TEKNİK KATALOG  
TECHNICAL CATALOG

- 8 - 24 mm cam
- Geniş Açıklıklara Uyumlu (HMax 3000 Wmax 4500)
- A8 Zincir Mekanizması
- İthal Motor

- 8 - 24 mm glass
- Compatible for large opening (Hmax 3000 Wmax 4500)
- A8 Chain Mechanism
- Imported Motor



## R800

### KÜPEŞTE KORKULUK SİSTEMİ

RAILING SYSTEM



TEKNİK KATALOG  
TECHNICAL CATALOG

- Yuvarlak küpeşte
- Kare küpeşte
- Baza küpeşte

- Round handrail
- Square handrail
- Glass handrail



- 80 x 80 düşey dikmesi ile düz veya 90° açı yapabilme
- Dar kapılar ya da AS42 sistemle uyumlu
- Lambri ya da kutu pratik kullanımı

## ALUFENS80

### ÇİT SİSTEMİ

FENCE  
SYSTEMS



TEKNİK KATALOG  
TECHNICAL CATALOG

- Capability to make straight or 90 degree angles
- Compatible with narrow AS42 system
- Use of profile panelling



**KASA GENİŞLİĞİ:** 55 mm

**KANAT GENİŞLİĞİ:** 63 mm

**SİSTEM ET KALINLIĞI:** 1,5 - 1,8 mm

**AKSESUAR SEÇİMİ:** Euro norm kanallı profiller

**AÇILIM TİPLERİ:** Tek kanat pencere çift kanat pencere, 3+0 / 2+1 / 3+1 katlanır pencere.

## P55

### KANATLI AÇILIR PANJUR SİSTEMİ

VENTED OPENING  
SHUTTER SYSTEM

**FRAME WIDTH:** 55 mm

**SASH WIDTH:** 63 mm

**SYSTEM WALL THICKNESS:** 1,5 - 1,8 mm

**ACCESSORY SELECTION:** Profiles with Euronorm channels.

**OPENING TYPES:** Single sash window, double sash, 3+0 / 2+1 / 3+1 folding sash.



TEKNİK KATALOG  
TECHNICAL CATALOG



MONTAJ KATALOĞU  
ASSEMBLY CATALOG



- Zip perde
- Mono blok üst kasa
- İthal motor
- Özel tasarım

# Z30

**ZIP PERDE  
SİSTEMİ**

ZIP CURTAIN  
SYSTEM



TEKNİK KATALOG  
TECHNICAL CATALOG

- Zip blinds
- Monoblock top frame
- Imported motor
- Special design





# Asistal Artırılmış Gerçeklik Katalođu

Asistal AR uygulamasını App Store ve Google Play üzerinden indirin ve ürünleri istediđiniz açıdan görebileceđiniz sanal gerçekliđi yaşıyın.

## Asistal Augmented Reality Catalog

Download the Asistal AR application via App Store or Google Play and experience virtual reality which allows you to see the products from any angle.

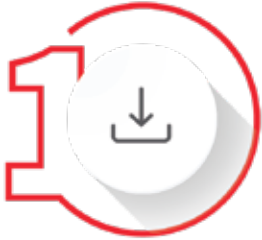

### İNDİRİN

Akıllı telefon veya tabletinizde yer alan App Store veya Google Play üzerinden **ASİSTAL AR** uygulamasını indirin.

### DOWNLOAD

Download the **ASİSTAL AR** application via App Store or Google Play to your smartphone or tablet.



### YAKLAŞTIRIN

Yanında AR logosu bulunan ürünün olduđu sayfaya kameranızı yaklaştıyın.

### ZOOM IN

Bring your camera closer to the page with a product that has the AR logo next to it.



### İNCELEYİN

ASİSTAL tarafından geliştirilen sisteme ait 3D görüntü ekranda belirecektir. Ekran üzerinde kaydırma yaparak 3D görüntüyü döndürüp her açıdan görüntüleyebilirsiniz.

### VIEW

The 3D image of the system developed by Asistal will appear on the screen. You can rotate and view the 3D image from any angle by scrolling the screen.



# AS42

## YALITIMSIZ KAPI & PENCERE SİSTEMLERİ

## UNINSULATED DOOR AND WINDOW SYSTEMS

**Kasa Geniřliđi** 42 mm  
**Frame Width**

**Kanat Geniřliđi** 44 mm  
**Sash Width**

**Sistem Et Kalınlıđı** 1.2 mm  
**Thickness**

**Cam Kalınlıđı** 4-24 mm  
**Glazing**

**Aksesuar Seđimi** Euro norm kanallı profiller, PVC aksesuarlarına uygun profiller (Multi Point Lock)

**Groove Types** Euro Norm Groove / PVC Groove

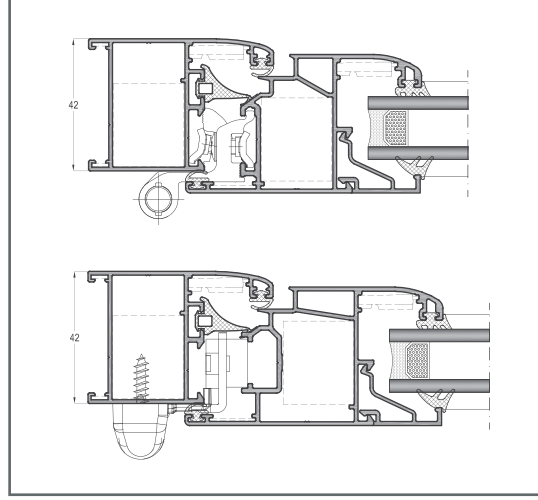
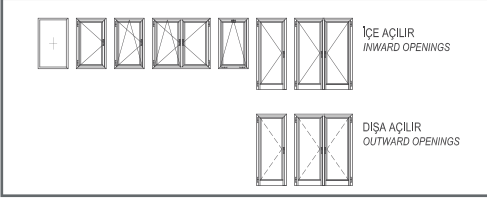

# C55

## YALITIMSIZ KAPI & PENCERE SİSTEMLERİ

## UNINSULATED DOOR AND WINDOW SYSTEMS

**Kasa Geniřliđi** 55 mm  
**Frame Width**

**Kanat Geniřliđi** 58 mm  
**Sash Width**

**Sistem Et Kalınlıđı** 1.8 mm  
**Thickness**

**Cam Kalınlıđı** 4-40 mm  
**Glazing**

**Aksesuar Seđimi** Euro norm kanallı profiller, PVC aksesuarlarına uygun profiller (Multi Point Lock)

**Groove Types** Euro Norm Groove / PVC Groove

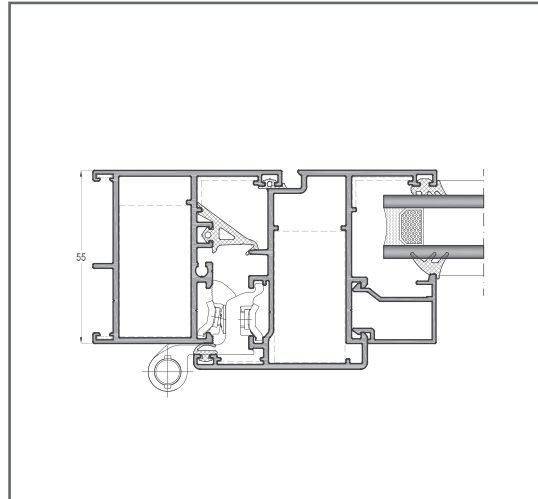
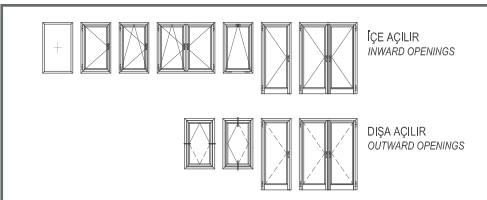

# TE56

## YALITIMLI KAPI & PENCERE SİSTEMLERİ

## INSULATED DOOR AND WINDOW SYSTEMS

**Kasa Geniřliđi** 56 mm  
**Frame Width**

**Kanat Geniřliđi** 59 mm  
**Sash Width**

**Sistem Et Kalınlıđı** 1.3 mm  
**Thickness**

**Isı Bariyeri** 18 mm  
**Thermal Break**

**Cam Kalınlıđı** 4 - 38 mm  
**Glazing**

**Isı Geçirgenlik Katsayısı**  $U_f=3,28 \text{ W/m}^2\text{K}$   
**Glazing**

**Aksesuar Seçimi** Euro norm kanallı profiller, PVC aksesuarlarına uygun profiller (Multi Point Lock)

**Groove Types** Euro Norm Groove / PVC Groove

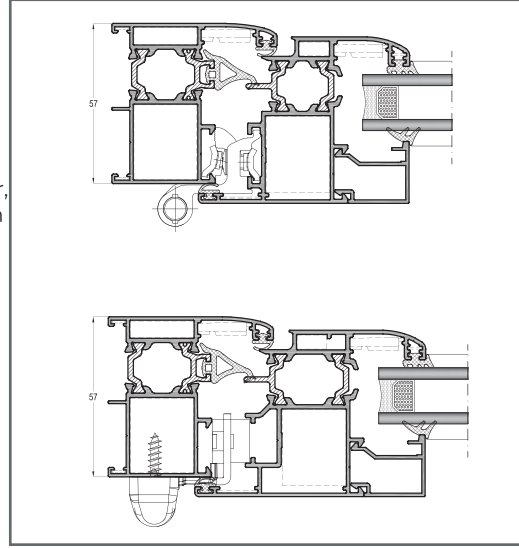
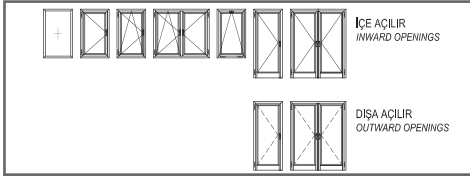

# TH55

## YALITIMLI KAPI & PENCERE SİSTEMLERİ

## INSULATED DOOR AND WINDOW SYSTEMS

**Kasa Geniřliđi** 55 mm  
**Frame Width**

**Kanat Geniřliđi** 59 mm  
**Sash Width**

**Sistem Et Kalınlıđı** 1.8 mm  
**Thickness**

**Isı Bariyeri** 14,8 mm  
**Thermal Break**

**Cam Kalınlıđı** 4 - 40 mm  
**Glazing**

**Isı Geçirgenlik Katsayısı**  $U_f=3,25 \text{ W/m}^2\text{K}$   
**Glazing**

**Aksesuar Seçimi** Euro norm kanallı profiller, PVC aksesuarlarına uygun profiller (Multi Point Lock)

**Groove Types** Euro Norm Groove / PVC Groove

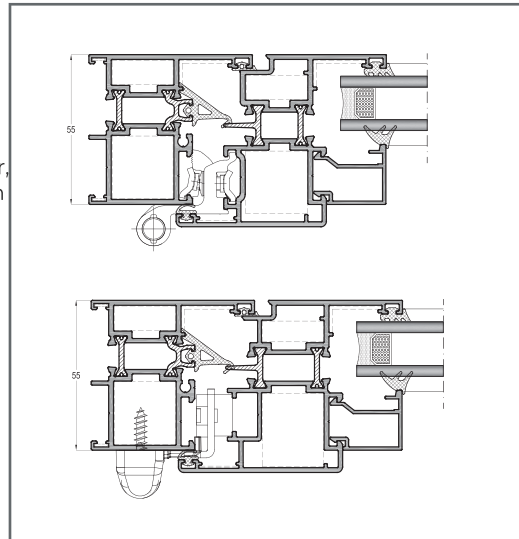
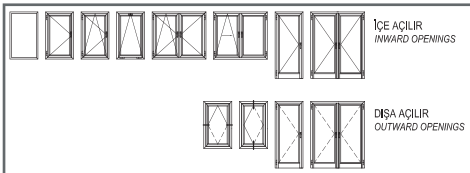

# TH62

## YALITIMLI KAPI & PENCERE SİSTEMLERİ

## INSULATED DOOR AND WINDOW SYSTEMS

**Kasa Geniřliđi** 62 mm  
**Frame Width**

**Kanat Geniřliđi** 65 mm  
**Sash Width**

**Sistem Et Kalınlıđı** 1.8 mm  
**Thickness**

**Isı Bariyeri** 18 mm  
**Thermal Break**

**Cam Kalınlıđı** 10 - 45 mm  
**Glazing**

**Isı Geçirgenlik Katsayısı**  $U_f=2,71 \text{ W/m}^2\text{K}$   
**Glazing**

**Aksesuar Seçimi** Euro norm kanallı profiller,  
PVC aksesuarlarına uygun  
profiller  
(Multi Point Lock)

**Groove Types** Euro Norm Groove / PVC  
Groove

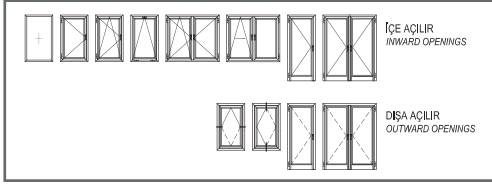
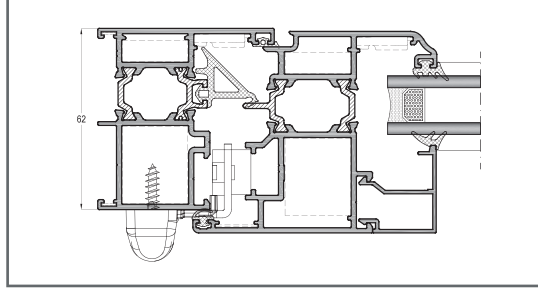

# THS62

## YALITIMLI KAPI & PENCERE SİSTEMLERİ

## INSULATED DOOR AND WINDOW SYSTEMS

**Kasa Geniřliđi** 62 mm  
**Frame Width**

**Kanat Geniřliđi** 65 mm  
**Sash Width**

**Sistem Et Kalınlıđı** 1.8 mm  
**Thickness**

**Isı Bariyeri** 18 mm  
**Thermal Break**

**Cam Kalınlıđı** 10 - 45 mm  
**Glazing**

**Isı Geçirgenlik Katsayısı**  $U_f=2,71 \text{ W/m}^2\text{K}$   
**Glazing**

**Aksesuar Seçimi** Euro norm kanallı profiller,  
PVC aksesuarlarına uygun  
profiller  
(Multi Point Lock)

**Groove Types** Euro Norm Groove / PVC  
Groove

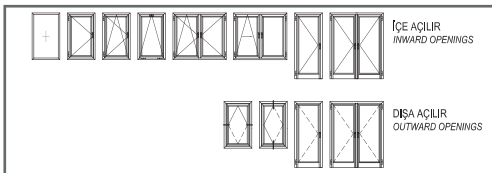
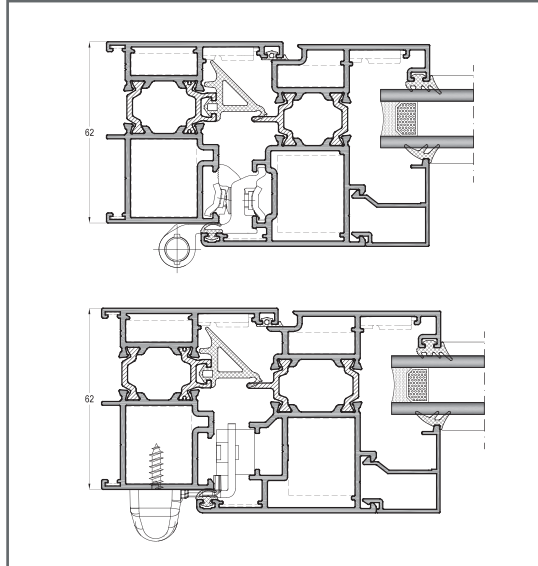

# THS68

## YALITIMLI KAPI & PENCERE SİSTEMLERİ

## INSULATED DOOR AND WINDOW SYSTEMS

<b>Kasa Geniřliđi</b> Frame Width	68 mm
<b>Kanat Geniřliđi</b> Sash Width	71 mm
<b>Sistem Et Kalınlıđı</b> Thickness	1.8 mm
<b>Isı Bariyeri</b> Thermal Break	24 mm
<b>Cam Kalınlıđı</b> Glazing	16 - 52 mm
<b>Isı Geçirgenlik Katsayısı</b> Glazing	Uf=2,52 W/m <sup>2</sup> K
<b>Aksesuar Seçimi</b>	Euro norm kanallı profiller, PVC aksesuarlarına uygun profiller (Multi Point Lock)
<b>Groove Types</b>	Euro Norm Groove / PVC Groove

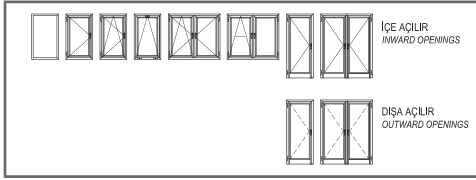
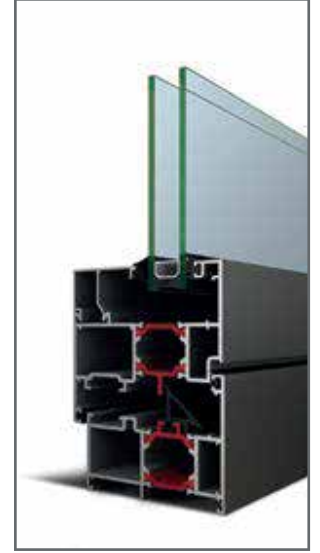
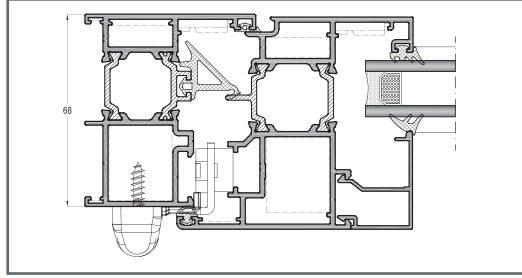

# THS78

## YALITIMLI KAPI & PENCERE SİSTEMLERİ

## INSULATED DOOR AND WINDOW SYSTEMS

<b>Kasa Geniřliđi</b> Frame Width	78 mm
<b>Kanat Geniřliđi</b> Sash Width	81 mm
<b>Sistem Et Kalınlıđı</b> Thickness	1.8 mm
<b>Isı Bariyeri</b> Thermal Break	34 mm
<b>Cam Kalınlıđı</b> Glazing	20 - 36 mm
<b>Isı Geçirgenlik Katsayısı</b> Glazing	Uf=1,66 - 1,98 W/m <sup>2</sup> K
<b>Aksesuar Seçimi</b>	Euro norm kanallı profiller, PVC aksesuarlarına uygun profiller (Multi Point Lock)
<b>Groove Types</b>	Euro Norm Groove / PVC Groove

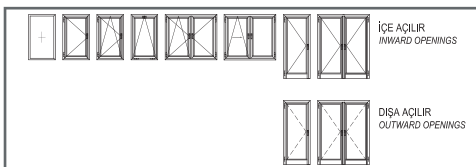
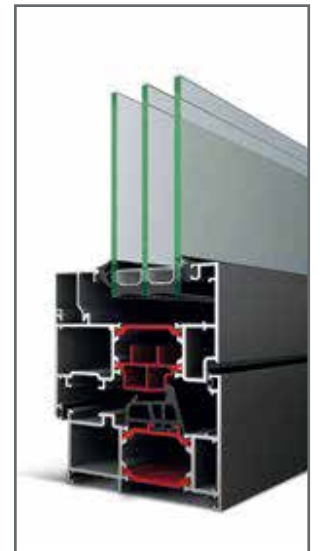
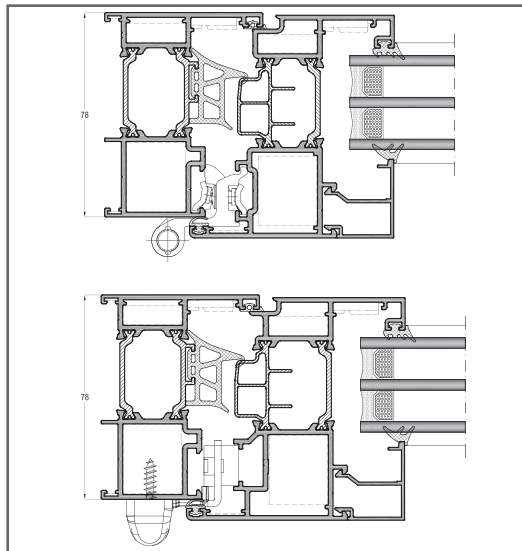

# TH62-HV

## YALITIMLI KAPI & PENCERE SİSTEMLERİ

## INSULATED DOOR AND WINDOW SYSTEMS

**Kasa Geniřliđi** 62 mm  
**Frame Width**

**Kanat Geniřliđi** 65 mm  
**Sash Width**

**Sistem Et Kalınlıđı** 1.8 mm  
**Thickness**

**Isı Bariyeri** 18 mm  
**Thermal Break**

**Cam Kalınlıđı** 24 mm  
**Glazing**

**Isı Geçirgenlik Katsayısı**  $U_f=2,98 \text{ W/m}^2\text{K}$   
**Glazing**

**Aksesuar Seçimi** Euro norm kanallı profiller,  
**Groove Types** Euro Norm Groove

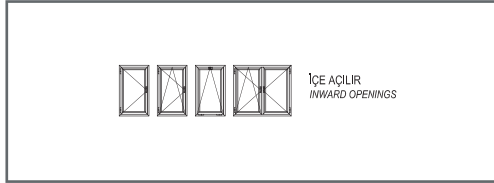
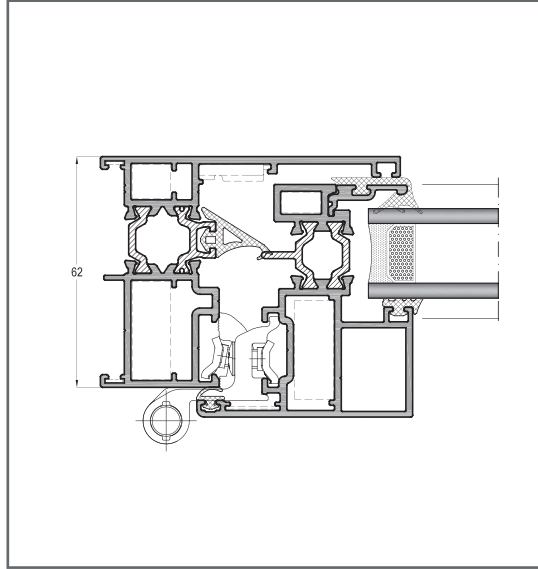

# SL28

## YALITIMSIZ SÜRME SİSTEMLER

## UNINSULATED SLIDING SYSTEMS

**Kasa Geniřliđi** 45 mm - 76 mm - 81 mm  
**Frame Width**

**Kanat Geniřliđi** 28 mm - Cam Çıtasız Kanat  
**Sash Width**

**Sistem Et Kalınlıđı** 1.2 mm  
**Thickness**

**Cam Kalınlıđı** 24 mm  
**Glazing**

**Açılım Tipleri** İkili kanat, üçlü kanat, dördü kanat, altılı kanat, sineklikli kanat.

**Opening Types** 2, 3, 4 and 6 sliding sashes, flyscreen sash.

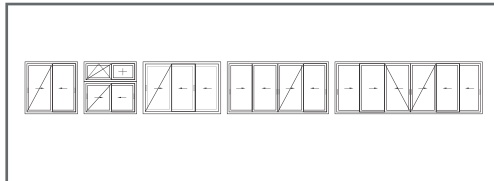
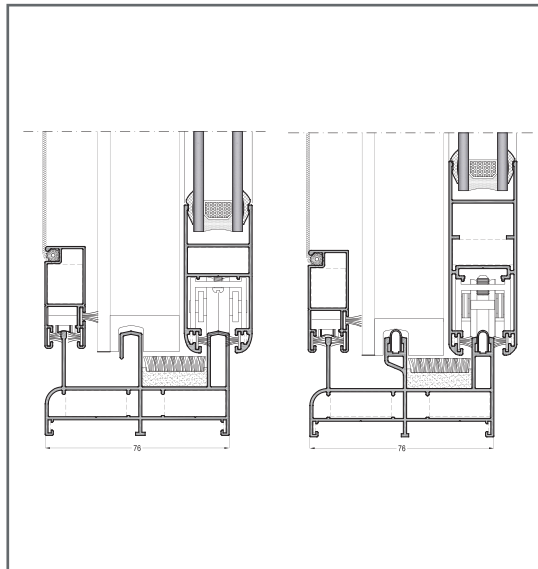

# SL40T

## YALITIMLI SÜRME SİSTEMLER

## INSULATED SLIDING SYSTEMS

<b>Kasa Geniřliđi</b> Frame Width	93 mm - 115 mm - 146 mm
<b>Kanat Geniřliđi</b> Sash Width	42 mm
<b>Sistem Et Kalınlıđı</b> Thickness	1.4 mm
<b>Isı Bariyeri</b> Thermal Break	Kasa: 18mm - Kanat:14,8mm
<b>Cam Kalınlıđı</b> Glazing	4, 5, 6, 8, 16, 18, 20, 22 mm
<b>Açılım Tipleri</b>	İkili kanat, üçlü kanat, dörtlü kanat, altılı kanat, kendinden sabit kanatlı kasa ile hareketli tek kanat, sineklikli kanat.
<b>Opening Types</b>	2, 3, 4 and 6 sliding sashes, flyscreen sash, 1 sliding 1 fixed sash frame.

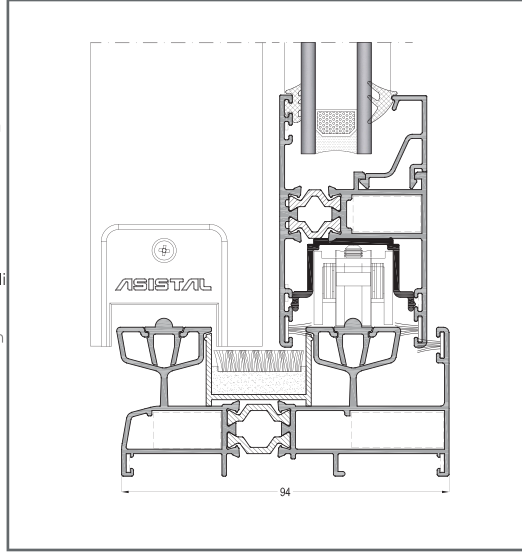
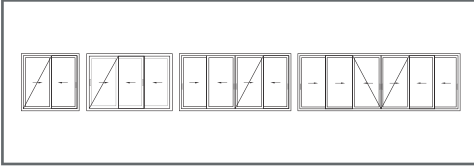

# SL38T-K

## YALITIMLI SÜRME SİSTEMLER

## INSULATED SLIDING SYSTEMS

<b>Kasa Geniřliđi</b> Frame Width	87,5 mm - 94 mm - 107 mm
<b>Kanat Geniřliđi</b> Sash Width	38 mm - Cam Çıtasız ve Cam Çıtalı Kanat
<b>Sistem Et Kalınlıđı</b> Thickness	1.4 mm
<b>Isı Bariyeri</b> Thermal Break	Kasa: 24 mm - Kanat: 20 mm
<b>Cam Kalınlıđı</b> Glazing	4, 5, 6, 8, 16, 20, 22, 24 mm
<b>Kanat Tařıma Kapasitesi</b> Sash Carry Capacity	200 kg
<b>Max Kanat Eni</b> Max Sash Width	650 mm - 2000 mm
<b>Max Kanat Yüksekliđi</b> Max Sash Height	1200 mm - 2400 mm

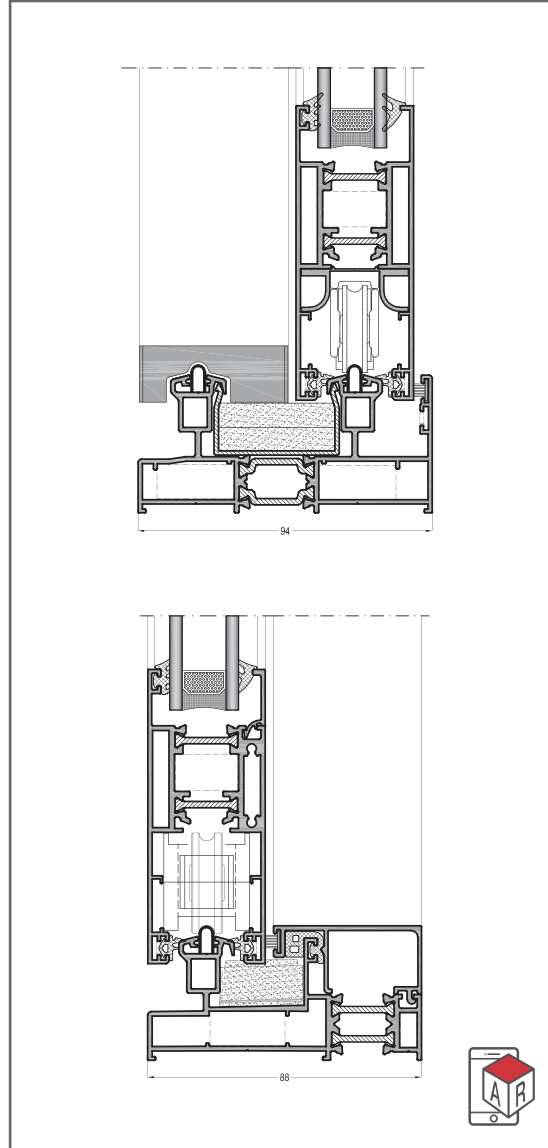
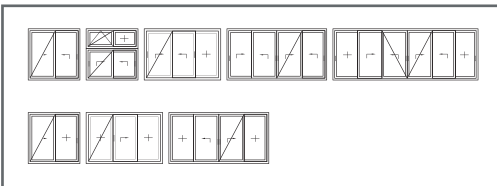



# SL38T-N

## YALITIMLI SÜRME SİSTEMLER

## INSULATED SLIDING SYSTEMS

**Kasa Geniřliđi** 87,5 mm - 94 mm - 107 mm - 144 mm  
**Frame Width**

**Kanat Geniřliđi** 38 mm - Cam Çıtasız ve Cam Çıtalı Kanat  
**Sash Width**

**Sistem Et Kalınlıđı** 1.4 mm  
**Thickness**

**Isı Bariyeri** Kasa: 24 mm - Kanat: 20 mm  
**Thermal Break**

**Cam Kalınlıđı** 4, 5, 6, 8, 16, 18, 20, 22, 24 mm  
**Glazing**

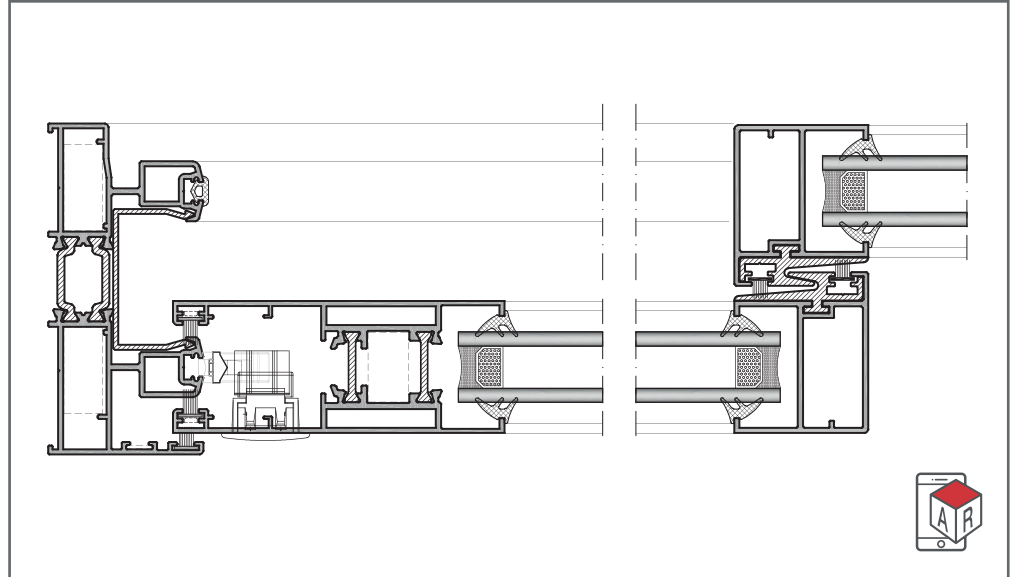
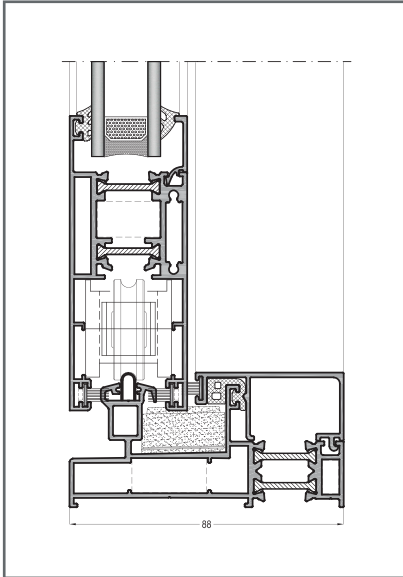
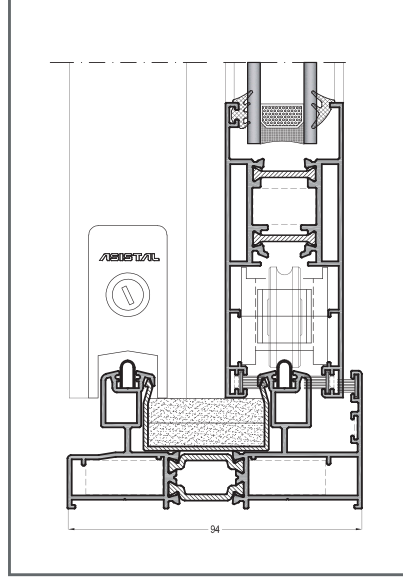
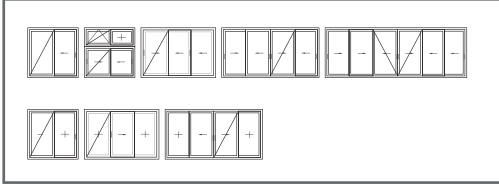

# LS60

## YALITIMLI SÜRME SİSTEMLER

## INSULATED SLIDING SYSTEMS

**Kasa Geniřliđi** 69 mm - 136 mm - 145 mm - 221 mm  
**Frame Width**

**Kanat Geniřliđi** 60 mm  
**Sash Width**

**Sistem Et Kalınlıđı** 1.8 mm  
**Thickness**

**Isı Bariyeri** Kasa: 24 mm - Kanat: 14,8 mm  
**Thermal Break**

**Cam Kalınlıđı** 10 - 46 mm  
**Glazing**

**Kanat Tařıma Kapasitesi** 200 kg - 400 kg  
**Sash Carry Capacity**

**Max Kanat Eni** 720 mm - 3235 mm  
**Max Sash Width**

**Max Kanat Yüklüklüđi** 1200 mm - 2700 mm ilave parça ile 3300 mm

**Max Sash Height** 1200 mm - 2700 mm with additional part 3300 mm

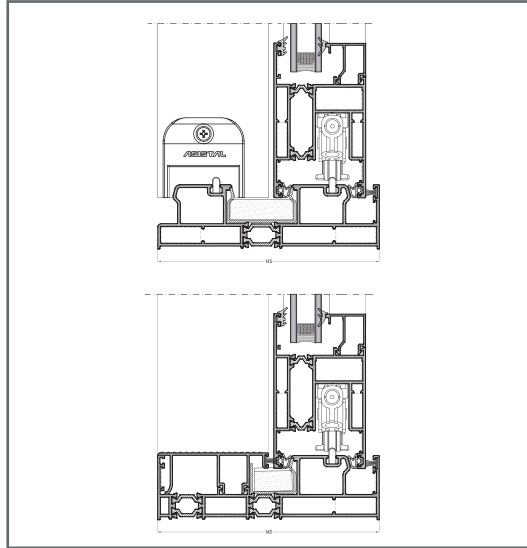
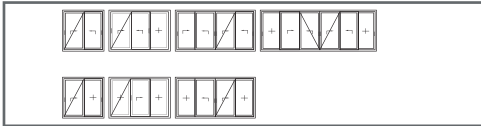

# FDT62

## YALITIMLI SÜRME SİSTEMLER

## INSULATED SLIDING SYSTEMS

**Kasa Geniřliđi** 62 mm  
**Frame Width**

**Kanat Geniřliđi** 62 mm  
**Sash Width**

**Sistem Et Kalınlıđı** 1.6 mm  
**Thickness**

**Isı Bariyeri** 20 mm  
**Thermal Break**

**Cam Kalınlıđı** 4 - 40 mm  
**Glazing**

**Aksesuar Seçimi** Sisteme özel kol, kilitleme ve menteře grubu

**Accessory Selection** Special hinges, handles and locking

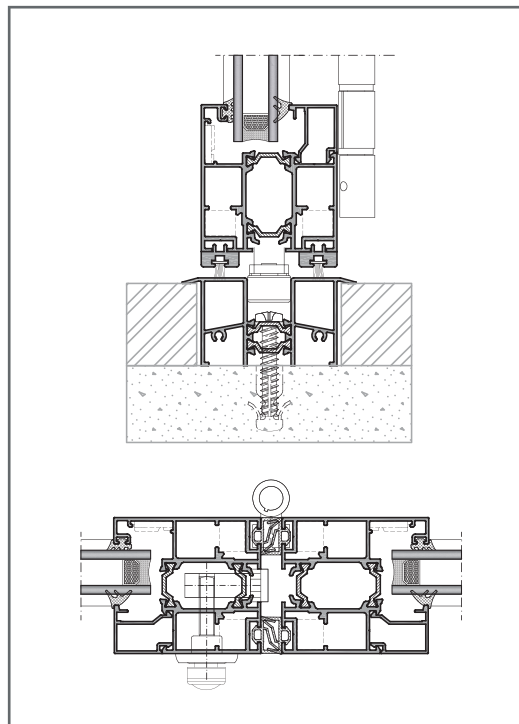
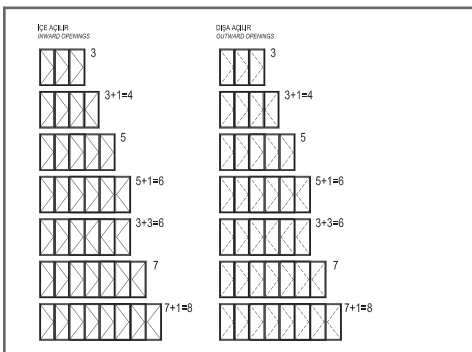

# FC50 AS

## GIYDIRME CEHPE SİSTEMİ

## CURTAIN WALL SYSTEM

**Düsey Profiller** 30, 50, 80, 90, 100, 120, 140, 146, 150,  
Mullion Profiles 166, 188, 210 mm

**Yatay Profiller** 35, 50, 60, 65, 80, 105, 125, 155 mm  
Transom Profiles

**Sistem Et Kalınlığı** 1,6 mm - 1,9 mm  
Thickness

**Cam Kalınlığı** 6 mm - 52 mm  
Glazing

**Isı Geçirgenlik Katsayısı**  $U_f = \min 2,13 \text{ W/m}^2$   
Cam Kalınlıklarına Bağlı

**Uf Value** According to the  
glass thickness

**FC50 - AS 1** Kapaklı Cephe  
Curtain Wall

**FC50 - AS 2** Yarı Kapaklı Cephe  
Semi Cover Curtain Wall

**FC50 - AS 3** Kasetli Silikon Cephe  
Structural Silicone

**FC50 - AS 4** Ekonomik Silikon Cephe  
Eco Structural Silicone

**FC50 - AS 5** Cam İçi Çıtalı Silikon Cephe  
4 Side Structural Silicone

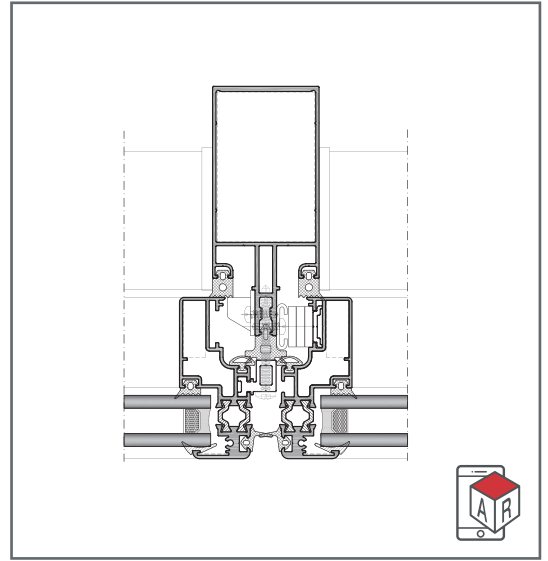
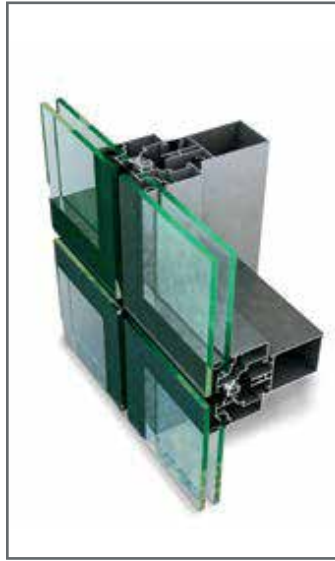
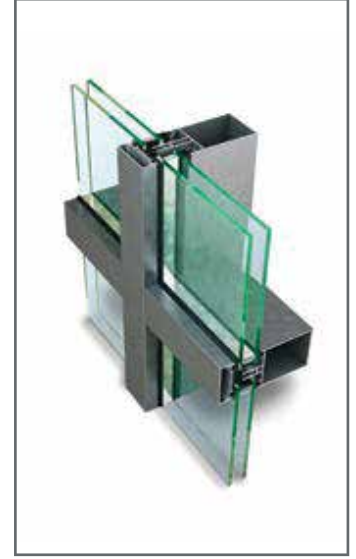
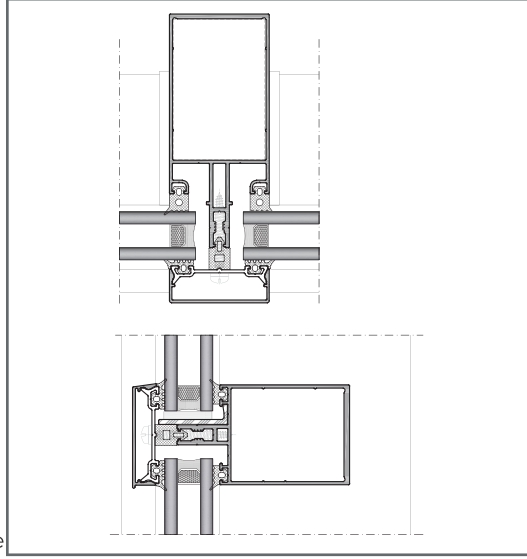

# INTERNO 42

İÇ MEKAN SİSTEMLERİ  
INTERIOR SYSTEMS

Sistem Kasa Geniřliđi 42 mm  
Frame Width

Cam Kalınlıđı 8 - 10 mm  
Glazing

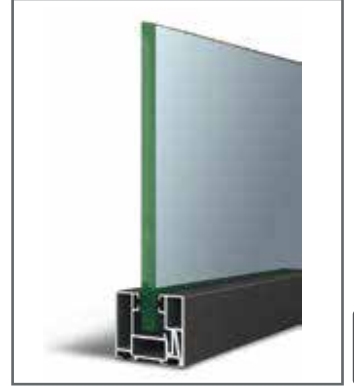
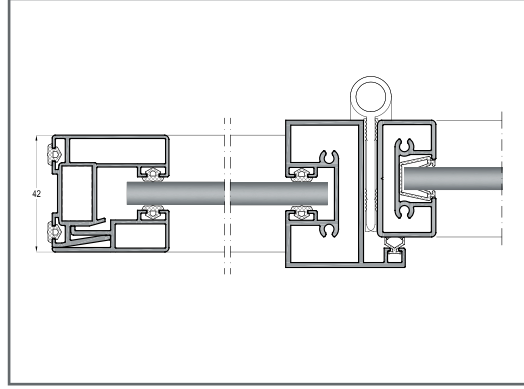

# INTERNO KAPI

İÇ MEKAN SİSTEMLERİ  
INTERIOR SYSTEMS

Sistem Pervaz Geniřliđi  
System Sill Width

Standart Seri 68 mm  
Standart Serial

Dekoratif Pervazlı Seri 68 mm  
Decorative Serial

Dar Pervazlı Seri 40 mm  
Narrow Serial

Geniř Pervazlı Seri 80 mm  
Wide Serial

Düz Pervazlı Seri 55 mm  
Flat Serial

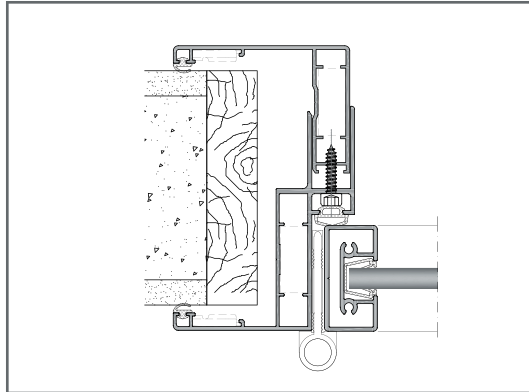

Duvar Kalınlıđı  
Wall Thickness

Standart Seri 110 - 240 mm  
Standart Serial

Dekoratif Pervazlı Seri 105 - 240 mm  
Decorative Serial

Dar Pervazlı Seri 95 - 300 mm  
Narrow Serial

Geniř Pervazlı Seri 200 - 310 mm  
Wide Serial

Düz Pervazlı Seri 95 - 210 mm  
Flat Serial

## MERKEZ FABRİKA

- +90 (288) 263 44 15
- +90 (288) 263 43 36
- satis@asistal.com
- export@asistal.com
- proje@asistal.com
- Kırklareli OSB No:2  
Cad:2 Kırklareli / TÜRKİYE

## MERKEZ ÇORLU

- +90 (282) 652 50 96
- +90 (282) 652 56 76
- info@asistal.com
- Hatip Mah. Ali Osman Çelebi  
Bulvarı No:54  
Çorlu – Tekirdağ / Türkiye

## İSTANBUL BÖLGE MÜDÜRLÜĞÜ

- +90 (212) 654 65 23
- +90 (212) 654 65 24
- +90 (212) 654 65 26
- istanbul@asistal.com
- Prof. Dr. Nevzat Pisak Cad.  
Doğu San. Sit. 8. Blok No:3  
Yenibosna – İstanbul / Türkiye

## ANKARA BÖLGE MÜDÜRLÜĞÜ

- +90 (312) 348 10 13
- +90 (312) 348 10 14
- ankara@asistal.com
- Önder Mah. Sırma Sokak  
No:49 06080 Altındağ  
Siteler – Ankara / Türkiye

## ASSIST ALUMINIUM INC.

- 973-400-5500
- us@asistal.com
- 1605 John Street Suite 106  
Fort Lee, 07024  
New Jersey / United States

## ÇORLU YENİ SANAYİ ŞUBE

- +90 (282) 673 69 71
- +90 (282) 673 69 06
- corlusanayi@asistal.com
- Yeni San. Sit. Zafer Cad. D:2  
A09 59850  
Çorlu – Tekirdağ / Türkiye

## ÇERKEZKÖY ŞUBE

- +90 (282) 726 57 99
- +90 (282) 726 17 99
- cerkezkoy@asistal.com
- G.M.K.P. Mah. Kosovalı Cad.  
Yalçınler Sokak No:10/2  
Çerkezköy – Tekirdağ / Türkiye

## BODRUM ŞUBE

- +90 (252) 363 71 27
- bodrum@asistal.com
- Konacık Mahallesi Gazderesi  
Caddesi No: 19 - 48400  
Bodrum – Muğla / Türkiye

## PENDİK ŞUBE

- +90 (216) 396 34 82
- +90 (216) 596 26 81
- pendik@asistal.com
- Fevzi Çakmak Mah. Tevfik İleri  
Cad. No: 153/A 34899  
Pendik – İstanbul / Türkiye

## İZMİR ŞUBE

- +90 (232) 461 93 14
- +90 (232) 461 84 03
- izmir@asistal.com
- 1561 Sokak No:50 35170  
Çınarlı – İzmir / Türkiye

## EDİRNE ŞUBE

- +90 (284) 235 17 22
- +90 (284) 235 17 24
- edirne@asistal.com
- Yeni San. Sit. 19. Sokak 5-A  
No:7 Edirne / Türkiye

## BURGAZ ŞUBE

- +90 (288) 413 08 85
- +90 (288) 412 84 25
- burgaz@asistal.com
- Atatürk Mah. Yeni San. Sit. D/4  
Blok No:50  
Lüleburgaz / Türkiye

## TEKİRDAĞ ŞUBE

- +90 (282) 261 17 99
- +90 (282) 261 18 99
- tekirdag@asistal.com
- 100. Yıl Mah. Yeni San. Sit.  
Demirci Sokak 6. Blok  
No:3/6-7-8 Tekirdağ / Türkiye

# REFERANS PROJELER

## REFERENCE PROJECTS



NATA – VEGA CADDE ANKARA



ÇAMLIK TEPESİ  
PROJESİ



İSTANBUL AYDIN  
ÜNİVERSİTESİ



MAHALL ANKARA



OFFICE 360  
KURTKÖY İSTANBUL



VIAPORT  
VENEZIA



**ALİ OSMAN SÖNMEZ  
DEVLET HASTANESİ  
BURSA**



**SERDAR ÖZCAN MERCEDES SHOWROOM  
İZMİR**



**BAĞCILAR BELEDİYE BİNASI  
İSTANBUL**



**SİNPAŞ ALTINORAN  
ANKARA**



**TUAL ADALAR  
KARTAL İSTANBUL**



**PARKTERAS BEŞİKDÜZÜ  
İSTANBUL**



[asistal.com](http://asistal.com)