

SL40

YALITIMSIZ SÜRME SİSTEM
UNINSULATED SLIDING SYSTEM

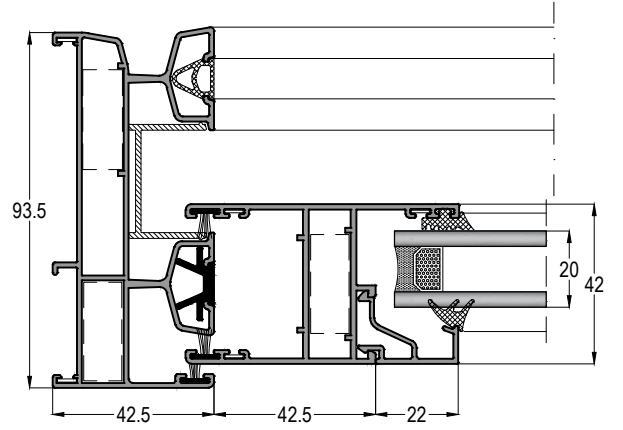
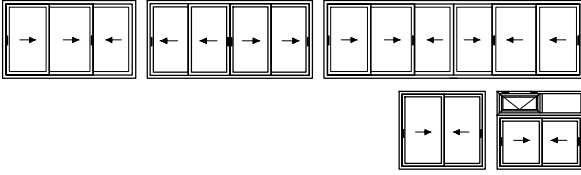

KASA GENİŞLİĞİ : 79mm - 93mm - 115mm - 146mm
Frame Width

KANAT DERİNLİĞİ : 42mm - Cam Çıtasız ve Çıtalı
Sash Depth

SİSTEM ET KALINLIĞI : 1,4mm
System Wall Thickness









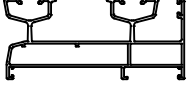
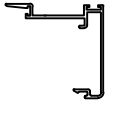
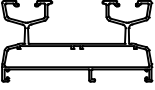

CAM KALINLIĞI : 4 - 28mm
Glass Thickness

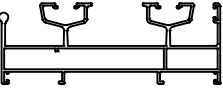
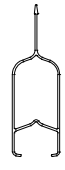
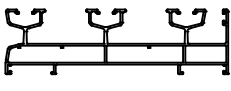
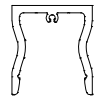
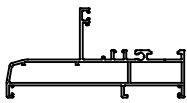
KANAT TAŞIMA KAPASİTESİ : 160 kg.
Sash Carrying Capacity

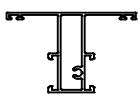
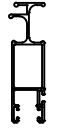
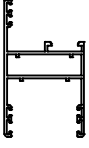
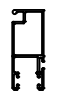
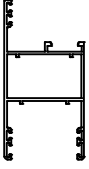

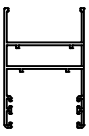

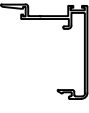





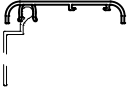

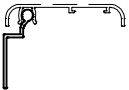



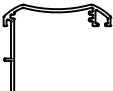



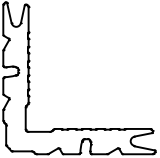







PROFİL VE AKSESUAR LİSTELERİ
PROFILE & ACCESSORIES LISTS

PROFİL LİSTESİ - PROFILES LIST

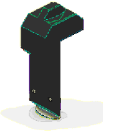

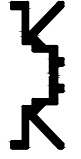
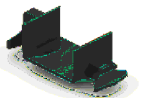
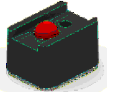
SL40 01			SL40 43		
KASA PROFİLİ FRAME PROFILE	AĞIRLIK / Weight 1,493 kg/mt		KENET PROFİLİ CENTRAL LOCKING PROFILE	AĞIRLIK / Weight 0,529 kg/mt	
SL40 02			SL40 42		
KASA PROFİLİ FRAME PROFILE	AĞIRLIK / Weight 1,230 kg/mt		ADAPTÖR PROFİLİ ADAPTER PROFILE	AĞIRLIK / Weight 0,580 kg/mt	
SL40 03			SL40 72		
KASA PROFİLİ FRAME PROFILE	AĞIRLIK / Weight 1,790 kg/mt		SABİT PANJUR LAMELİ SHUTTER BLIND	AĞIRLIK / Weight 0,491 kg/mt	
SL40 04		 sc : 1/25	LS60 71		
3 LÜ KASA PROFİLİ FRAME PROFILE	AĞIRLIK / Weight 2,165 kg/mt		KULP PROFİLİ HANDLE PROFILE	AĞIRLIK / Weight 1,430 kg/mt	
SL40 55			LS60 72		
C55 SİSTEM GEÇİŞ KASA PROFİLİ FRAME PROFILE FOR C55	AĞIRLIK / Weight 1,142 kg/mt		KULP KAPAK PROFİLİ HANDLE COVER PROFILE	AĞIRLIK / Weight 0,296 kg/mt	
SL40 21			15-306317-11		
ORTA KAYIT PROFİLİ TRANSOM-MULLION PROFILE	AĞIRLIK / Weight 0,808 kg/mt		SİNEKLİK KANAT PROFİLİ FLYSCREEN SASH PROFILE	AĞIRLIK / Weight 0,561 kg/mt	
SL40 11			15-304216-09		
Jx cm ⁴ 9,78	Jy cm ⁴ 10,07		SİNEKLİK KANAT PROFİLİ FLYSCREEN SASH PROFILE	AĞIRLIK / Weight 0,352 kg/mt	
SL40 12			SL40 44		
Jx cm ⁴ 11,19	Jy cm ⁴ 17,04		KASA KANAL PROFİLİ (mat siyah - black painted) FRAME CHANNEL PROFILE	AĞIRLIK / Weight 0,160 kg/mt	
SL40 13			SL40 61		
Jx cm ⁴ 9,43	Jy cm ⁴ 8,09		"U" TİPİ RAY PROFİLİ RAILE PROFILE TYPE "U"	AĞIRLIK / Weight 0,149 kg/mt	
SL40 41			SL40 62		
KENET PROFİLİ CENTRAL LOCKING PROFILE	AĞIRLIK / Weight 0,507 kg/mt		"V" TİPİ RAY PROFİLİ RAILE PROFILE TYPE "V"	AĞIRLIK / Weight 0,148 kg/mt	

PROFİL LİSTESİ - PROFILES LIST

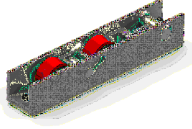
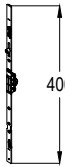

SL40 63			12-52		
RAY YUVA PROFİLİ RAIL GROOVE PROFILE	AĞIRLIK / Weight 0,140 kg/mt		PERVAZ PROFİLİ BORDER PROFILE	AĞIRLIK / Weight 0,279 kg/mt	
SL40 64			12-53		
SİNEKLİK RAY PROFİLİ FLYSCREEN RAILE PROFILE	AĞIRLIK / Weight 0,344 kg/mt		PERVAZ MONTAJ PROFİLİ BORDER FIXING PROFILE	AĞIRLIK / Weight 0,177 kg/mt	
11-004			12-54		
CAM ÇİTASI-4 mm GLAZING BEAD PROFILE	AĞIRLIK / Weight 0,181 kg/mt		PERVAZ PROFİLİ BORDER PROFILE	AĞIRLIK / Weight 0,326 kg/mt	
11-006			12-57		
CAM ÇİTASI-6 mm GLAZING BEAD PROFILE	AĞIRLIK / Weight 0,217 kg/mt		PERVAZ PROFİLİ BORDER PROFILE	AĞIRLIK / Weight 0,358 kg/mt	
11-010			12-61		
CAM ÇİTASI-10 mm GLAZING BEAD PROFILE	AĞIRLIK / Weight 0,233 kg/mt		RAY PROFİLİ RAILE PROFILE	AĞIRLIK / Weight 0,111 kg/mt	
11-015			10-010106-00		
CAM ÇİTASI-15 mm GLAZING BEAD PROFILE	AĞIRLIK / Weight 0,244 kg/mt		KÖŞE TAKOZU-10,6 mm CORNER JOINT	AĞIRLIK / Weight 2,653 kg/mt	
11-017					
CAM ÇİTASI-17 mm GLAZING BEAD PROFILE	AĞIRLIK / Weight 0,250 kg/mt				
11-020					
CAM ÇİTASI-20 mm GLAZING BEAD PROFILE	AĞIRLIK / Weight 0,276 kg/mt				
11-022					
CAM ÇİTASI-22 mm GLAZING BEAD PROFILE	AĞIRLIK / Weight 0,282 kg/mt				
11-026					
CAM ÇİTASI-26 mm GLAZING BEAD PROFILE	AĞIRLIK / Weight 0,296 kg/mt				

EP1-01			ASI-SFP 01		
DİŞ CAM FİTİLİ - 3,5 mm OUTER GLAZING GASKET	KOLİ MİKTARI/Package 240 mt / 15 kg		HAVA KESİCİ - ALT/ÜST CENTRAL SEALING TOP / BOTTOM	KOLİ MİKTARI/Package Adet / Piece	
EP2-01			ASI-SFP 02		
İÇ CAM FİTİLİ - 3 mm INNER GLAZING GASKET	KOLİ MİKTARI/Package 440 mt / 15 kg		HAVA KESİCİ - ALT/ÜST (SL40 04 KASA İÇİN) CENTRAL SEALING TOP / BOTTOM - FOR SL40 04	KOLİ MİKTARI/Package Adet / Piece	
EP2-02			SL40-PLU 01		
İÇ CAM FİTİLİ - 4 mm INNER GLAZING GASKET	KOLİ MİKTARI/Package 300 mt / 15 kg		KASA KANAL PVC FRAME PVC CHANNEL	KOLİ MİKTARI/Package 6 mt / Adet	
EP2-03			SL40-STP		
İÇ CAM FİTİLİ - 5 mm INNER GLAZING GASKET	KOLİ MİKTARI/Package 250 mt / 15 kg		KANAT GÜVENLİK PLASTİĞİ ANTI-LIFT DEVICE	KOLİ MİKTARI/Package Adet / Piece	
KC 06			SL40-KNL		
CAM FİTİLİ - 6 mm GLAZING GASKET	KOLİ MİKTARI/Package 100 mt / 15 kg		İSPANYOLET KİLİTLEME PVC ADAPTÖR MULTI POINT LOCK ADAPTER	KOLİ MİKTARI/Package Adet / Piece	
SKF-01			SL40-KP02		
SÜRME KAPATMA FİTİLİ SLIDING GASKET	KOLİ MİKTARI/Package 265 mt / 15 kg		4 LÜ KANAT KİLİTLEME ADAPTÖR KAPAĞI MEETING STILE CAP	KOLİ MİKTARI/Package Adet / Piece	
MO-60			ASI-STP 03		
BİNİ FİTİLİ SEALING GASKET	KOLİ MİKTARI/Package 200 mt		KANAT STOPER SASH STOPPER	KOLİ MİKTARI/Package Adet / Piece	
INT1-03			SL40-KP01		
CAM FİTİLİ - 10mm GLASS GASKET - 10mm	KOLİ MİKTARI/Package 500 mt / 15 kg		KENET KAPAĞI-ALT/ÜST INTERLOCK PROFILE CAP TOP / BOTTOM	KOLİ MİKTARI/Package Adet / Piece	
KF 67-700			MO60-19		
FİRÇA FİTİL - 7mm BRUSH GASKET	KOLİ MİKTARI/Package 1200 mt		KOL PROFİL KAPAĞI HANDLE PROFILE CAP	KOLİ MİKTARI/Package alt-üst takım / set	
ASI-5025			ASI-INR 01		
SİNEKLİK FİTİLİ FLYSCREEN GASKET	KOLİ MİKTARI/Package 100 mt		ÇELİK RAY STEEL RAIL	KOLİ MİKTARI/Package 3,5 mt / Adet	

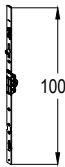
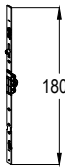
AKSESUAR LİSTESİ - ACCESSORIES LIST

ASI-SH 007			ASI-WH 002		
HAVUZ KOL <i>EMBEDED HANDLE</i>	KOLİ MİKTARI/Package Adet / Piece		İSPANYOLET KİLİTLEME KOL <i>MULTI POINT LOCK HANDLE</i>	KOLİ MİKTARI/Package Adet / Piece	
ASI-SH 007A			ASI-WH 006		
KİLİTLİ HAVUZ KOL <i>EMBEDED HANDLE WITH LOCK</i>	KOLİ MİKTARI/Package Adet / Piece		GÖMME İSPANYOLET KİLİTLEME KOL <i>EMBEDED HANDLE FOR MULTI POINT LOCK</i>	KOLİ MİKTARI/Package Adet / Piece	
ASI-SH 007B			ASI-SR 02		
ÇEKME HAVUZ KOL <i>PULL EMBEDED HANDLE</i>	KOLİ MİKTARI/Package Adet / Piece		AYARLI ÇİFTLİ RULMAN (V TİPİ RAY İÇİN) <i>DOUBLE SLIDING ROLLER FOR RAIL TYPE - V</i>	KOLİ MİKTARI/Package Adet / Piece	
ASI-SH 007K			ASI-SR 02R		
HAVUZ KOL DİL-KARŞILIK (ASI-SH 007 ve 007A için) <i>EMBEDED HANDLE STRIKE HOOK FOR ASI-SH 007/007A</i>	KOLİ MİKTARI/Package Takım / Set		AYARLI ÇİFTLİ RULMAN (U TİPİ RAY İÇİN) <i>DOUBLE SLIDING ROLLER FOR RAIL TYPE - U</i>	KOLİ MİKTARI/Package Adet / Piece	
ASI-SH 005			ASI-SR 05R		
SÜRME ÇEKME KOL <i>PULL HANDLE</i>	KOLİ MİKTARI/Package Adet / Piece		AYARLI ÇİFTLİ RULMAN (U TİPİ RAY İÇİN)80+80kg <i>DOUBLE SLIDING ROLLER FOR RAIL TYPE - U</i>	KOLİ MİKTARI/Package Adet / Piece	
ASI-ISP15.0			ASI-BZ 5060		
İSPANYOLET KİLİTLEME (400mm) <i>MULTI POINT LOCK</i>	KOLİ MİKTARI/Package Adet / Piece		SİNEKLİK KANAT RULMAN <i>FLYSCREEN SASH ROLLER</i>	KOLİ MİKTARI/Package Adet / Piece	
ASI-ISP15.1			ASI-SB 19		
İSPANYOLET KİLİTLEME (600mm) <i>MULTI POINT LOCK</i>	KOLİ MİKTARI/Package Adet / Piece		KÖŞE GÖNYESİ <i>CORNER ALIGNMENT</i>	KOLİ MİKTARI/Package 1000 Adet / Piece	
ASI-ISP15.2			EM 12-54		
İSPANYOLET KİLİTLEME (1000mm) <i>MULTI POINT LOCK</i>	KOLİ MİKTARI/Package Adet / Piece		KÖŞE GÖNYESİ <i>CORNER ALIGNMENT</i>	KOLİ MİKTARI/Package 1000 Adet / Piece	
ASI-ISP15.3			ASI-SB 34		
İSPANYOLET KİLİTLEME (1800mm) <i>MULTI POINT LOCK</i>	KOLİ MİKTARI/Package Adet / Piece		KÖŞE GÖNYESİ <i>CORNER ALIGNMENT</i>	KOLİ MİKTARI/Package 1000 Adet / Piece	
ASI-ISP K03			ASI-P 100.1		
İSPANYOLET KİLİT KARŞILIK <i>MULTI POINT LOCK STRIKER</i>	KOLİ MİKTARI/Package Adet / Piece		ORTA KAYIT BAĞLANTI <i>T JOINT FIXING</i>	KOLİ MİKTARI/Package 250 Adet / Piece	

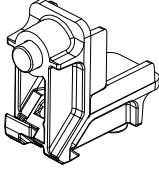
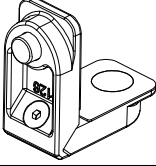
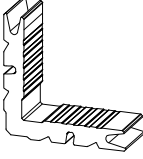
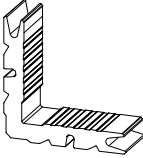
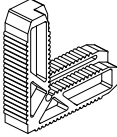
AKSESUAR LİSTESİ - ACCESSORIES LIST

ASI-PB 2326				
PİMLİ KÖŞE BAĞLANTI <i>CORNER JOINT</i>	KOLİ MİKTARI/Package Adet / Piece			
ASI-PB 1126				
PİMLİ KÖŞE BAĞLANTI <i>CORNER JOINT</i>	KOLİ MİKTARI/Package Adet / Piece			
ASI-KT 2660				
KÖŞE TAKOZU <i>CORNER JOINT</i>	KOLİ MİKTARI/Package Adet / Piece			
ASI-KT 1126				
KÖŞE TAKOZU <i>CORNER JOINT</i>	KOLİ MİKTARI/Package Adet / Piece			
ASI-BZ 5007				
SİNEKLİK KÖŞE TAKOZU <i>FLYSCREEN CORNER JOINT</i>	KOLİ MİKTARI/Package Adet / Piece			
501 EKO PANÇ				
KÖŞE PİMLİ BAĞLANTI PANÇ MAKİNESİ <i>PUNCH MACHINE FOR</i> <i>CORNER JOINT WITH PIN</i>	KOLİ MİKTARI/Package Adet / Piece			

SL40 - 1,4mm

YALITIMSIZ SÜRME SİSTEM
UNINSULATED SLIDING SYSTEM

ASISTAL

PROFİL DETAYLARI
PROFILE DETAILS



SL40 - 1,4mm

YALITIMSIZ SÜRME SİSTEM
UNINSULATED SLIDING SYSTEM

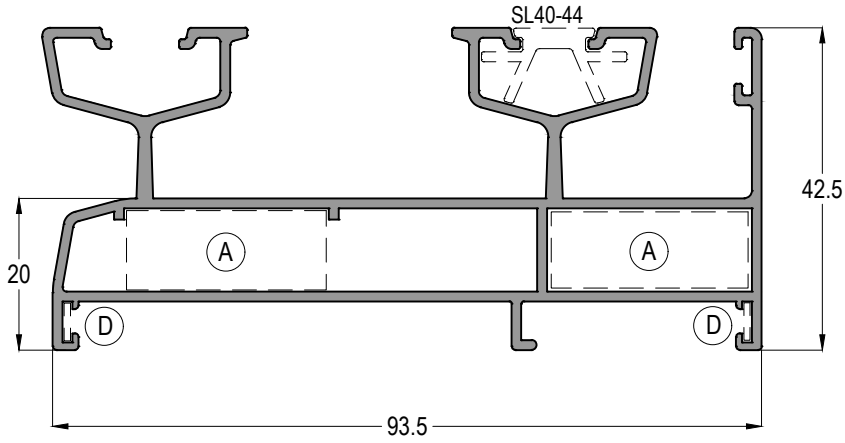
ASISTAL



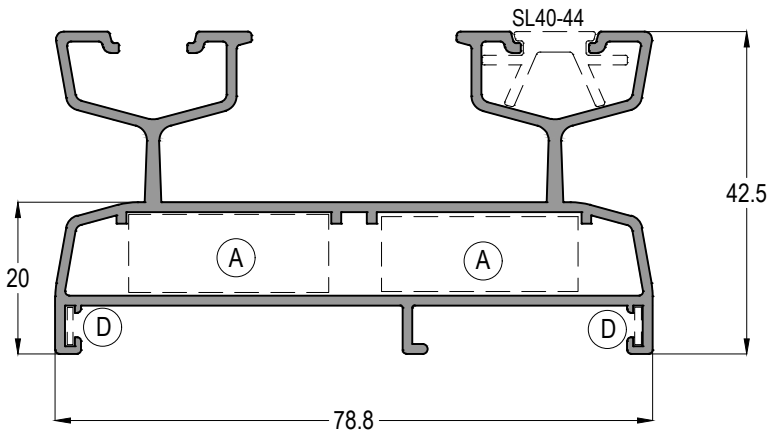

SL40 01

 (A)	 (D)	AĞIRLIK / Weight
ASI-KT 1126 ~ ASI-PB 1126	ASI-SB 19	1,493 kg/mt



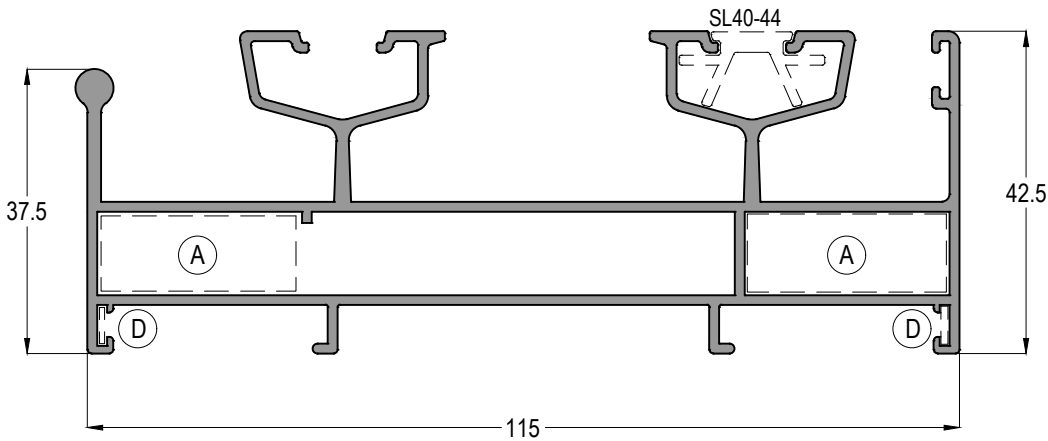

SL40 02

 (A)	 (D)	AĞIRLIK / Weight
ASI-KT 1126 ~ ASI-PB 1126	ASI-SB 19	1,230 kg/mt



SL40 03

 (A)	 (D)	AĞIRLIK / Weight
ASI-KT 1126 ~ ASI-PB 1126	ASI-SB 19	1,790 kg/mt

Profil ağırlıklarımız teorik olup; teslim anındaki tartımız geçerlidir.
Profile weights are theoretical and the weight at the time of delivery is valid.



SL40 - 1,4mm

YALITIMSIZ SÜRME SİSTEM
UNINSULATED SLIDING SYSTEM

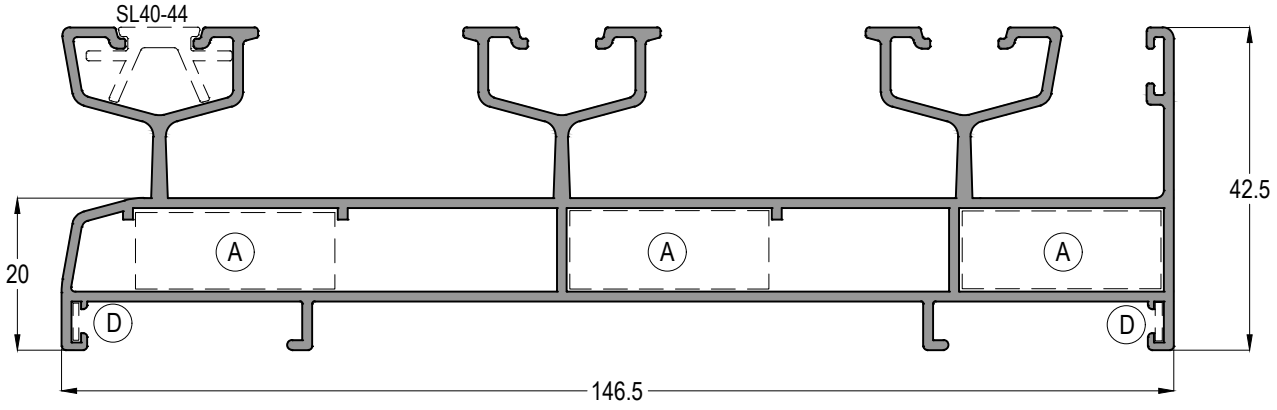
ASISTAL



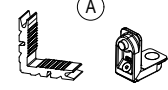

SL40 04

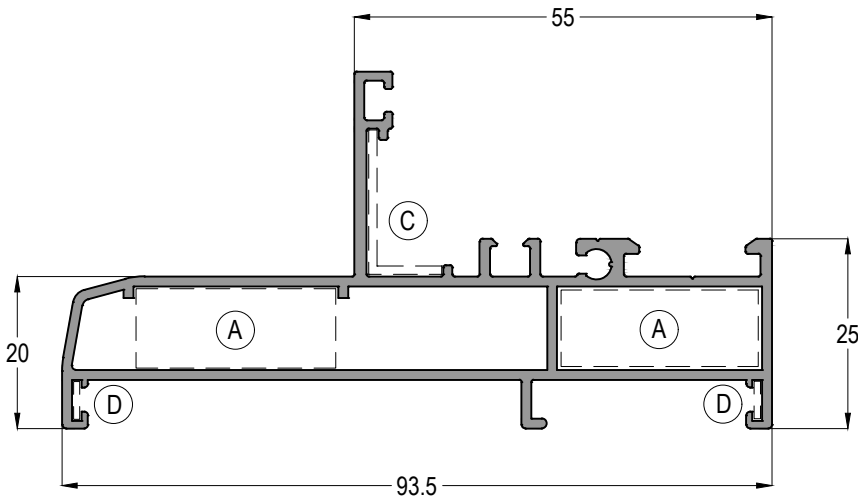
		AĞIRLIK / Weight
		2,165 kg/mt



SL40 55

			AĞIRLIK / Weight
			1,142 kg/mt

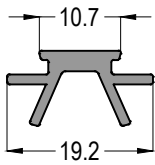

SL40 44

(mat siyah eloksal)

AĞIRLIK / Weight

0,160 kg/mt

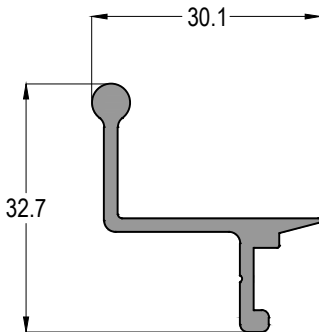

SL40 64

AĞIRLIK / Weight

0,344 kg/mt

SL40 - 1,4mm

YALITIMSIZ SÜRME SİSTEM
UNINSULATED SLIDING SYSTEM

ASISTAL

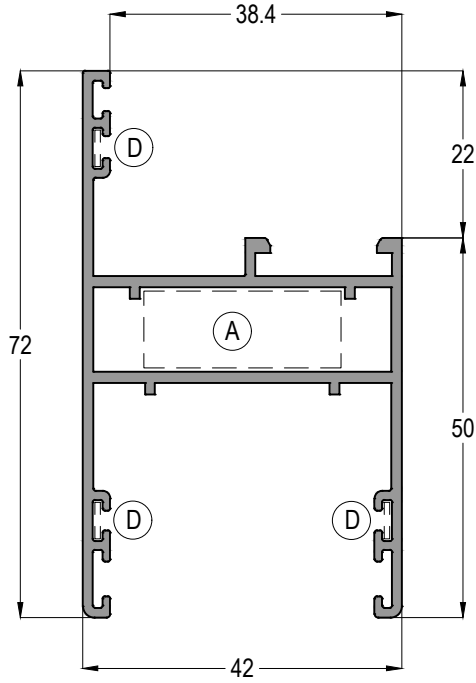

SL40 11		Jx cm ⁴	Jy cm ⁴
		9,78	10,07
AĞIRLIK / Weight			
0,938 kg/mt			

ASI-KT 1126 ~ ASI-PB 1126 ASI-SB 19

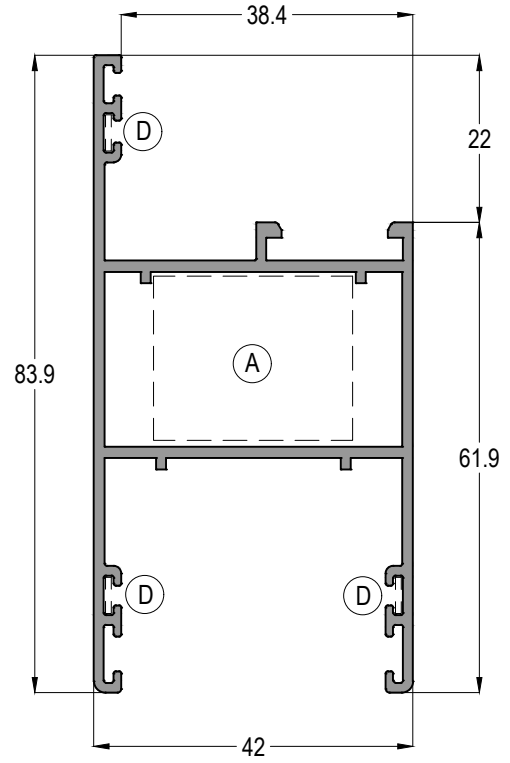

SL40 12		Jx cm ⁴	Jy cm ⁴
		11,19	17,14
AĞIRLIK / Weight			
1,023 kg/mt			

ASI-KT 2660 ~ ASI-PB 2326 ASI-SB 19

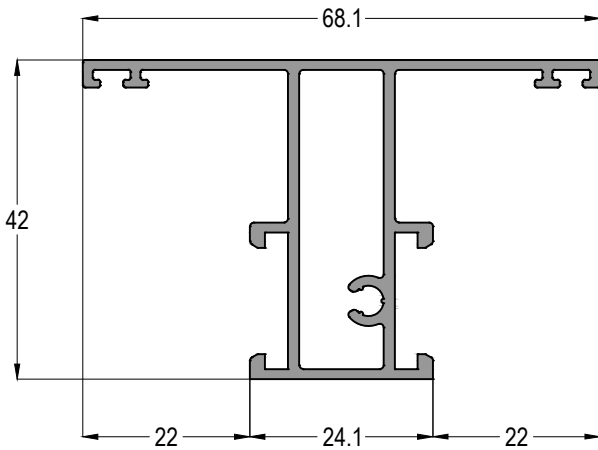

SL40 21

AĞIRLIK / Weight	
0,808 kg/mt	

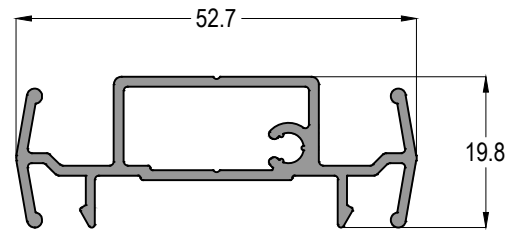

SL40 42

AĞIRLIK / Weight	
0,580 kg/mt	

SL40-KP02

Profil ağırlıklarımız teorik olup; teslim anındaki tartımız geçerlidir.
Profile weights are theoretical and the weight at the time of delivery is valid.

SL40 - 1,4mm

YALITIMSIZ SÜRME SİSTEM
UNINSULATED SLIDING SYSTEM

ASISTAL

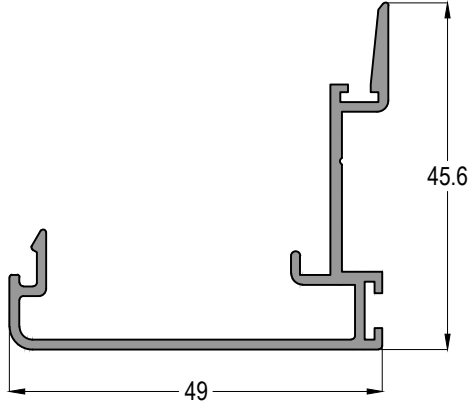

SL40 41

AĞIRLIK / Weight

0,507 kg/mt

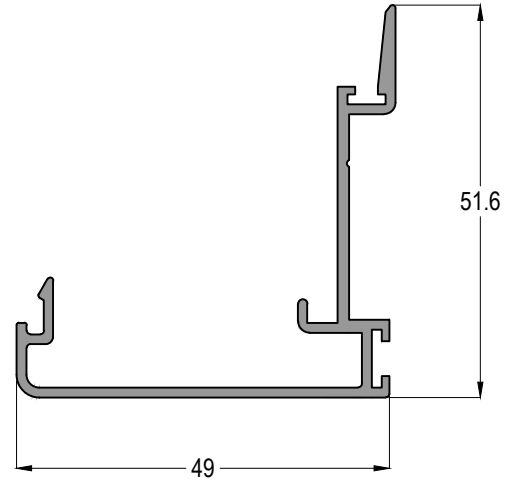

SL40 43

AĞIRLIK / Weight

0,529 kg/mt

LS60 71



AĞIRLIK / Weight

1,430 kg/mt

LS60 72

AĞIRLIK / Weight

0,296 kg/mt

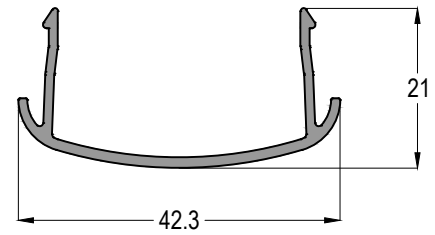
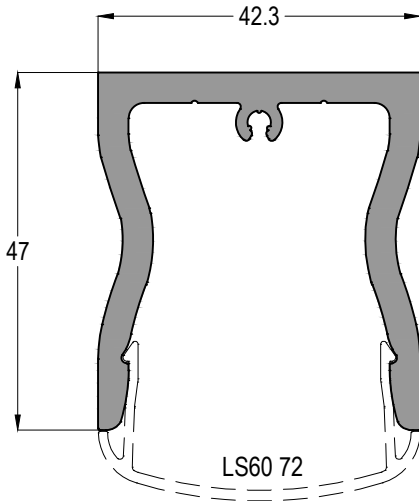

Profil ağırlıklarımız teorik olup; teslim anındaki tartımız geçerlidir.
Profile weights are theoretical and the weight at the time of delivery is valid.

SL40 - 1,4mm

YALITIMSIZ SÜRME SİSTEM
UNINSULATED SLIDING SYSTEM

ASISTAL

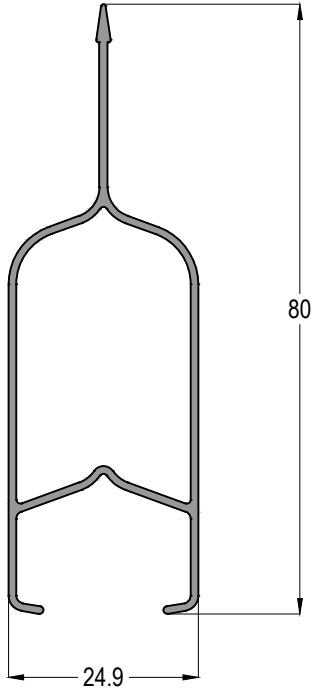

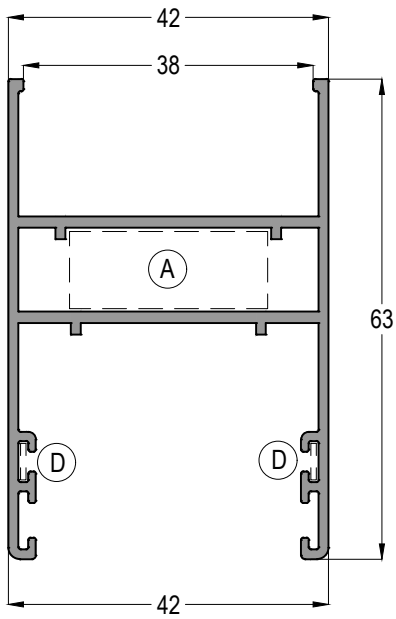

SL40 72

SL40 72	
	AĞIRLIK / Weight
	0,491 kg/mt



SL40 13

SL40 13	Jx cm ⁴	Jy cm ⁴
	9,43	8,09
 ASI-PB 1126	 ASI-SB 19	AĞIRLIK / Weight
		0,866 kg/mt

SL40 - 1,4mm

YALITIMSIZ SÜRME SİSTEM
UNINSULATED SLIDING SYSTEM



15-304216-09		
 ASI-BZ 5007	 ASI-BZ 5060	AĞIRLIK / Weight 0,352 kg/mt

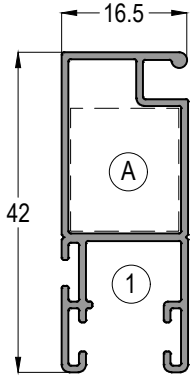

15-306317-11		
 ASI-BZ 5007	 ASI-BZ 5060	AĞIRLIK / Weight 0,561 kg/mt

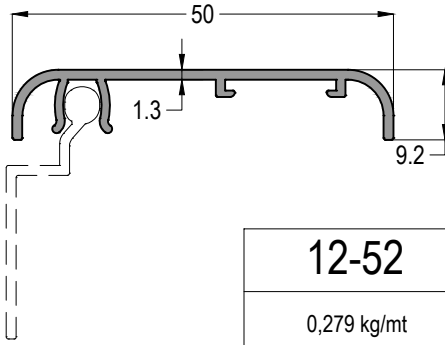
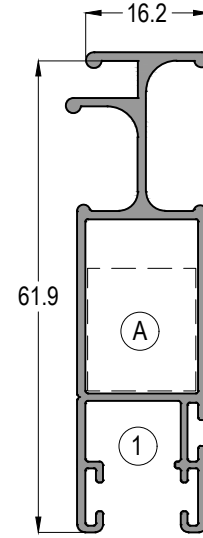

12-52
0,279 kg/mt

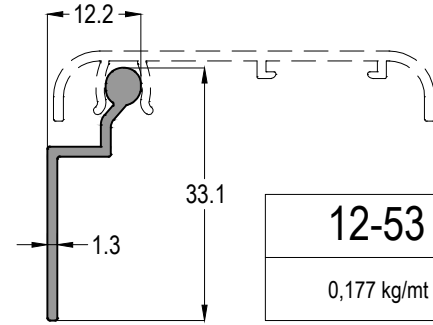

12-53
0,177 kg/mt

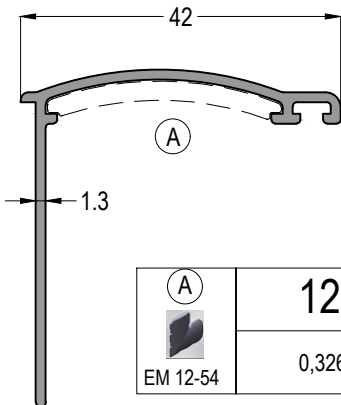

 EM 12-54	12-54
	0,326 kg/mt

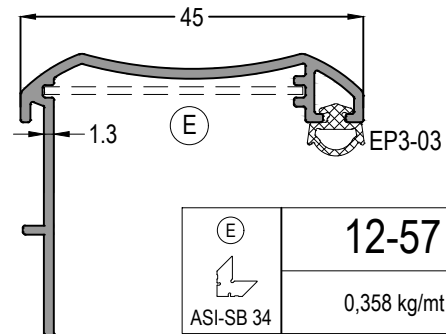

 ASI-SB 34	12-57
	0,358 kg/mt

Profil ağırlıklarımız teorik olup; teslim anındaki tartımız geçerlidir.
Profile weights are theoretical and the weight at the time of delivery is valid.

SL40 - 1,4mm

YALITIMSIZ SÜRME SİSTEM
UNINSULATED SLIDING SYSTEM

ASISTAL

SL40 61	
	AĞIRLIK / Weight
	0,149 kg/mt

SL40 62	
	AĞIRLIK / Weight
	0,148 kg/mt

SL40 63	
	AĞIRLIK / Weight
	0,140 kg/mt

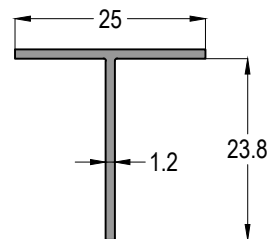
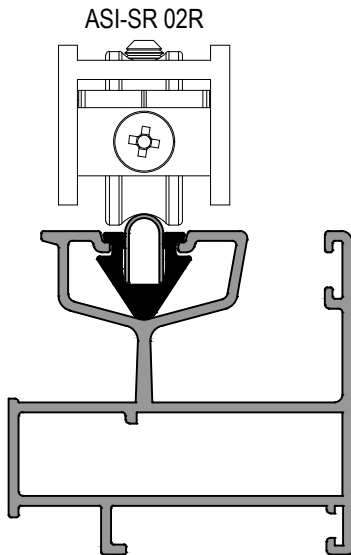
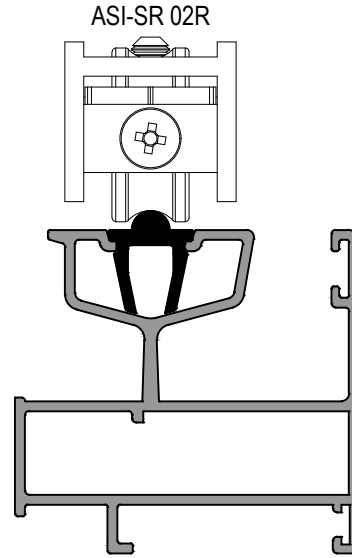
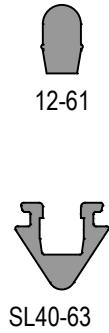
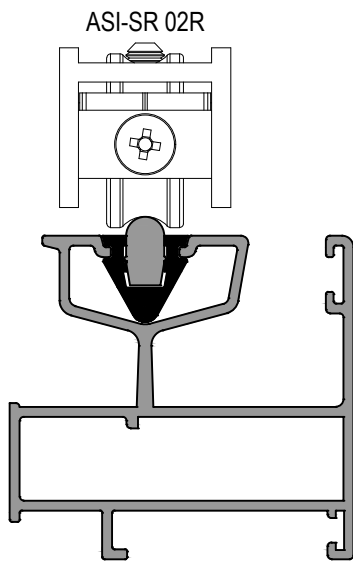
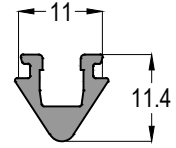
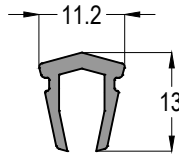
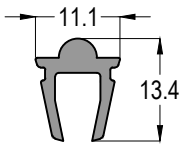

04-025025-12

0,158 kg/mt

SL40 11 ve SL40 12 KANATLARI İÇİN

SASH FOR SL40 11 & SL40 12

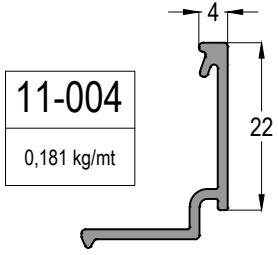

11-004

0,181 kg/mt

11-006

0,217 kg/mt

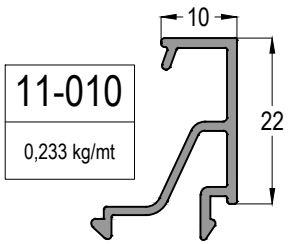
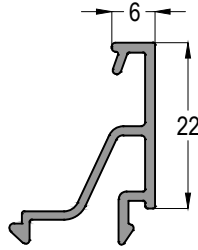

11-010

0,233 kg/mt

11-015

0,244 kg/mt

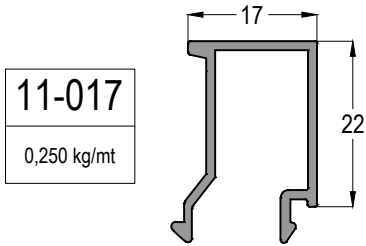
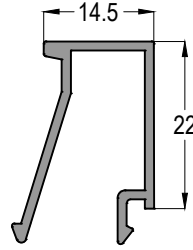

11-017

0,250 kg/mt

11-020

0,276 kg/mt

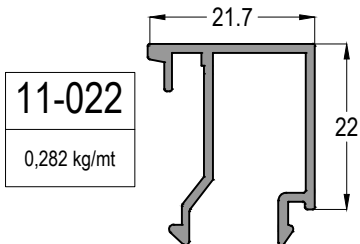
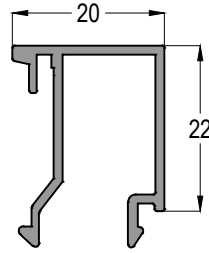

11-022

0,282 kg/mt

11-026

0,296 kg/mt

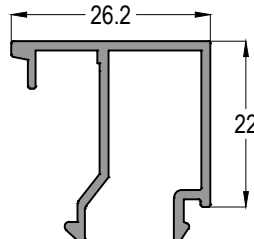
CAM KALINLIĞINA GÖRE CAM ÇİTASI SEÇİM TABLOSU
Glazing Bead Selection Table
according to the Glass Thickness

CAM KALINLIĞI Glass Thickness (mm)	CAM ÇİTASI Glazing Bead	İÇ CAM FİTLİ Glass Gasket (IN)	DIŞ CAM FİTLİ Glass Gasket (OUT)
4	11-026	EP2-03	EP1-01
5	11-026	EP2-02	EP1-01
6	11-026	EP2-01	EP1-01
8	11-022	EP2-03	EP1-01
9	11-022	EP2-02	EP1-01
10	11-022	EP2-01	EP1-01
11	11-020	EP2-02	EP1-01
12	11-020	EP2-01	EP1-01
13	11-017	EP2-03	EP1-01
14	11-017	EP2-02	EP1-01
15	11-017	EP2-01	EP1-01
16	11-015	EP2-02	EP1-01
17	11-015	EP2-01	EP1-01
20	11-010	EP2-03	EP1-01
21	11-010	EP2-02	EP1-01
22	11-010	EP2-01	EP1-01
24	11-006	EP2-03	EP1-01
25	11-006	EP2-02	EP1-01
26	11-006	EP2-01	EP1-01
27	11-004	EP2-02	EP1-01
28	11-004	EP2-01	EP1-01



AÇILIM TİPLERİ - OPENING TYPES

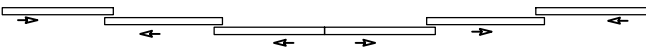
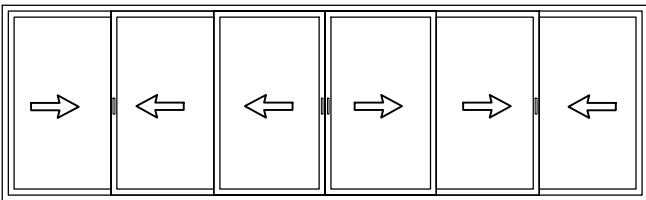
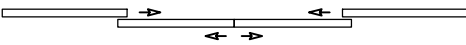
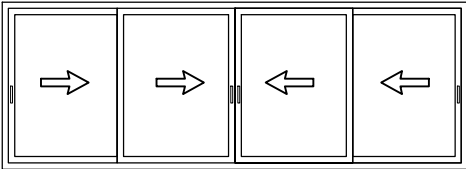
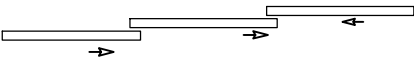
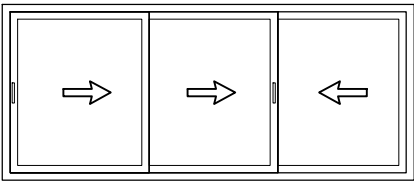
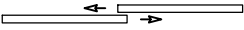
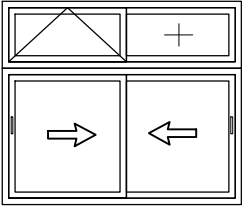
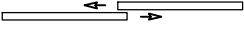
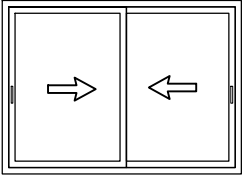

RÜZGAR YÜKÜNE GÖRE MAKSİMUM KANAT EBATLARI

MAXIMUM SASH DIMENSIONS FOR GIVEN WIND PRESSURE

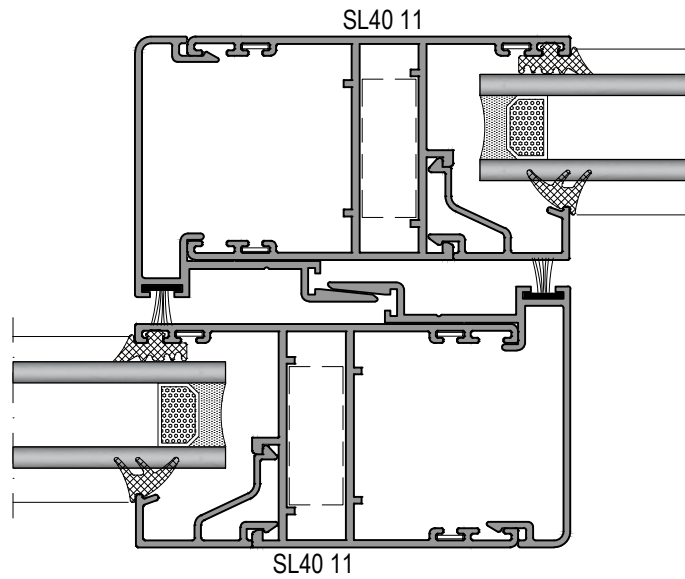
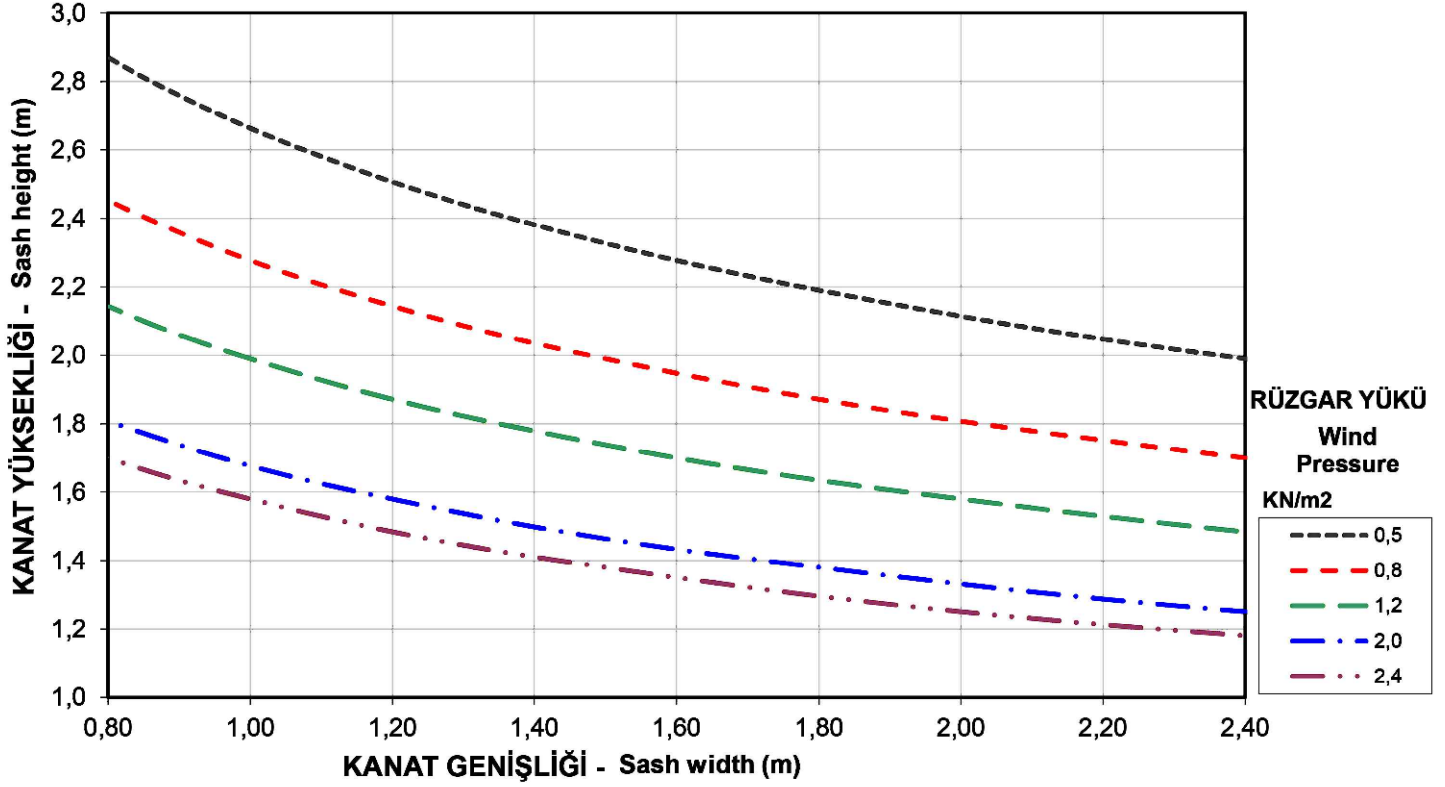

KANAT EBATLARI BELİRLENİRKEN RULMANIN TAŞIMA KAPASİTESİNİ GEÇMEMESİNE DİKKAT EDİLMELİDİR
WHILE THE DETERMINE SASH DIMENSIONS, SASH WEIGHT MUST BE LESS THAN ROLLER CARY CAPACITY

RÜZGAR YÜKÜNE GÖRE MAKSİMUM KANAT EBATLARI

MAXIMUM SASH DIMENSIONS FOR GIVEN WIND PRESSURE

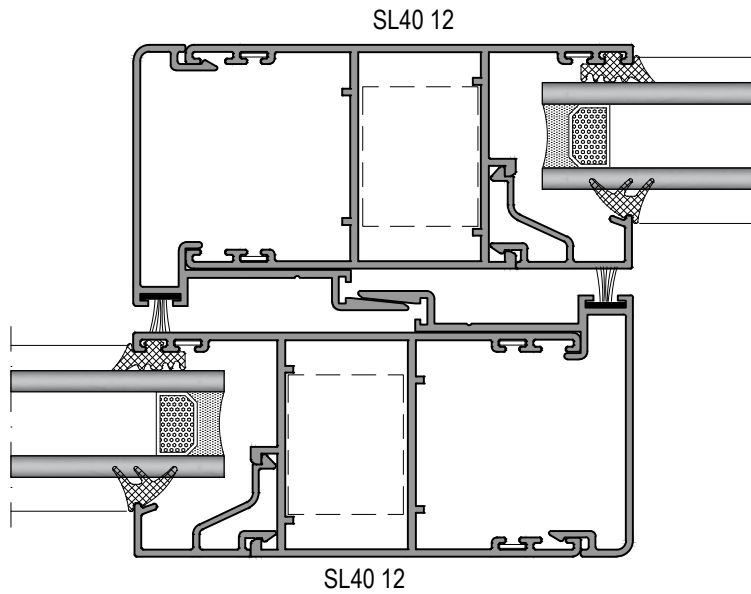
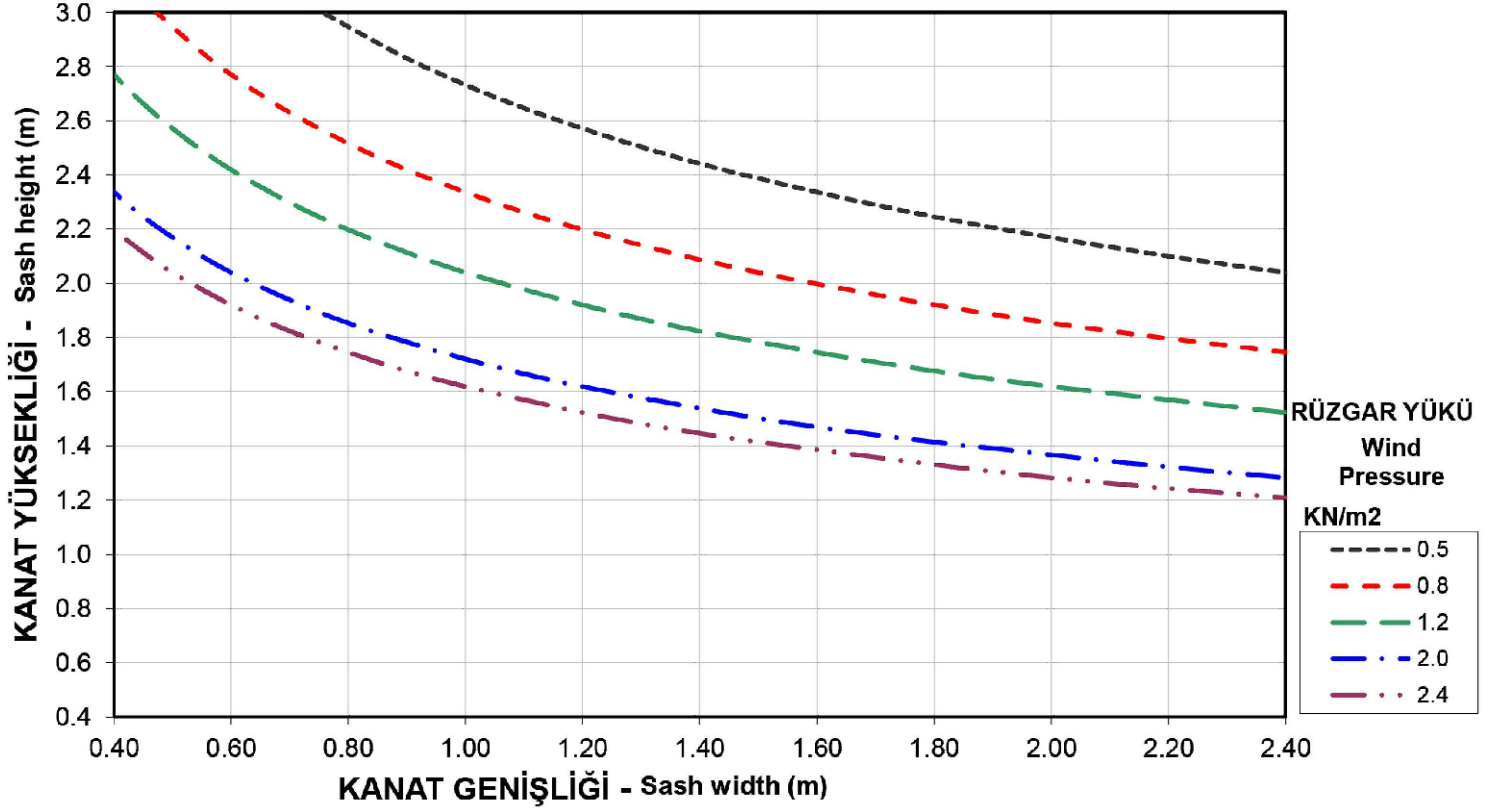

KANAT EBATLARI BELİRLENİRKEN RULMANIN TAŞIMA KAPASİTESİNİ GEÇMEMESİNE DİKKAT EDİLMELİDİR
WHILE THE DETERMINE SASH DIMENSIONS, SASH WEIGHT MUST BE LESS THAN ROLLER CARY CAPACITY

RÜZGAR YÜKÜNE GÖRE MAKSİMUM KANAT EBATLARI

MAXIMUM SASH DIMENSIONS FOR GIVEN WIND PRESSURE

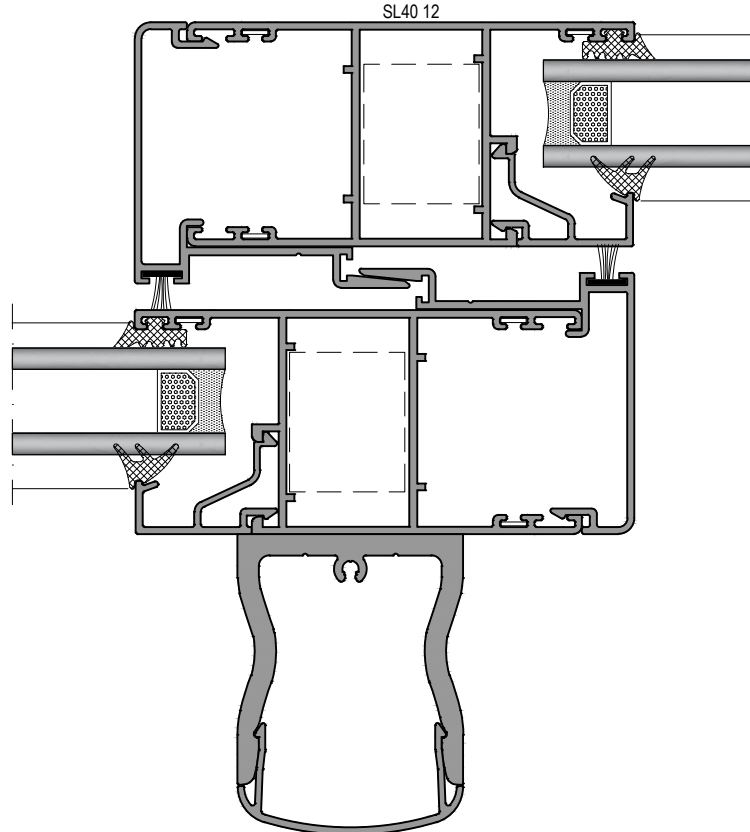
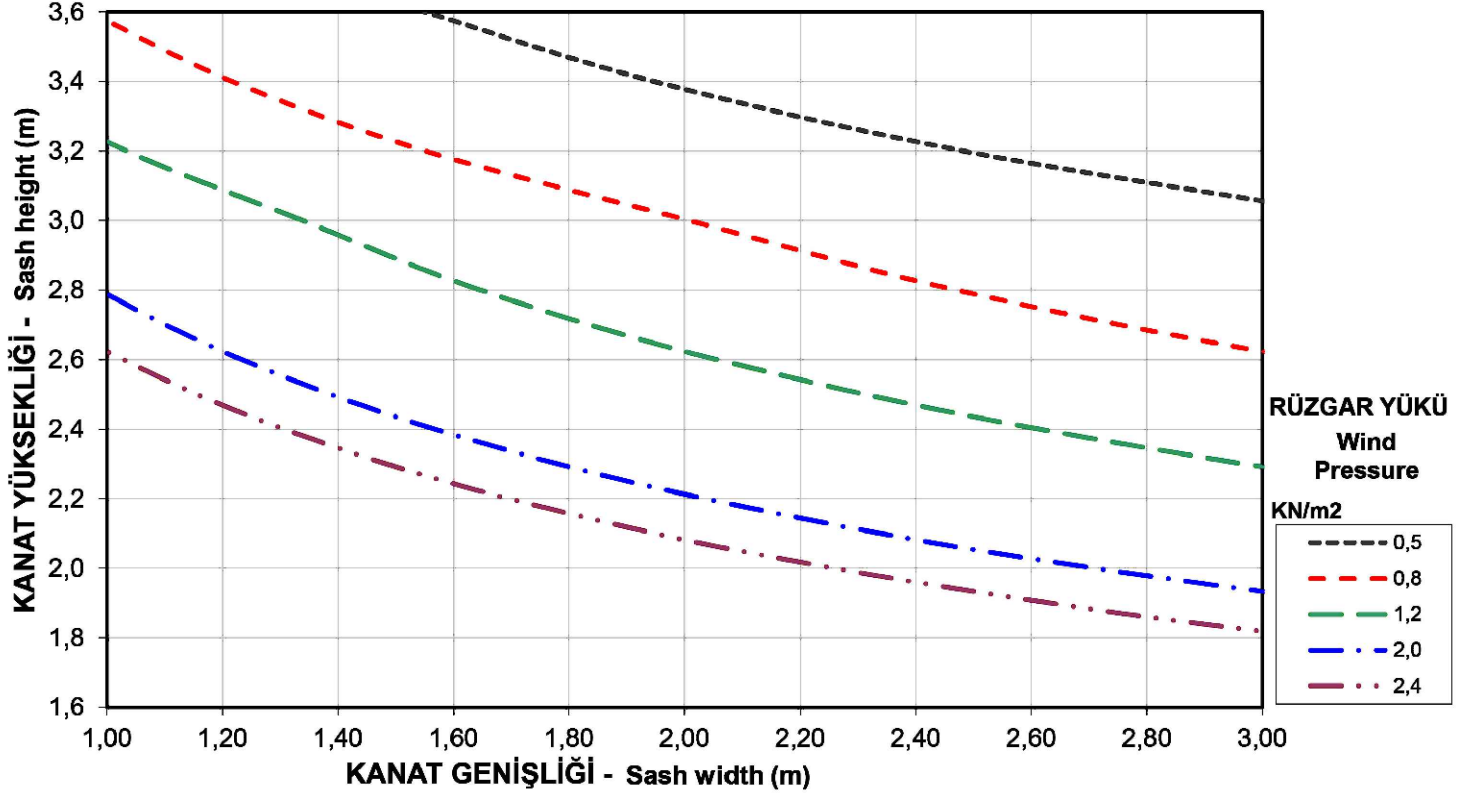

KANAT EBATLARI BELİRLENİRKEN RULMANIN TAŞIMA KAPASİTESİNİ GEÇMEMESİNE DİKKAT EDİLMELİDİR

WHILE THE DETERMINE SASH DIMENSIONS, SASH WEIGHT MUST BE LESS THAN ROLLER CARY CAPACITY

SL40 - 1,4mm

YALITIMSIZ SÜRME SİSTEM
UNINSULATED SLIDING SYSTEM

ASISTAL

SİSTEM DETAYLARI
SYSTEM DETAILS

SL40 - 1,4mm

YALITIMSIZ SÜRME SİSTEM
UNINSULATED SLIDING SYSTEM

ASISTAL

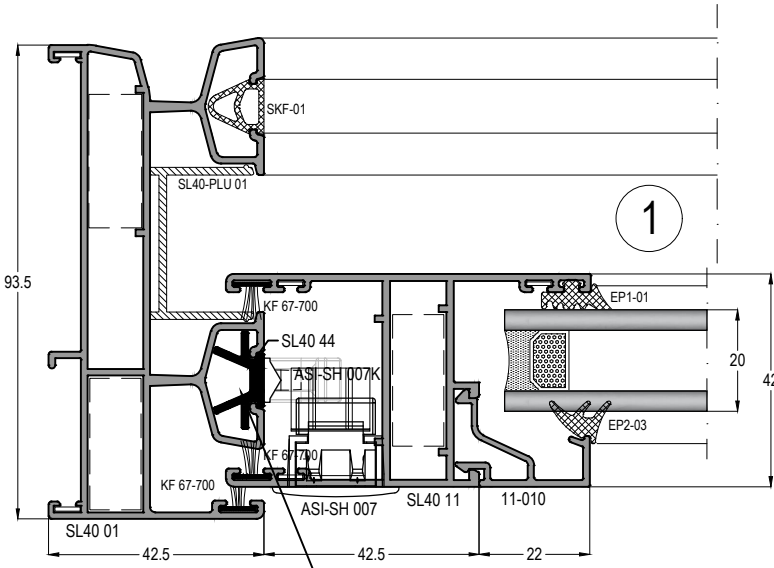

**KİLİT KARŞILIĞI KULLANILACAK TARAFTA
MUTLAKA SL40 44 PROFİLİ TAKILMALIDIR**
You have to use SL40 44 profile
in the frame for locking part

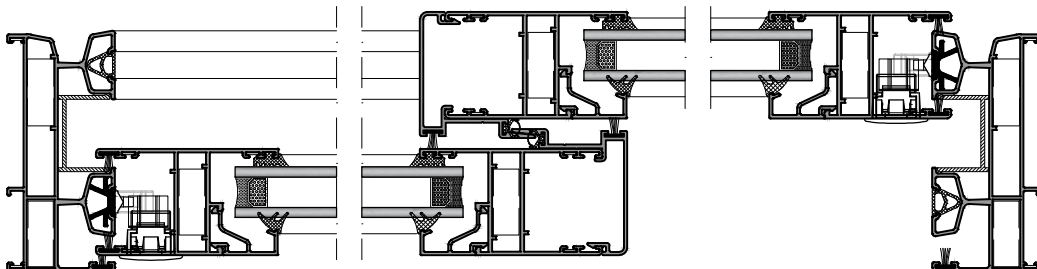
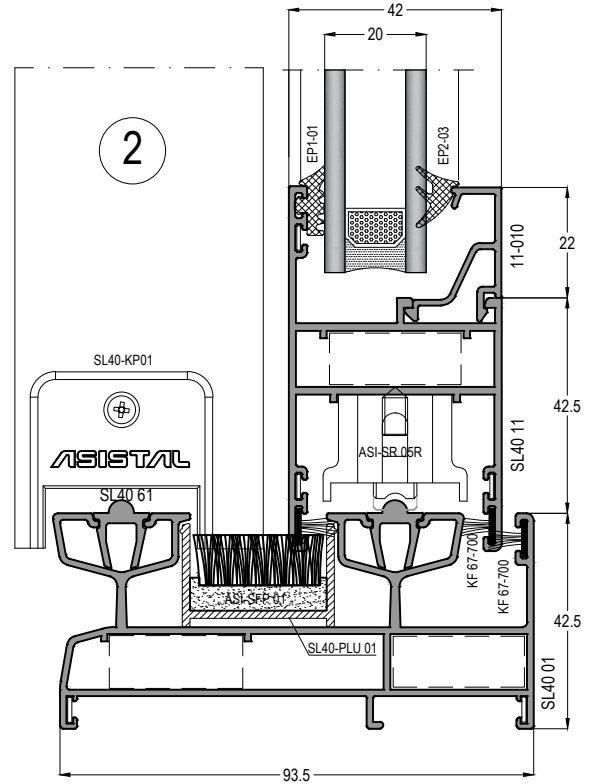
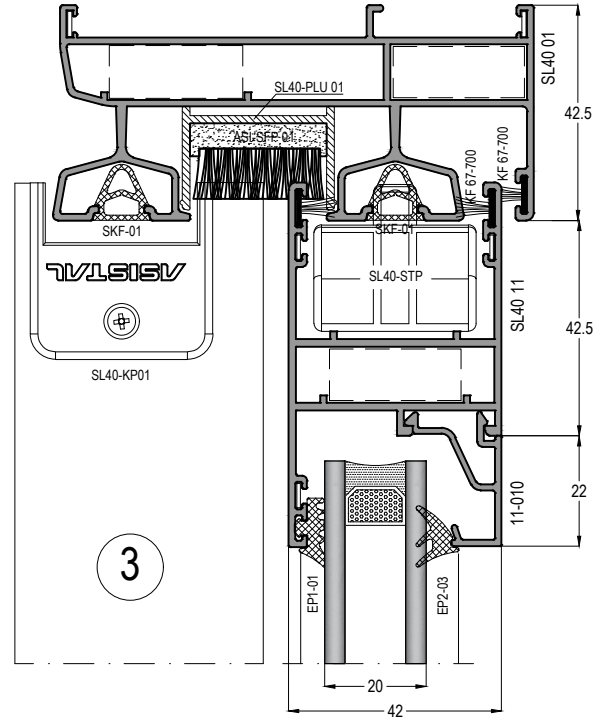
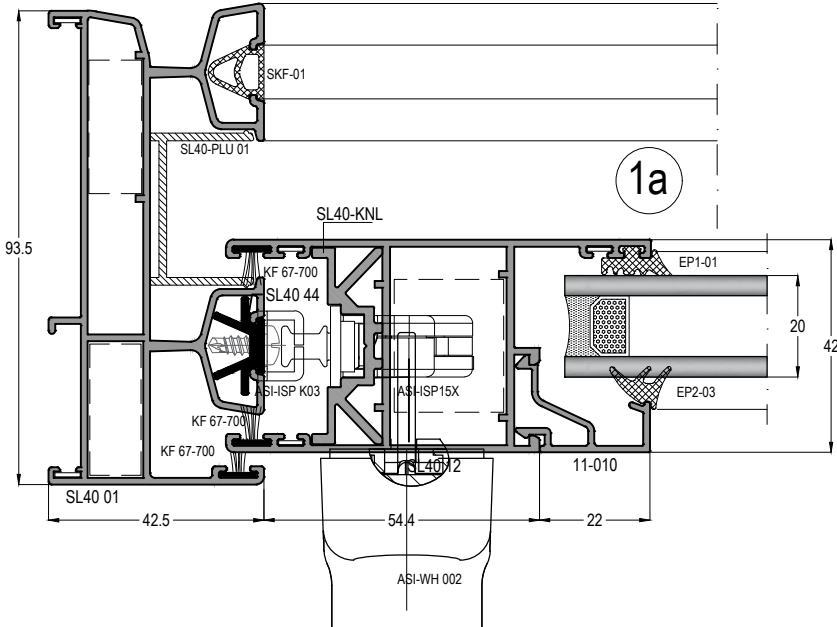
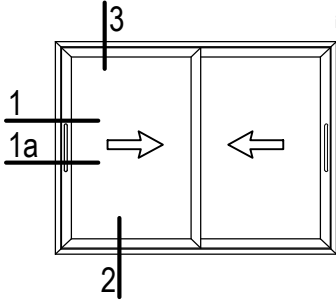

SL40 - 1,4mm

YALITIMSIZ SÜRME SİSTEM
UNINSULATED SLIDING SYSTEM

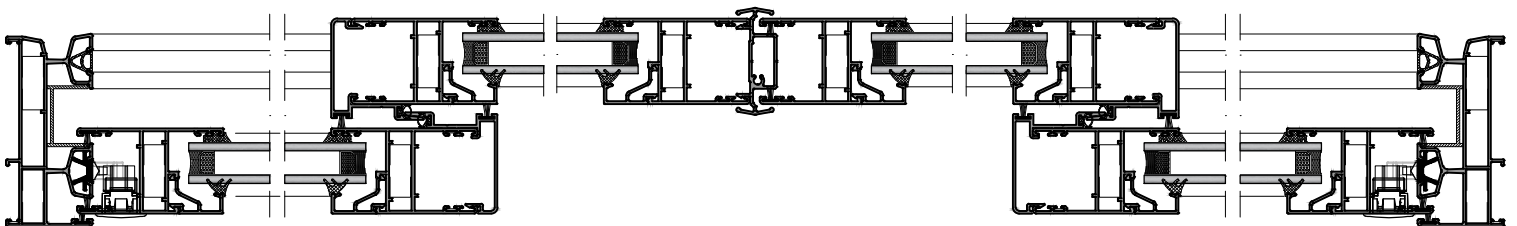
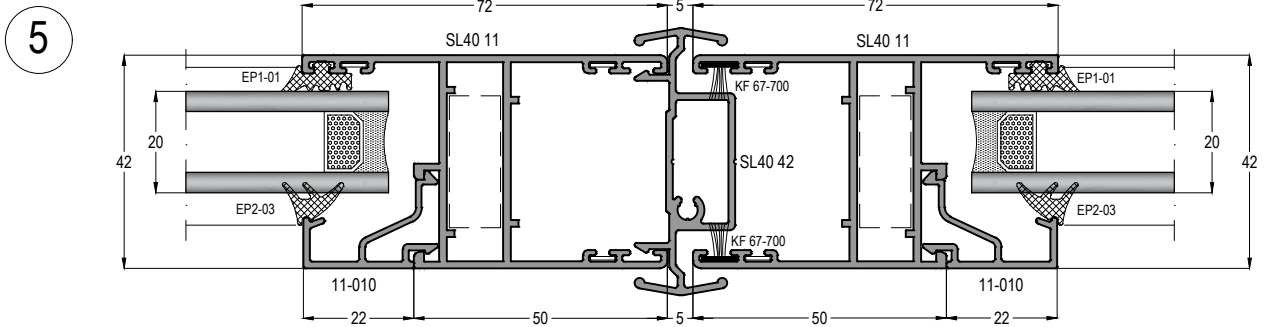
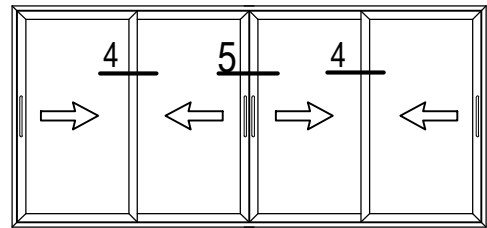
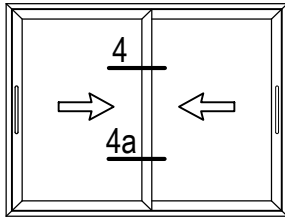
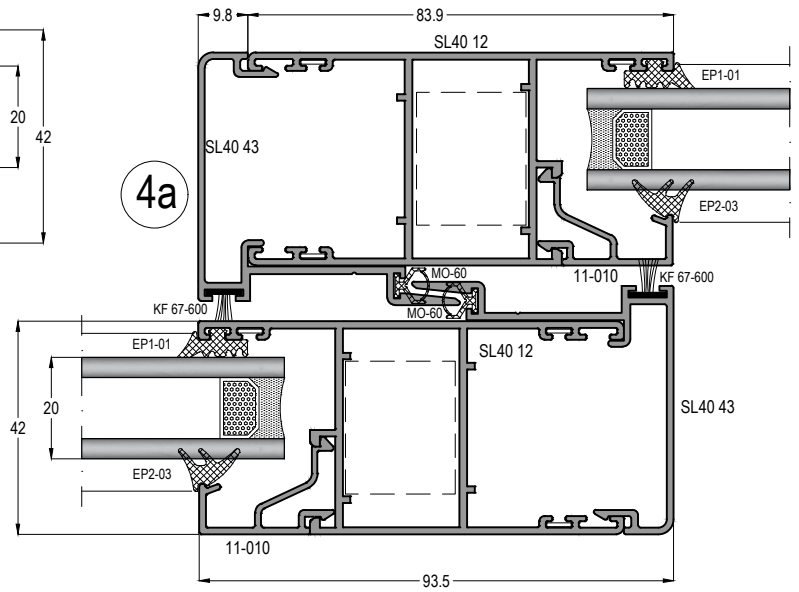
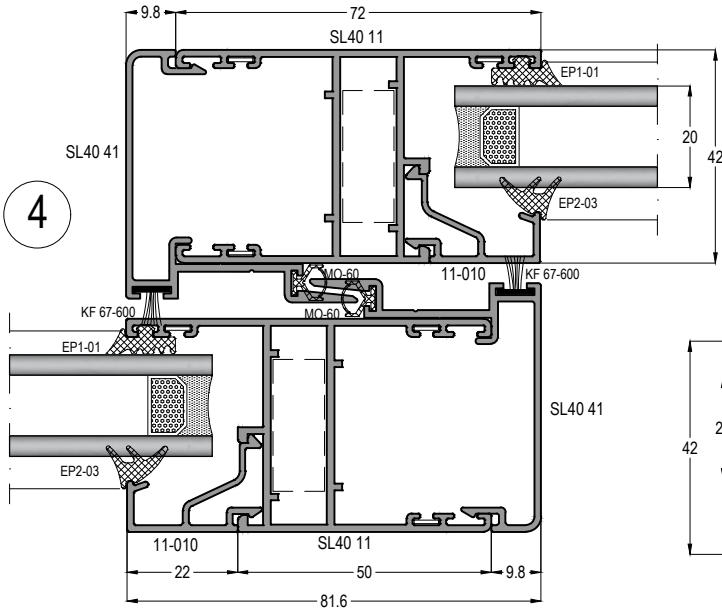

SL40 - 1,4mm

YALITIMSIZ SÜRME SİSTEM
UNINSULATED SLIDING SYSTEM

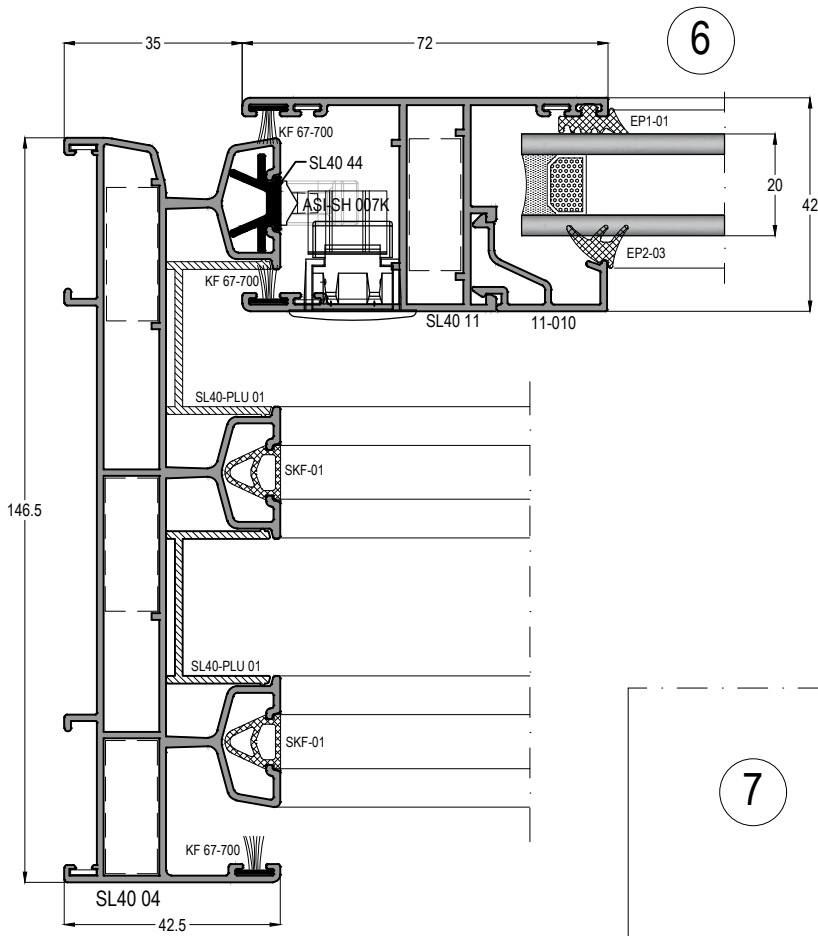

6

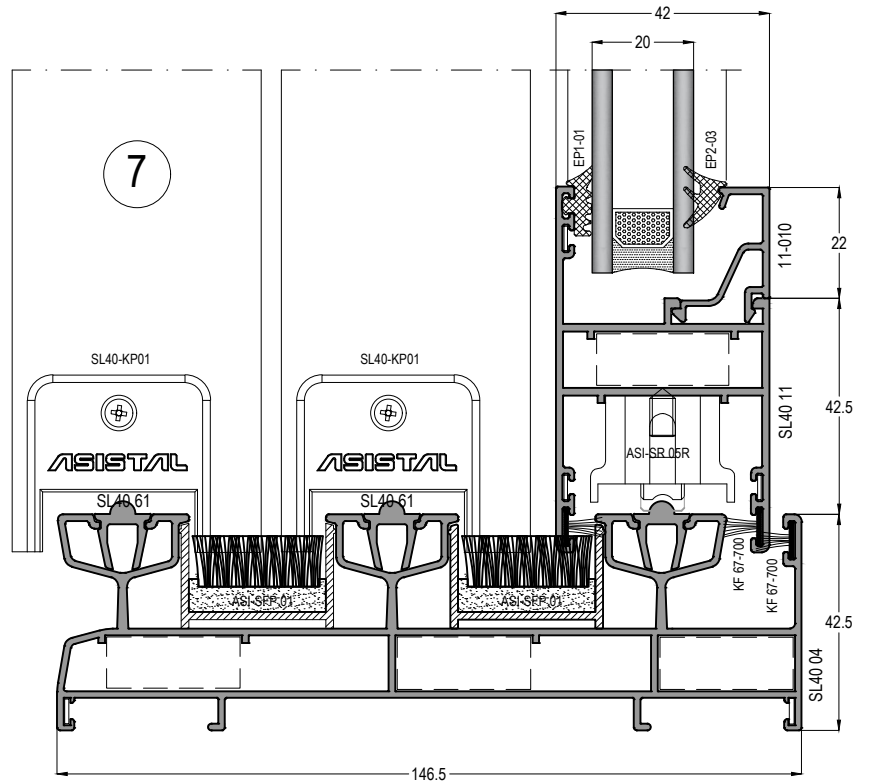
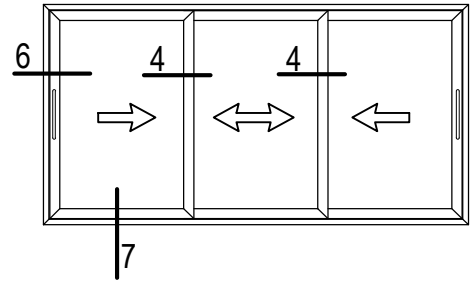

7

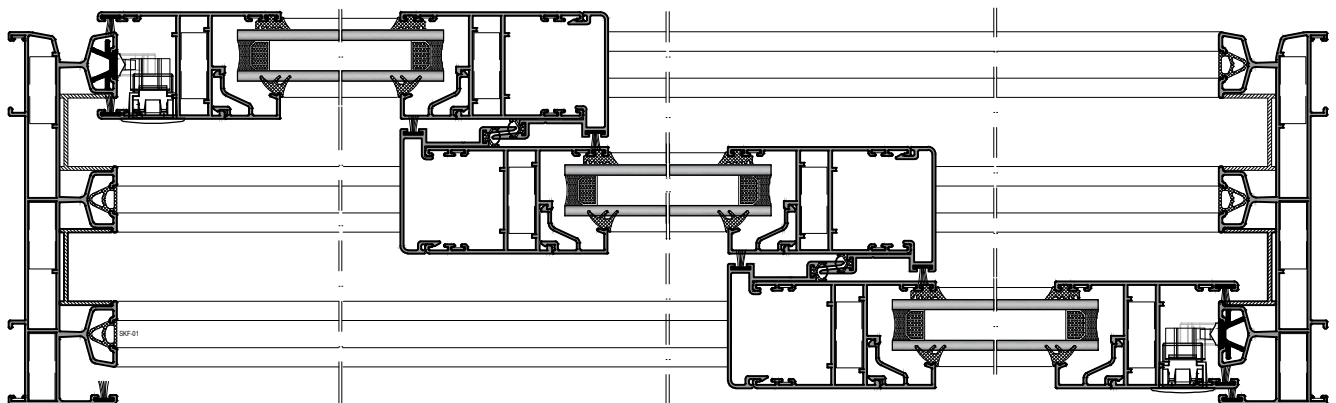

SL40 - 1,4mm

YALITIMSIZ SÜRME SİSTEMİ
UNINSULATED SLIDING SYSTEM

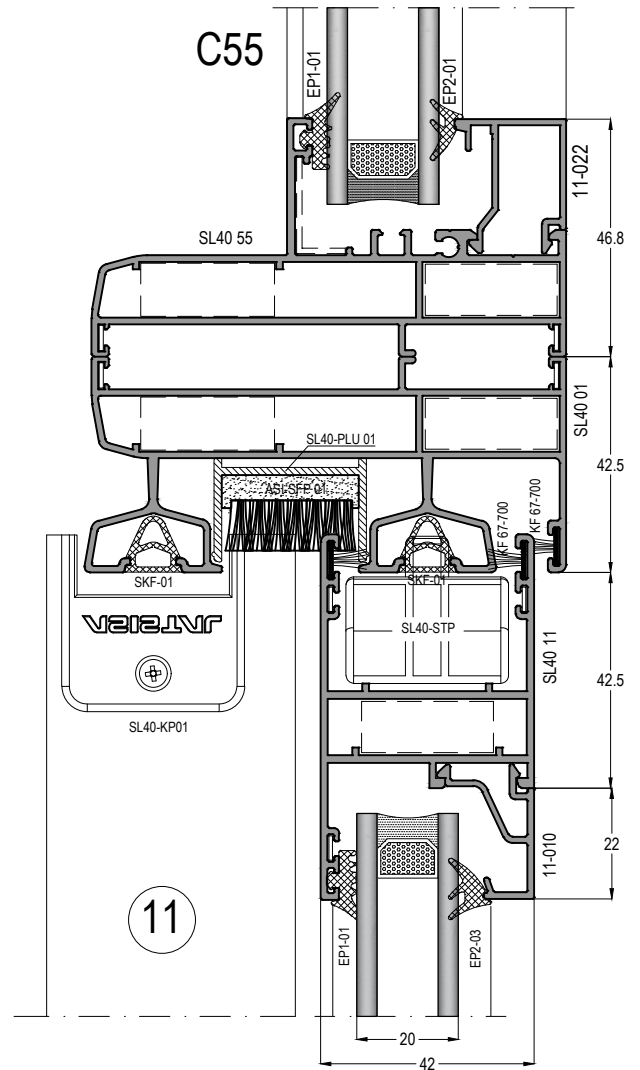
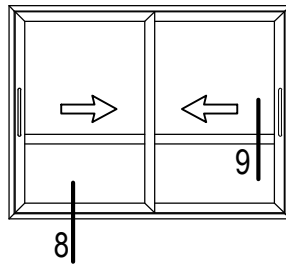
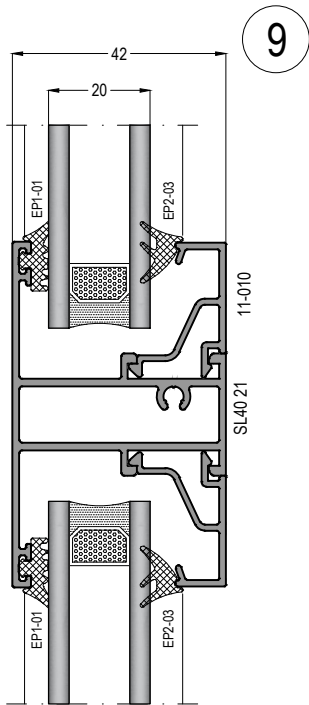
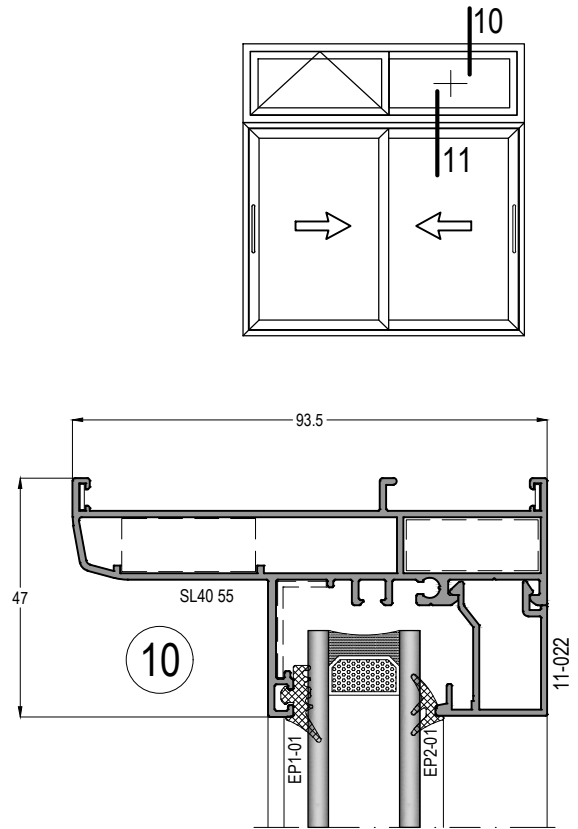
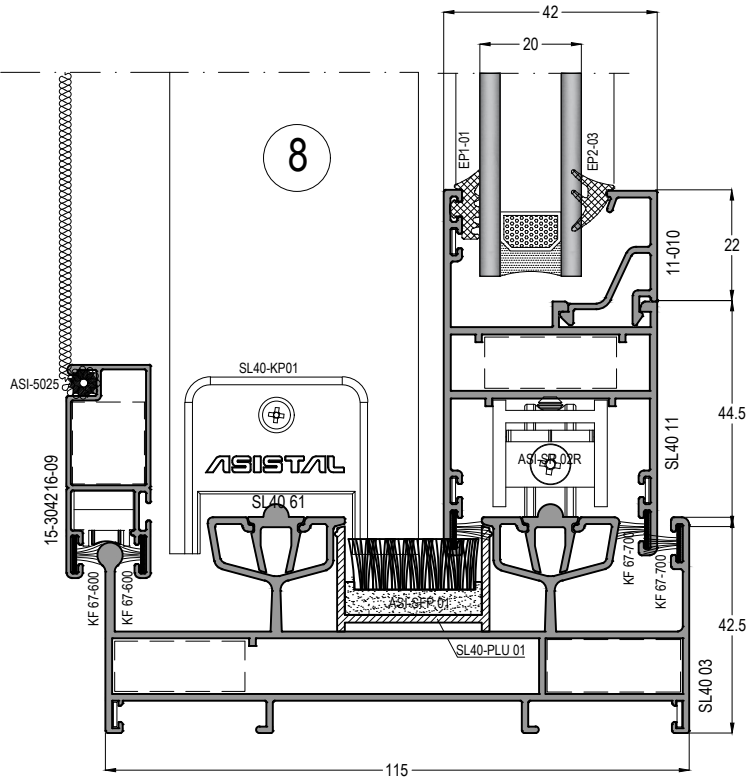

SL40 - 1,4mm

YALITIMSIZ SÜRME SİSTEM
UNINSULATED SLIDING SYSTEM

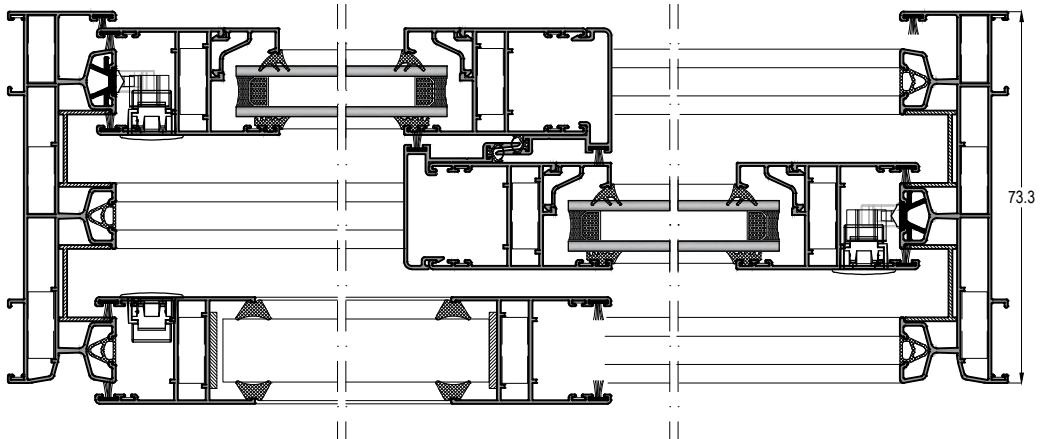
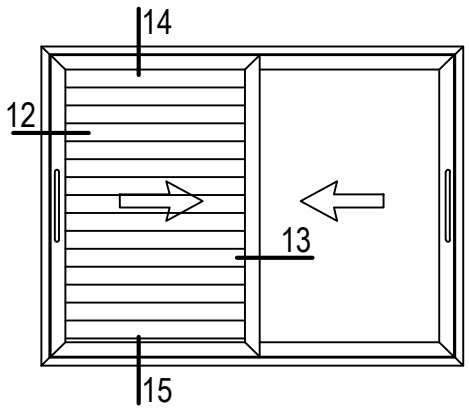
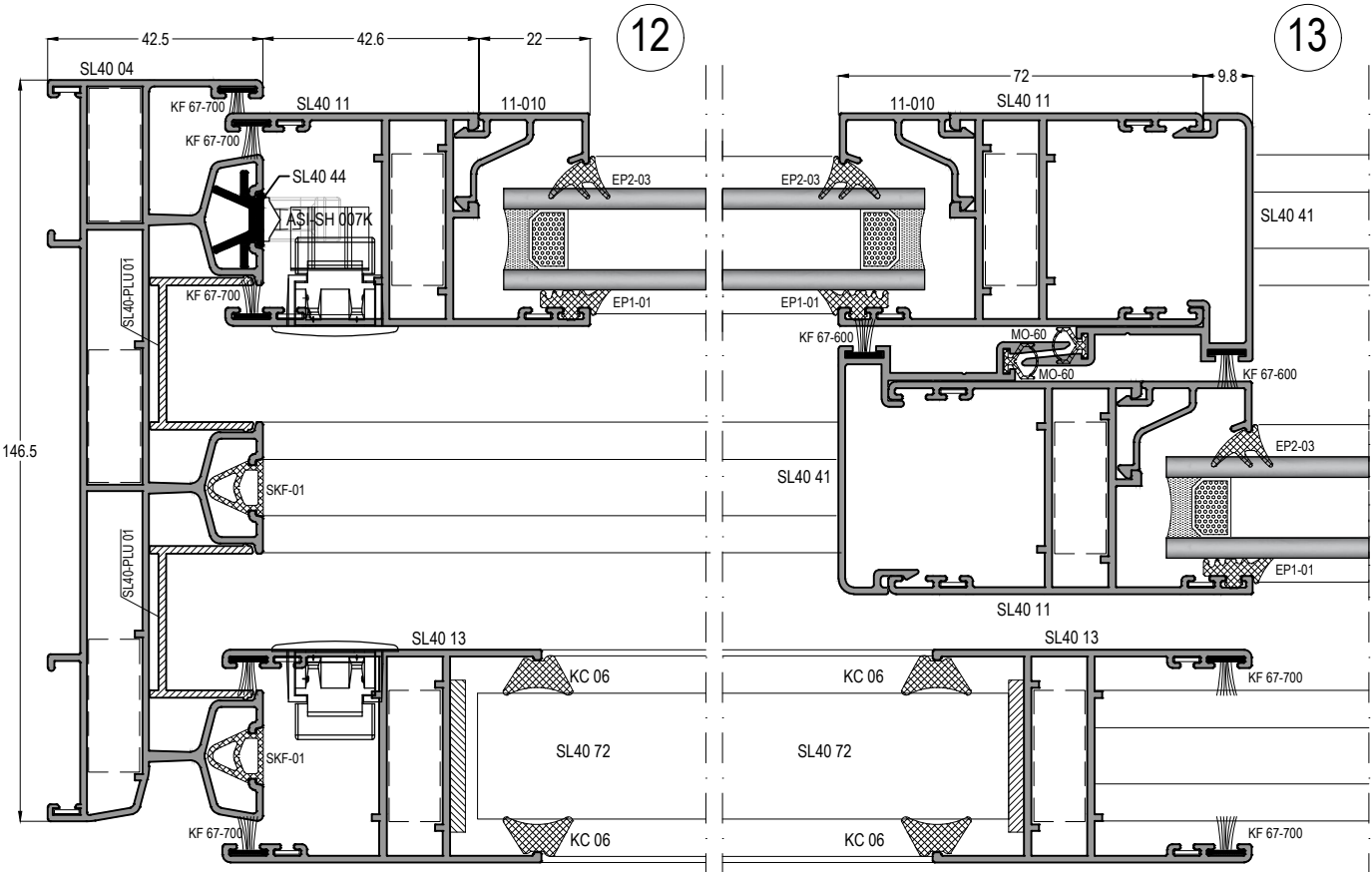

SL40 - 1,4mm

YALITIMSIZ SÜRME SİSTEMİ
UNINSULATED SLIDING SYSTEM

ASISTAL

