

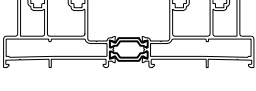









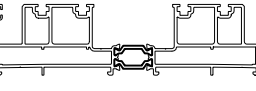

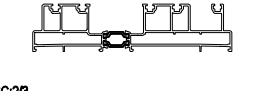

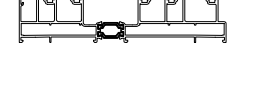
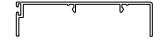
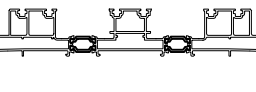

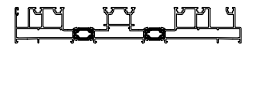
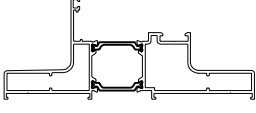
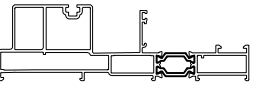
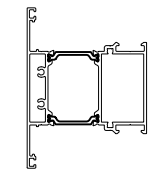
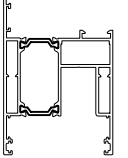

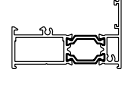

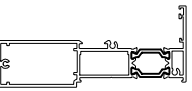
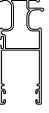







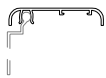

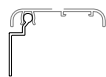

PROFİL VE AKSESUAR LİSTELERİ
PROFILE & ACCESSORIES LIST





PROFİL LİSTESİ - PROFILES LIST

LS70 01			LS70 40		
KASA PROFİLİ FRAME PROFILE	AĞIRLIK / Weight 3,326 kg/mt		KAPAK PROFİLİ COVER PROFILE	AĞIRLIK / Weight 0,694 kg/mt	
LS70 02			LS70 41		
KASA PROFİLİ FRAME PROFILE	AĞIRLIK / Weight 3,534 kg/mt		KENET PROFİLİ CENTRAL LOCKING PROFILE	AĞIRLIK / Weight 0,441 kg/mt	
LS70 03		 sc:23	LS70 42		
İKİLİ KASA PROFİLİ SİNEKLİK RAYLI FRAME PROFILE	AĞIRLIK / Weight 3,847 kg/mt		ADAPTÖR PROFİLİ ADAPTER PROFILE	AĞIRLIK / Weight 1,002 kg/mt	
LS70 04		 sc:23	LS70 43		
İKİLİ KASA PROFİLİ SİNEKLİK RAYLI FRAME PROFILE-FLY SCREEN	AĞIRLIK / Weight 4,054 kg/mt		KAPAK PROFİLİ COVER PROFILE	AĞIRLIK / Weight 0,568 kg/mt	
LS70 05		 sc:23	LS70 44		
KASA PROFİLİ FRAME PROFILE	AĞIRLIK / Weight 5,181 kg/mt		KENET PROFİLİ CENTRAL LOCKING PROFILE	AĞIRLIK / Weight 0,515 kg/mt	
LS70 06		 sc:12	LS70 78		
ÜÇLÜ KASA PROFİLİ SİNEKLİK RAYLI FRAME PROFILE-FLY SCREEN	AĞIRLIK / Weight 5,703 kg/mt		SÜRME SABİT GEÇİŞ PROFİLİ FRAME PROFILE	AĞIRLIK / Weight 2,467 kg/mt	
LS70 08			TH70 23		
KASA PROFİLİ FRAME PROFILE	AĞIRLIK / Weight 2,735 kg/mt		ORTA KAYIT PROFİLİ TRANSOM-MULLION PROFILE	AĞIRLIK / Weight 2,203 kg/mt	
LS70 11			LS60 35		
KANAT PROFİLİ SASH PROFILE	AĞIRLIK / Weight 2,344 kg/mt		KANAT SABİTLEME PROFİLİ SASH FIXING PROFILE	AĞIRLIK / Weight 0,672 kg/mt	
LS70 12			LS70 61		
DAR KANAT PROFİLİ NARROW SASH PROFILE	AĞIRLIK / Weight 1,282 kg/mt		DAMLALIK PROFİLİ COVER PROFILE	AĞIRLIK / Weight 0,231 kg/mt	
LS70 13			13-09986		
DAR KANAT PROFİLİ NARROW SASH PROFILE	AĞIRLIK / Weight 1,961 kg/mt		SİNEKLİK KANAT PROFİLİ FLYSCREEN SASH PROFILE	AĞIRLIK / Weight 0,741 kg/mt	



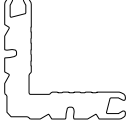















PROFİL LİSTESİ - PROFILES LIST

SL34T-52			11-017		
DAR SİNEKLİK KANAT PROFİLİ FLYSCREEN SASH PROFILE	AĞIRLIK / Weight 0,466 kg/mt		CAM ÇİTASI-17 mm GLAZING BEAD PROFILE	AĞIRLIK / Weight 0,250 kg/mt	
SL32 43			11-020		
PERVAZ MONTAJ PROFİLİ BORDER FIXING PROFILE	AĞIRLIK / Weight 0,235 kg/mt		CAM ÇİTASI-20 mm GLAZING BEAD PROFILE	AĞIRLIK / Weight 0,276 kg/mt	
12-54			11-022		
PERVAZ PROFİLİ BORDER PROFILE	AĞIRLIK / Weight 0,326 kg/mt		CAM ÇİTASI-22 mm GLAZING BEAD PROFILE	AĞIRLIK / Weight 0,282 kg/mt	
12-57			11-026		
PERVAZ PROFİLİ BORDER PROFILE	AĞIRLIK / Weight 0,358 kg/mt		CAM ÇİTASI-26 mm GLAZING BEAD PROFILE	AĞIRLIK / Weight 0,296 kg/mt	
11-52			11-028		
PERVAZ PROFİLİ BORDER PROFILE	AĞIRLIK / Weight 0,279 kg/mt		CAM ÇİTASI-28 mm GLAZING BEAD PROFILE	AĞIRLIK / Weight 0,302 kg/mt	
12-52			11-030		
PERVAZ MONTAJ PROFİLİ BORDER FIXING PROFILE	AĞIRLIK / Weight 0,177 kg/mt		CAM ÇİTASI-30 mm GLAZING BEAD PROFILE	AĞIRLIK / Weight 0,308 kg/mt	
11-004			11-032		
CAM ÇİTASI-4 mm GLAZING BEAD PROFILE	AĞIRLIK / Weight 0,181 kg/mt		CAM ÇİTASI-32 mm GLAZING BEAD PROFILE	AĞIRLIK / Weight 0,315 kg/mt	
11-106			11-035		
CAM ÇİTASI-6 mm GLAZING BEAD PROFILE	AĞIRLIK / Weight 0,200 kg/mt		CAM ÇİTASI-35 mm GLAZING BEAD PROFILE	AĞIRLIK / Weight 0,323 kg/mt	
11-010			11-038		
CAM ÇİTASI-10 mm GLAZING BEAD PROFILE	AĞIRLIK / Weight 0,233 kg/mt		CAM ÇİTASI-38 mm GLAZING BEAD PROFILE	AĞIRLIK / Weight 0,334 kg/mt	
11-015			10-010106-00		
CAM ÇİTASI-15 mm GLAZING BEAD PROFILE	AĞIRLIK / Weight 0,242 kg/mt		KÖŞE TAKOZU-10,6 mm CORNER JOINT	AĞIRLIK / Weight 2,653 kg/mt	



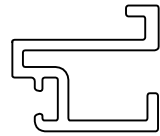

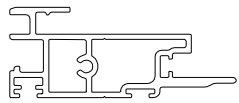

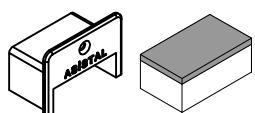
PROFİL LİSTESİ - PROFILE LIST

10-010140-00				
KÖŞE TAKOZU-14,2 mm CORNER JOINT	AĞIRLIK / Weight 3,582 kg/mt			
10-010225-00				
KÖŞE TAKOZU-22,5 mm CORNER JOINT	AĞIRLIK / Weight			
LS60 71				
KÖŞE TAKOZU-14,2 mm CORNER JOINT	AĞIRLIK / Weight 2,050 kg/mt			
LS60 72				
KÖŞE TAKOZU-22,5 mm CORNER JOINT	AĞIRLIK / Weight 0,420 kg/mt			

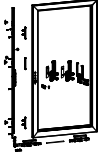
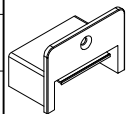
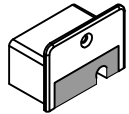
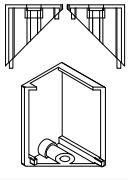
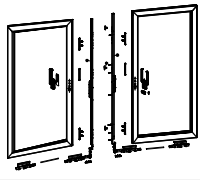
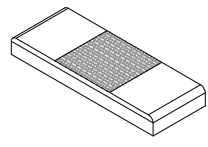

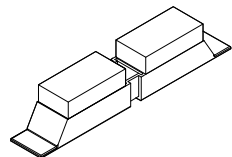
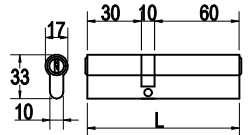
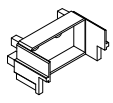

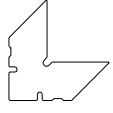
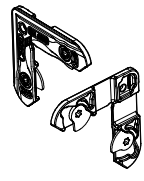
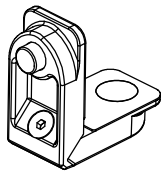
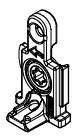
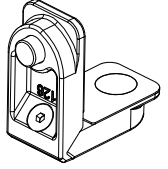
AKSESUAR LİSTESİ - ACCESSORIES LIST

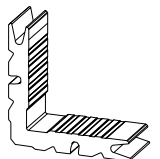
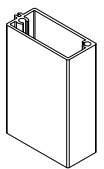
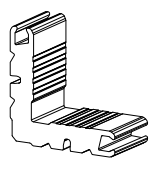
EP1-01			TRI-FIN-700		
DİŞ CAM FİTİLİ - 2,5 mm OUTER GLAZING GASKET	KOLİ MİKTARI/Package 240 mt / 15 kg		3 YAPRAKLI KIL FİTİL -7mm TRI-BRUSH GASKET	KOLİ MİKTARI/Package 400 mt / koli	
EP2-01			KF 67-600		
İÇ CAM FİTİLİ - 3 mm INNER GLAZING GASKET	KOLİ MİKTARI/Package 440 mt / 15 kg		FIRÇA FİTİL-6mm BRUSH GASKET	KOLİ MİKTARI/Package 1300 mt / koli	
EP2-02			KF 67-700		
İÇ CAM FİTİLİ - 4 mm INNER GLAZING GASKET	KOLİ MİKTARI/Package 300 mt / 15 kg		FIRÇA FİTİL-7mm BRUSH GASKET	KOLİ MİKTARI/Package 1100 mt / koli	
EP2-03			KF 67-1000		
İÇ CAM FİTİLİ - 5 mm INNER GLAZING GASKET	KOLİ MİKTARI/Package 250 mt / 15 kg		FIRÇA FİTİL-10mm BRUSH GASKET	KOLİ MİKTARI/Package 600 mt / koli	
EP38-02			MO70-03		
KASA KANAL FİTİLİ FRAME GASKET	KOLİ MİKTARI/Package 535 mt / 15 kg		MO70-10 İÇİN KAPAK-ALT COVER FOR MO60-10-BOTTOM	KOLİ MİKTARI/Package Adet / Piece	
EP70-02			MO70-04		
KASA FİTİLİ FRAME GASKET	KOLİ MİKTARI/Package 500 mt / 15 kg		MO70-10 İÇİN KAPAK-ÜST COVER FOR MO60-10-TOP	KOLİ MİKTARI/Package Adet / Piece	
EP38 -01			MO70-08		
KANAT FİTİLİ SASH GASKET	KOLİ MİKTARI/Package 500 mt / 15 kg		KASA YALITIM PVC FRAME ISOLATION GASKET	KOLİ MİKTARI/Package 6 mt / Adet	
C60-04			MO70-09		
KANAL FİTİLİ ADAPTER GASKET- 480.AL.M.S	KOLİ MİKTARI/Package 100 mt / 15 kg		DAR ORTA KENET YALITIM FİTİLİ - PVC CENTRAL LOCKING SEALING GASKET-PVC	KOLİ MİKTARI/Package 6 mt / Adet	
EP60-04			MO70-10		
KENET FİTİLİ CENTRAL LOCKING GASKET	KOLİ MİKTARI/Package 300 mt / koli		ORTA KENET YALITIM FİTİLİ - PVC CENTRAL LOCKING SEALING GASKET-PVC	KOLİ MİKTARI/Package 6 mt / Adet	
EP70-03			MO70-01		
SABİT ÇITA FİTİLİ Fixed Frame Gasket	KOLİ MİKTARI/Package - mt / koli		KENET KAPAĞI INTERLOCK ADAPTOR FOAM	KOLİ MİKTARI/Package Adet / Piece	

AKSESUAR LİSTESİ - ACCESSORIES LIST

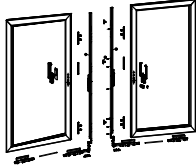
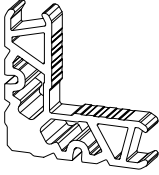
MO70-TB1		TOP	BOTTOM	LS60-MEK2		
90°DAR KENET KAPAĞI LS70-12/LS7013 NORROW INTERLOCK ADAPTOR, FOAM	KOLİ MİKTARI/Package Takım / Set			200 kg KAPASİTELİ KALDIR-SÜR MEKANİZMA LIFT & SLIDE MECHANISM	KOLİ MİKTARI/Package Takım / Set	
MO70-INT 01				LS60-MEK2D		
90°DAR KENET KAPAK TAKIMI - LS7013 COVER	KOLİ MİKTARI/Package Takım / Set			200 kg KAPASİTELİ 4'LÜ KANAT MEKANİZMA LIFT & SLIDE MECHANISM	KOLİ MİKTARI/Package Takım / Set	
MO70-05				ASI-LS-H01		
HAVA KESİCİ CENTRAL SEALING-TOP	KOLİ MİKTARI/Package Adet / Piece			KALDIR-SÜR KOLU LIFT&SLIDE HANDLE	KOLİ MİKTARI/Package Takım / Set	
MO60-05D				ASI-BRL 100		
ALT HAVA KESİCİ LS70 08 KASA İÇİN CENTRAL SEALING-BOTTOM FOR LS70 08	KOLİ MİKTARI/Package Adet / Piece			100 LUK BAREL CYLINDER 100	KOLİ MİKTARI/Package Adet / Piece	
MO70-12				ASI-SB 19.1		
4 LÜ KANAT KİLİTLEME ADAPTÖR KAPAĞI MEETING STILE CAP	KOLİ MİKTARI/Package Adet / Piece			KÖŞE GÖNYESİ CORNER ALIGNMENT	KOLİ MİKTARI/Package 1000 Adet / Piece	
ASI-WDC 01				ASI-SB 34		
YAĞMUR TAHLİYE KAPAĞI WATER REJECT COVER	KOLİ MİKTARI/Package Adet / Piece			KÖŞE GÖNYESİ CORNER ALIGNMENT	KOLİ MİKTARI/Package 1000 Adet / Piece	
ASI-FUJI 2500				ASI-PB 1119		
AYARLI ORTA KAYIT BAĞLANTI T JOINT CONNECTION	KOLİ MİKTARI/Package Adet / Piece			PİMLİ KÖŞE BAĞLANTI CORNER JOINT	KOLİ MİKTARI/Package Adet / Piece	
ASI-FUJI 2700				ASI-PB 1126		
AYARLI ORTA KAYIT BAĞLANTI T JOINT CONNECTION	KOLİ MİKTARI/Package Adet / Piece			PİMLİ KÖŞE BAĞLANTI CORNER JOINT	KOLİ MİKTARI/Package Adet / Piece	
MO60-19				ASI-KT 1126		
KOL PROFİL KAPAĞI HANDLE PROFILE CAP	KOLİ MİKTARI/Package alt-üst takım / set			KÖŞE TAKOZU CORNER JOINT	KOLİ MİKTARI/Package Adet / Piece	
LS60-DB 3560				ASI-KT 1429		
KANAT SABİTLEME PARÇASI SASH FIXING	KOLİ MİKTARI/Package Adet / Piece			KÖŞE TAKOZU CORNER JOINT	KOLİ MİKTARI/Package Adet / Piece	

AKSESUAR LİSTESİ - ACCESSORIES LIST

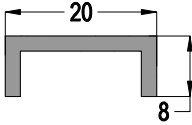
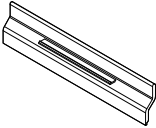
LS60-MEK1				
300 kg KAPASİTELİ KALDIR-SÜR MEKANİZMA <i>LIFT & SLIDE MECHANISM</i>	KOLİ MİKTARI/Package Takım / Set			
LS60-MEK1D				
300 kg KAPASİTELİ 4'LÜ KANAT MEKANİZMA <i>LIFT & SLIDE MECHANISM</i>	KOLİ MİKTARI/Package Takım / Set			
ASI-KT 2307				
KÖŞE TAKOZU <i>CORNER JOINT</i>	KOLİ MİKTARI/Package Adet / Piece			
ASI-INR 02				
ÇELİK RAY <i>STEEL RAIL</i>	KOLİ MİKTARI/Package 6 mt / Adet			
ASI-5025				
SİNEKLİK FİTİLİ <i>FLYSCREEN GASKET</i>	KOLİ MİKTARI/Package 100 mt			
ASI-SR 01R				
AYARLI TEKLİ RULMAN (V TİPİ RAY İÇİN) <i>SINGLE SLIDING ROLLER FOR RAIL TYPE - V</i>	KOLİ MİKTARI/Package Adet / Piece			
LS70-DB2008				
KASA MONTAJ PARÇASI <i>FRAME ASSEMBLY PART</i>	KOLİ MİKTARI/Package Adet / Piece			
MO70-13				
KANAT DENGELEME PLASTİĞİ <i>SASH STABILIZATION SPACER</i>	KOLİ MİKTARI/Package Adet / Piece			

LS70 - 1,8mm

YALITIMLI KALDIR-SÜR SİSTEMİ
THERMAL LIFT&SLIDE SYSTEM

ASISTAL

PROFİL DETAYLARI
PROFILE DETAILS

LS70 - 1,8mm

YALITIMLI KALDIR-SÜR SİSTEM
THERMAL LIFT&SLIDE SYSTEM

ASISTAL

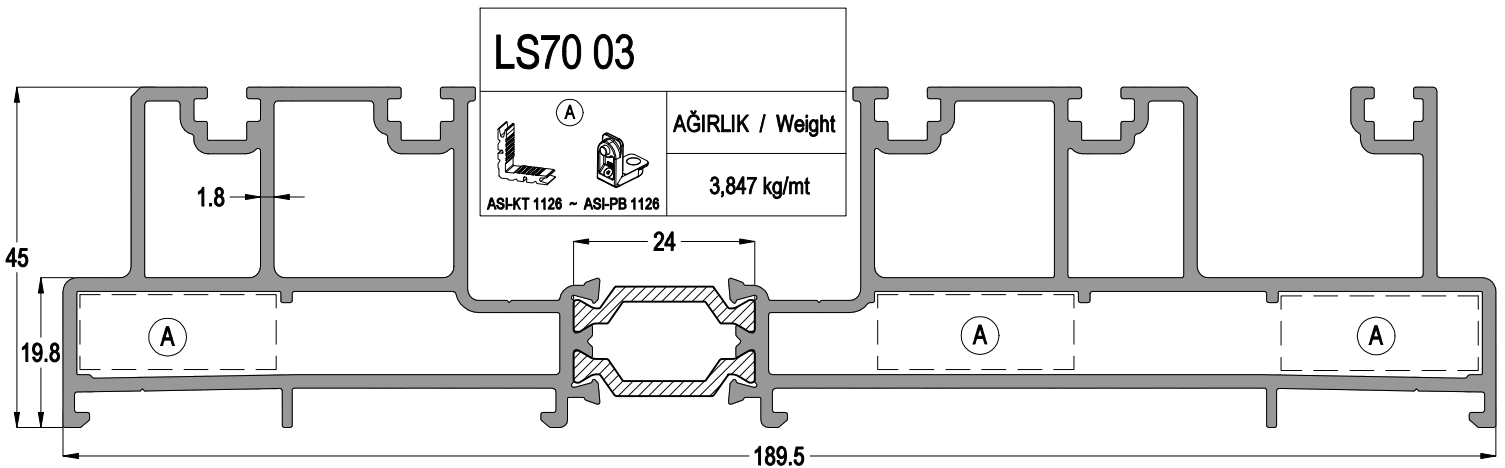
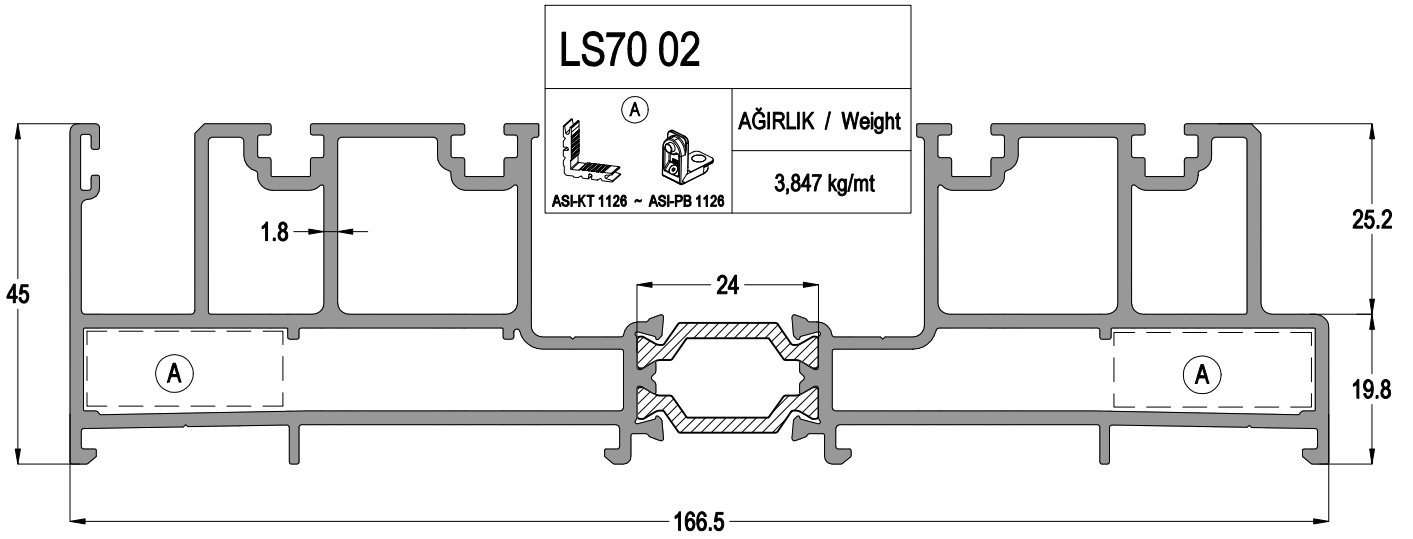
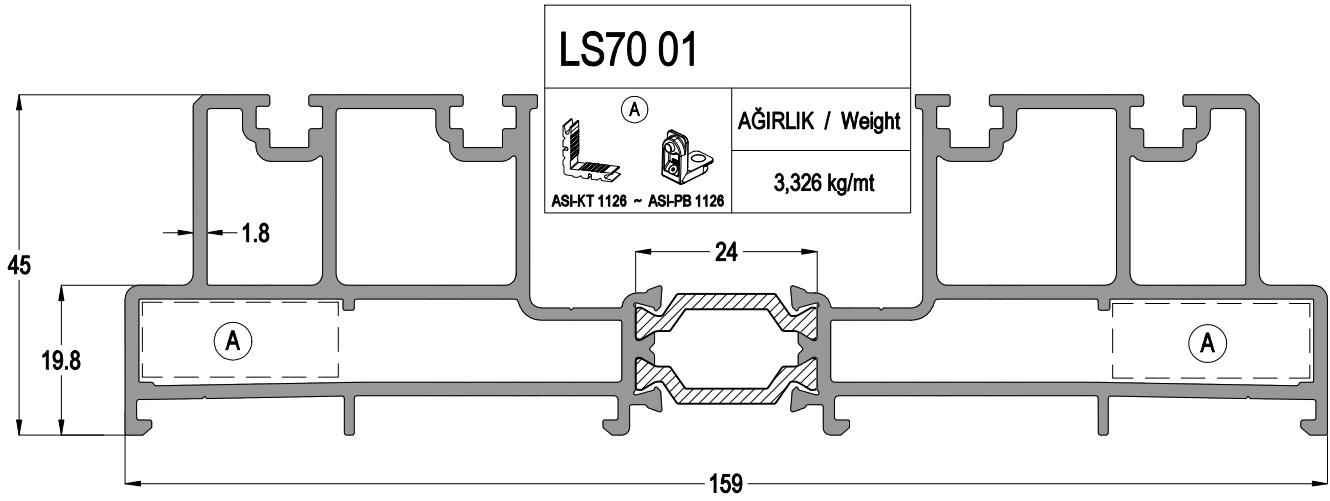

Profil ağırlıklarımız teorik olup; teslim anındaki tartımız geçerlidir.
Profile weights are theoretical and the weight at the time of delivery is valid.

LS70 - 1,8mm

YALITIMLI KALDIR-SÜR SİSTEM
THERMAL LIFT&SLIDE SYSTEM



LS70 04

 ASI-KT 1126 ~ ASI-PB 1126	AĞIRLIK / Weight 4,054 kg/mt
--	---------------------------------

LS70 05

 ASI-KT 1126 ~ ASI-PB 1126	AĞIRLIK / Weight 5,181 kg/mt
---	---------------------------------

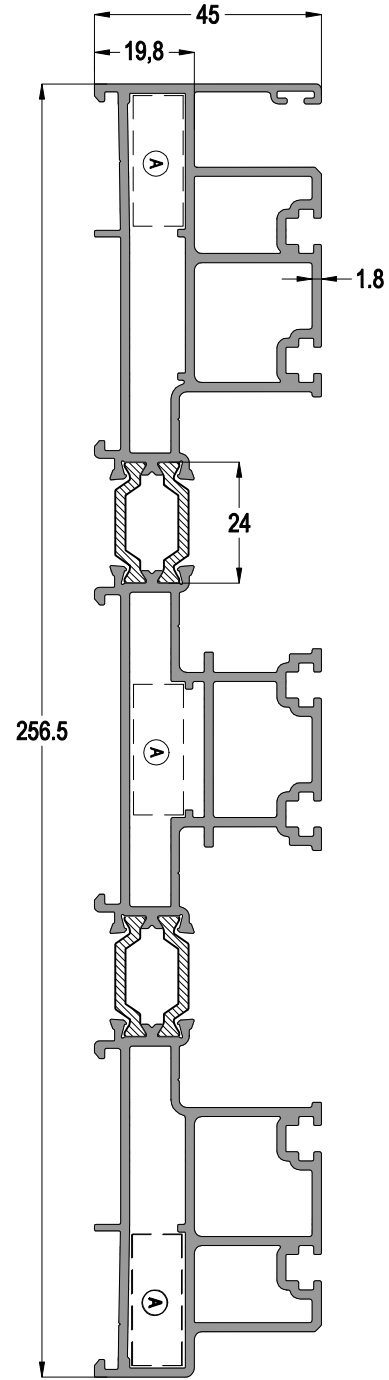
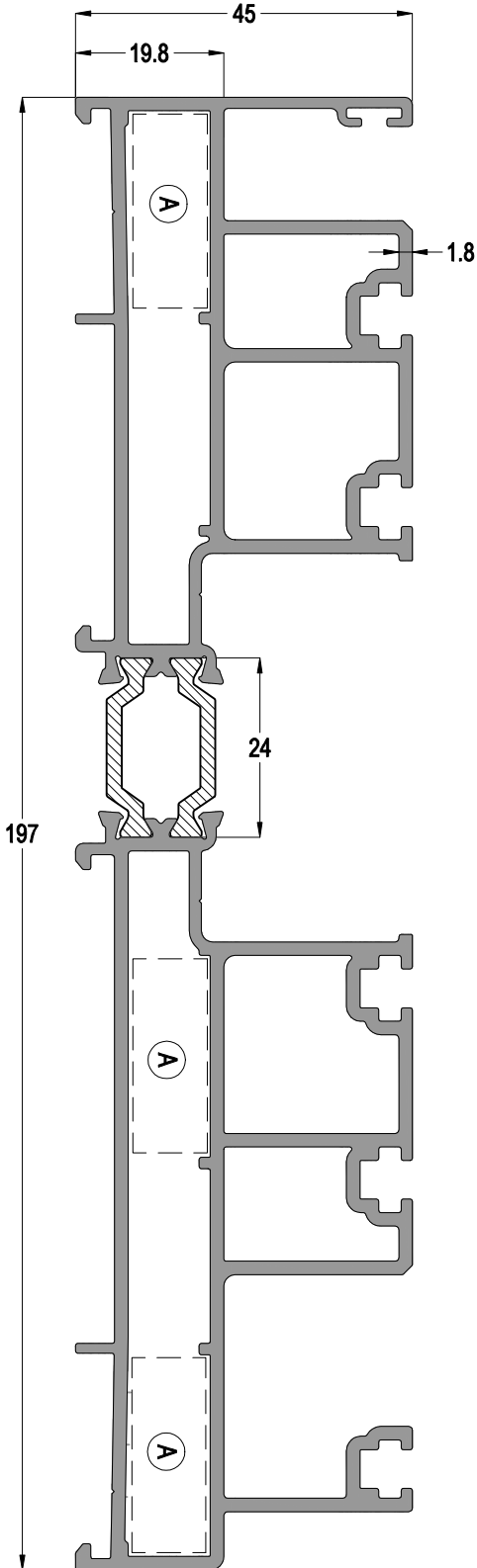

SC:2/3

Profil ağırlıklarımız teorik olup; teslim anındaki tartımız geçerlidir.
Profile weights are theoretical and the weight at the time of delivery is valid.

LS70 - 1,8mm

YALITIMLI KALDIR-SÜR SİSTEM
THERMAL LIFT&SLIDE SYSTEM

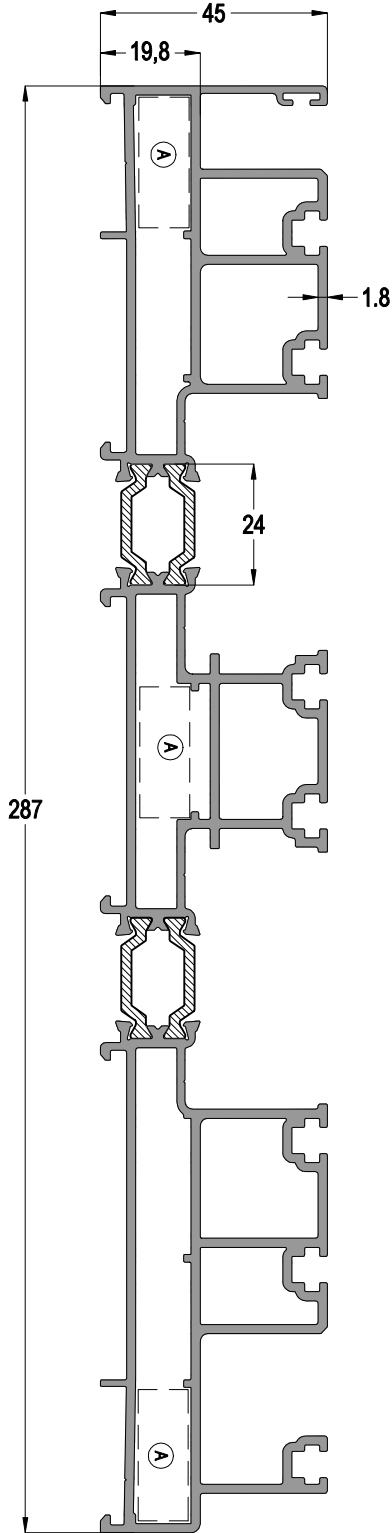

LS70 06

 ASI-KT 1126 ~ ASI-PB 1126	AĞIRLIK / Weight 5,703 kg/mt
--	--



SC:2/3

LS70 11

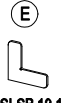
 ASI-KT 1429	 ASI-KT 2307	 ASI-SB 19.1	AĞIRLIK / Weight 2,314 kg/mt
---	--	--	--

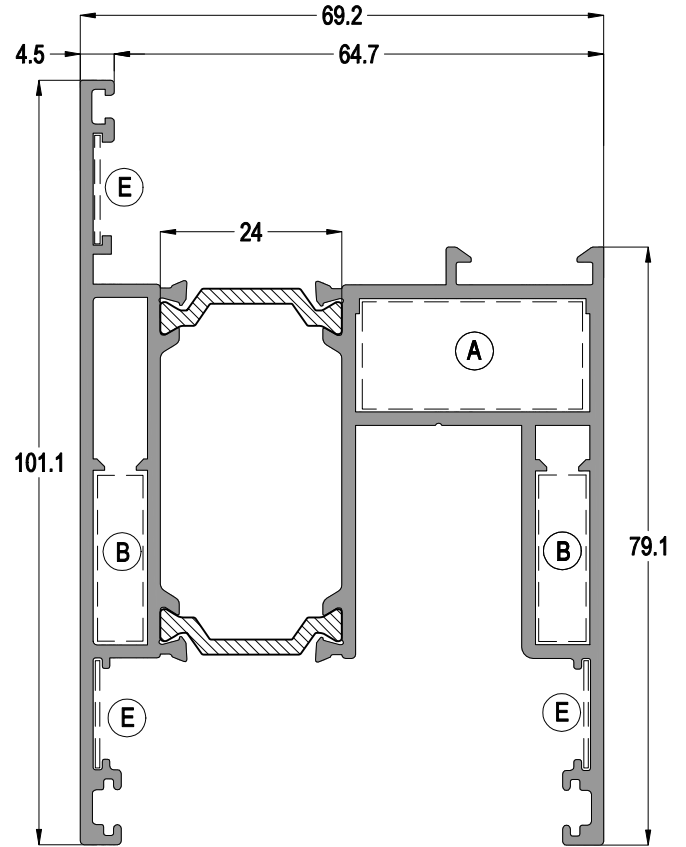

LS70 08

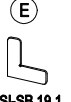
 ASI-KT 1126 ~ ASI-PB 1126	 ASI-SB 19.1	AĞIRLIK / Weight 2,735 kg/mt
---	--	--

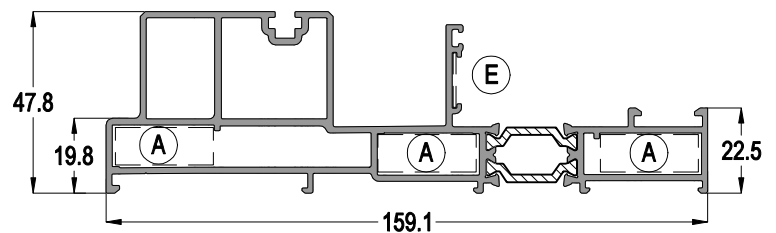

SC:1/2



Profil ağırlıklarımız teorik olup; teslim anındaki tartımız geçerlidir.
Profile weights are theoretical and the weight at the time of delivery is valid.

LS70 - 1,8mm

YALITIMLI KALDIR-SÜR SİSTEM
THERMAL LIFT&SLIDE SYSTEM

ASISTAL

LS70 12

			AĞIRLIK / Weight
ASI-KT 1126 ~ ASI-PB 1126	ASI-KT 1106	ASI-SB 19.1	1,282 kg/mt

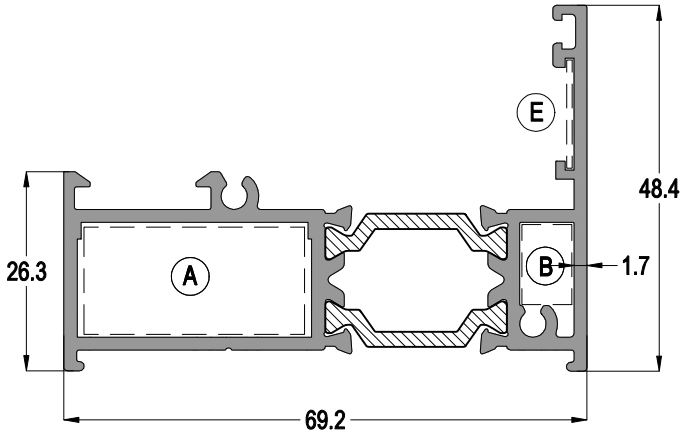

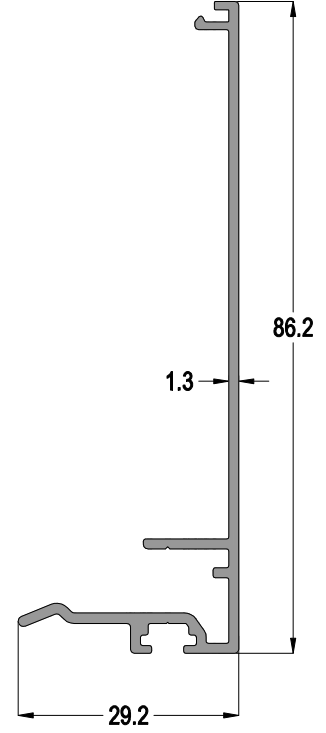

LS70 44

0,515 kg/mt



LS70 13

			AĞIRLIK / Weight
ASI-KT 1126 ~ ASI-PB 1126	ASI-KT 1106	ASI-SB 19.1	1,961 kg/mt

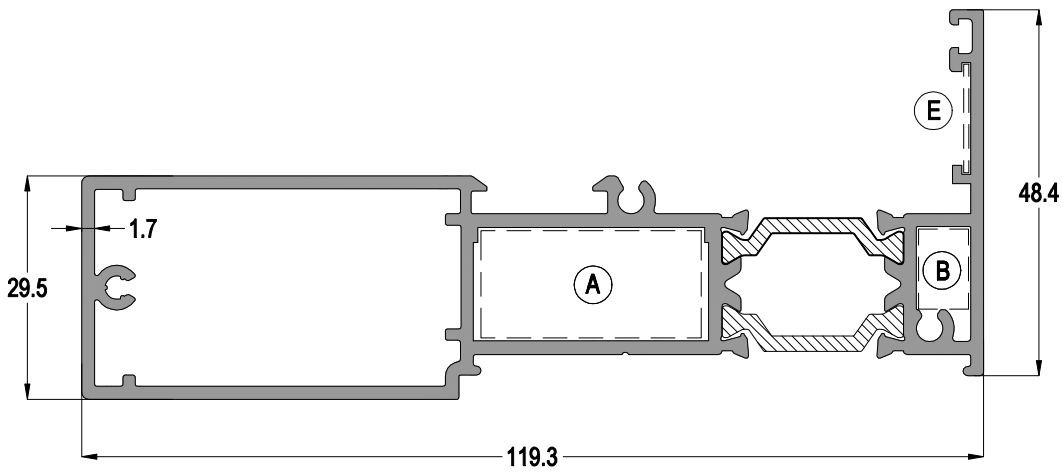

Profil ağırlıklarımız teorik olup; teslim anındaki tartımız geçerlidir.
Profile weights are theoretical and the weight at the time of delivery is valid.

LS70 - 1,8mm

YALITIMLI KALDIR-SÜR SİSTEM
THERMAL LIFT&SLIDE SYSTEM

ASISTAL

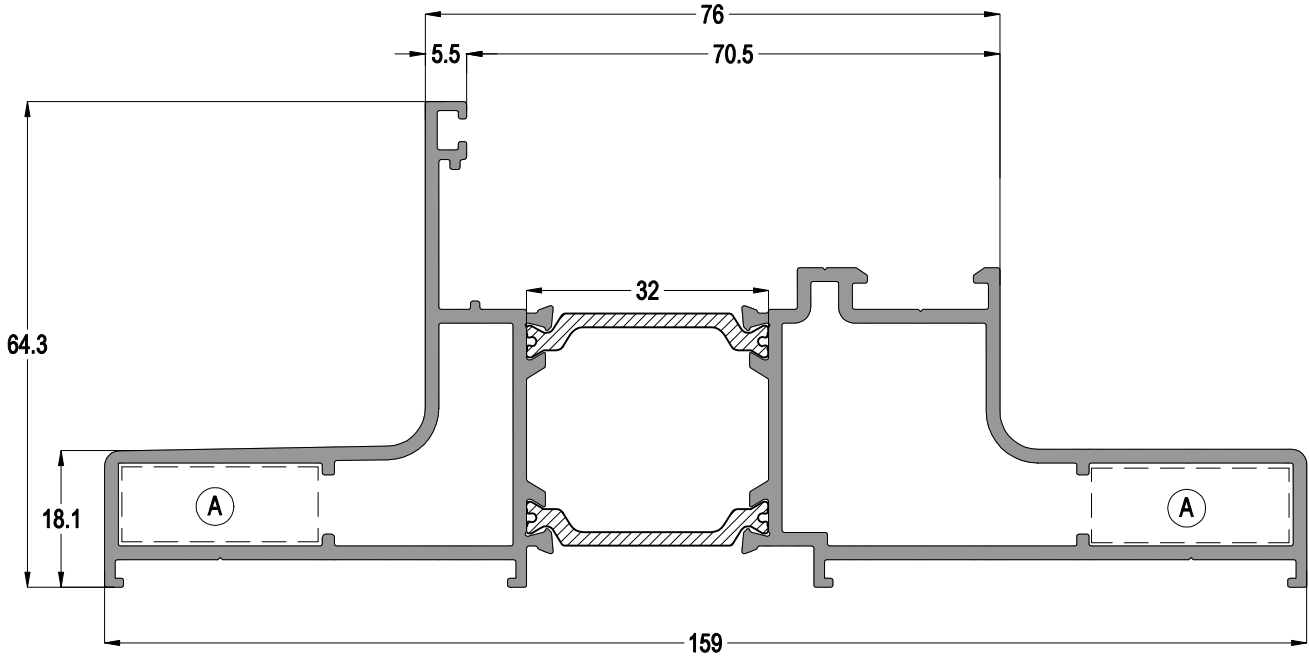

LS70 78

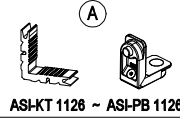

AĞIRLIK / Weight

2,467 kg/mt

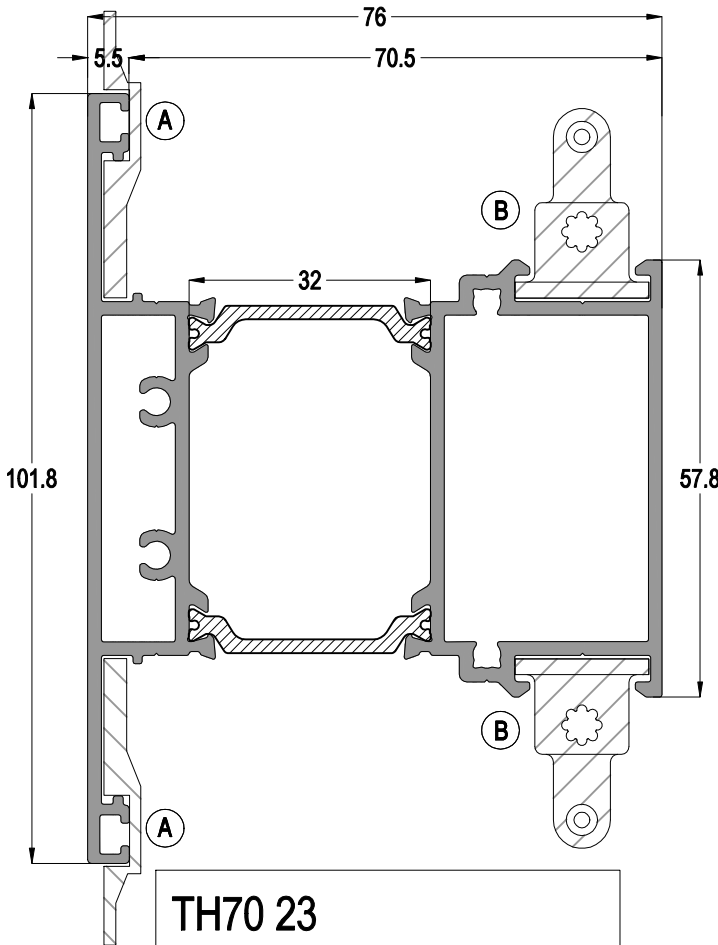

TH70 23



AĞIRLIK / Weight

2,203 kg/mt

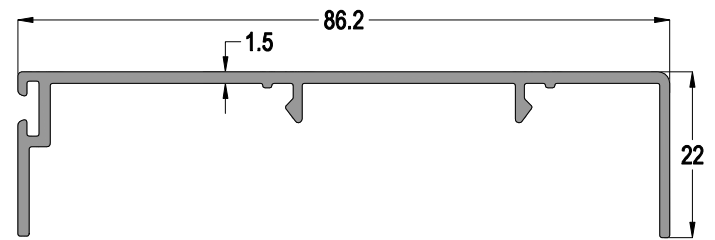

TH70 43

AĞIRLIK / Weight

0,568 kg/mt

Profil ağırlıklarımız teorik olup; teslim anındaki tartımız geçerlidir.
Profile weights are theoretical and the weight at the time of delivery is valid.

LS70 - 1,8mm

YALITIMLI KALDIR-SÜR SİSTEM
THERMAL LIFT&SLIDE SYSTEM

ASISTAL

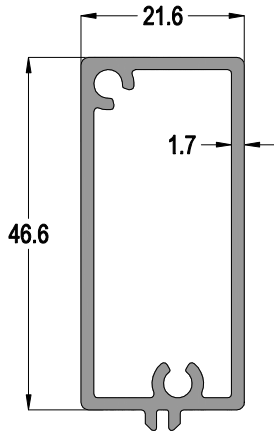

LS60 35

0,672 kg/mt

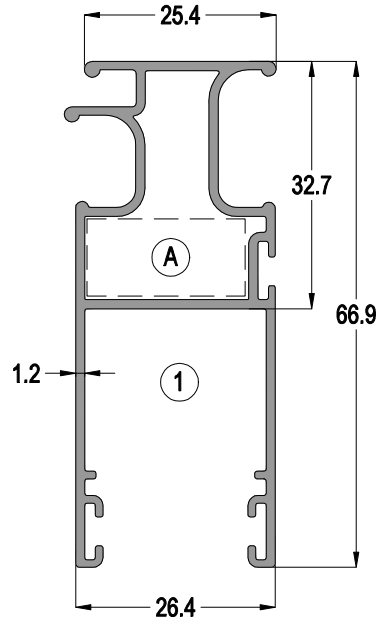

13-09986



ASI-PB 1119

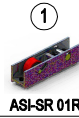

ASI-SR 01R

AĞIRLIK / Weight

0,741 kg/mt

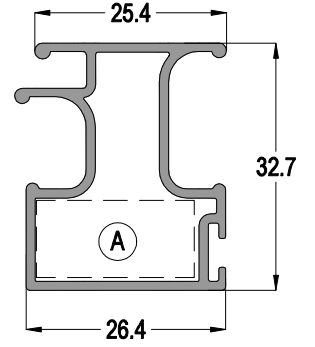

SL34T-52



ASI-PB 1119

AĞIRLIK / Weight

0,466 kg/mt

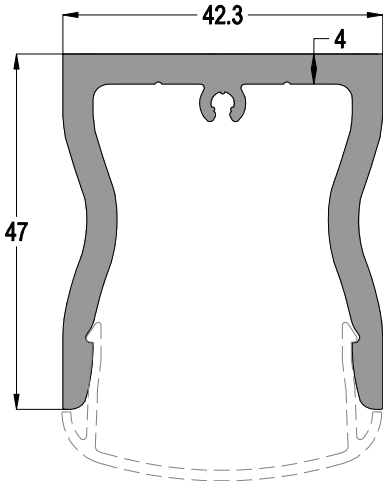

LS60 71



MO60-19

AĞIRLIK / Weight

2,050 kg/mt

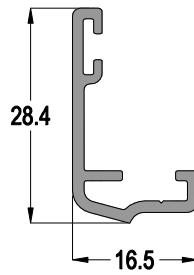

LS70 61

0,231 kg/mt

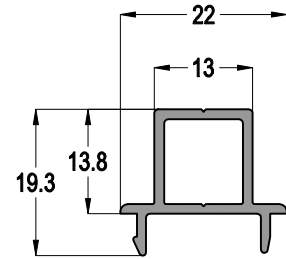

SL32 43

0,235 Kg/mt

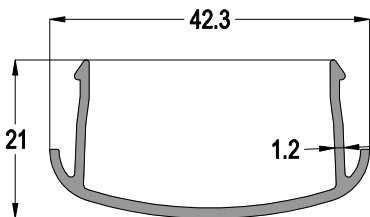

LS60 72

0,420 kg/mt

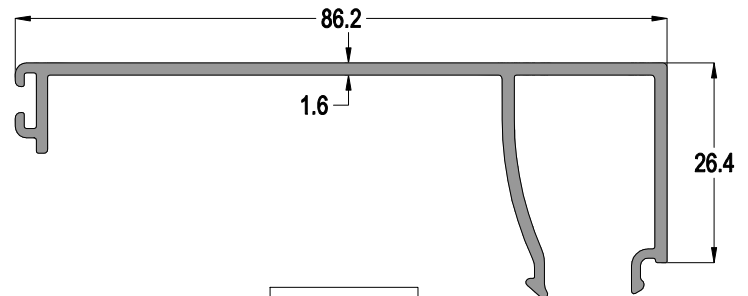

LS70 40

0,694 kg/mt

Profil ağırlıklarımız teorik olup; teslim anındaki tartımız geçerlidir.
Profile weights are theoretical and the weight at the time of delivery is valid.

LS70 - 1,8mm

YALITIMLI KALDIR-SÜR SİSTEM
THERMAL LIFT&SLIDE SYSTEM

ASISTAL

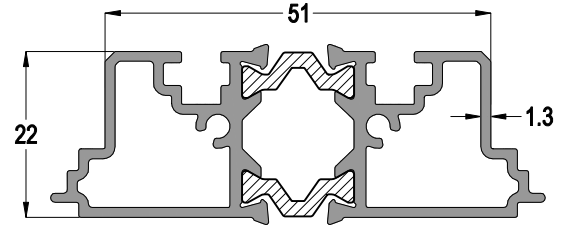
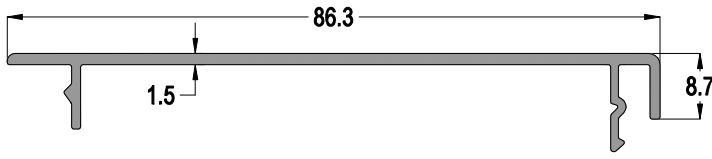

LS70 41

AĞIRLIK / Weight
0,441 kg/mt

LS70 42

AĞIRLIK / Weight
1,001 kg/mt

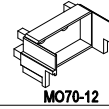

MO70-12

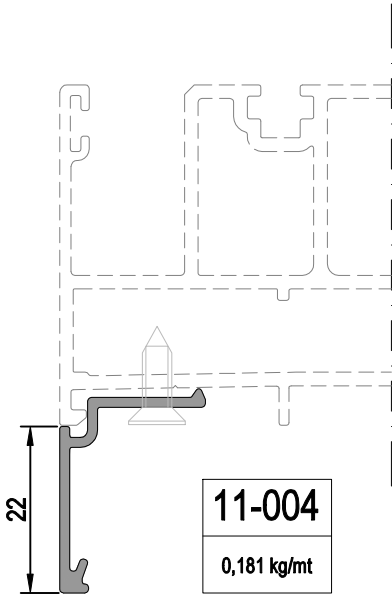

11-004

0,181 kg/mt

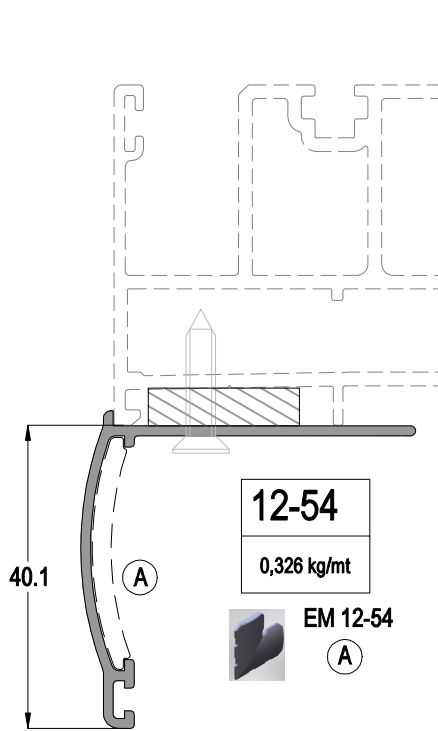

12-54

0,326 kg/mt



EM 12-54

A

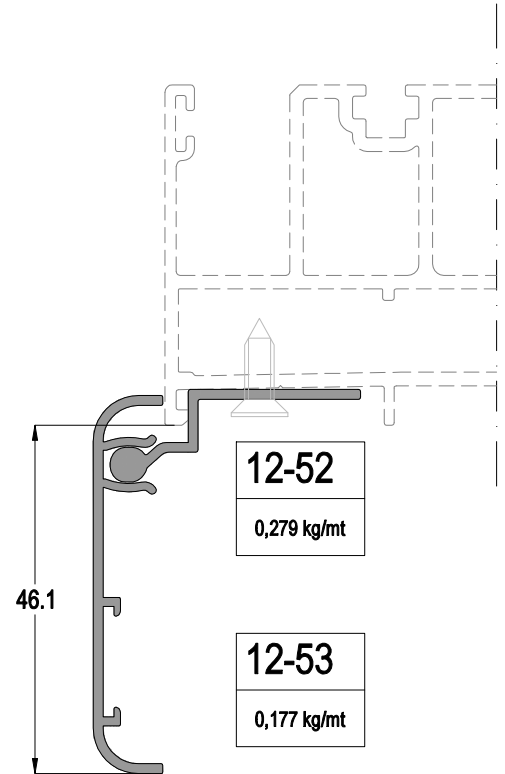

12-52

0,279 kg/mt

12-53

0,177 kg/mt

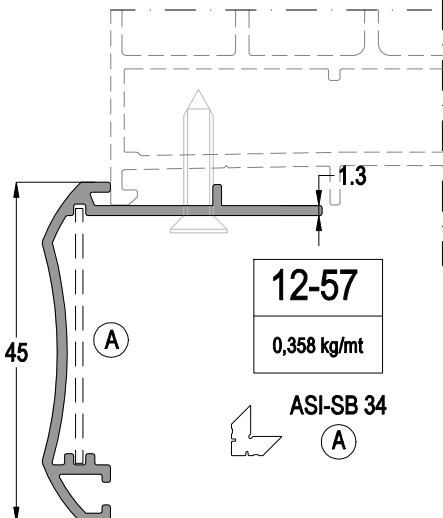

12-57

0,358 kg/mt

ASI-SB 34

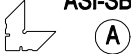

A

Profil ağırlıklarımız teorik olup; teslim anındaki tartımız geçerlidir.
Profile weights are theoretical and the weight at the time of delivery is valid.

LS70 - 1,8mm

YALITIMLI KALDIR-SÜR SİSTEM
THERMAL LIFT&SLIDE SYSTEM

ASISTAL

11-106

0,200 kg/mt

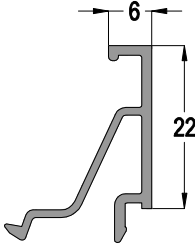

11-010

0,233 kg/mt

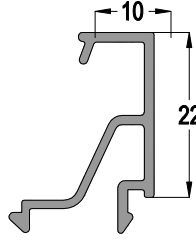

11-015

0,241 kg/mt

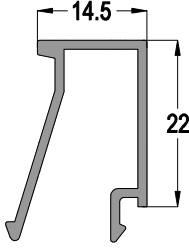

11-017

0,250 kg/mt

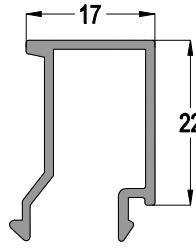

11-020

0,276 kg/mt

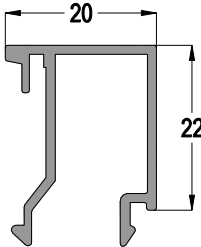

11-022

0,282 kg/mt

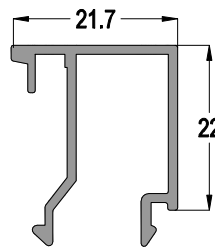

11-026

0,296 kg/mt

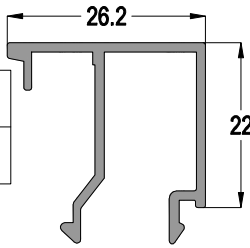

11-028

0,302 kg/mt

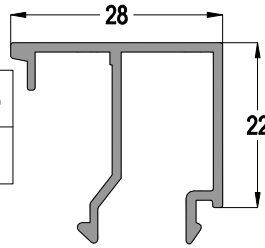

11-030

0,308 kg/mt

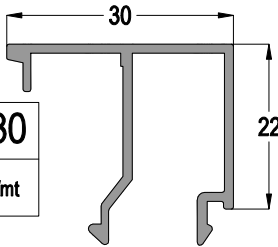

11-032

0,315 kg/mt

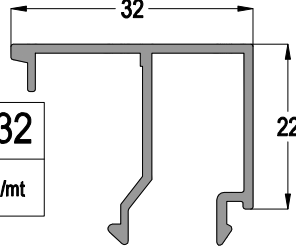

11-035

0,323 kg/mt

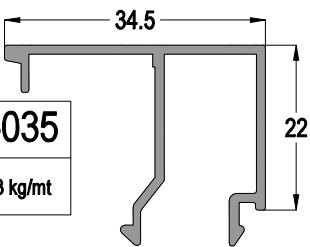

11-038

0,334 kg/mt

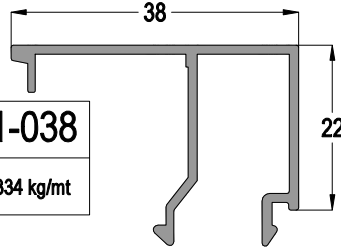

CAM KALINLIĞINA GÖRE CAM ÇİTASI SEÇİM TABLOSU
Glazing Bead Selection Table according to the Glass Thickness (LS70-11)

CAM KALINLIĞI Glass Thickness (mm)	CAM ÇİTASI Glazing Bead	İÇ CAM FİTLİ Glass Gasket (IN)	DIŞ CAM FİTLİ Glass Gasket (OUT)
18	11-038	EP2-03	EP1-01
19	11-038	EP2-02	EP1-01
20	11-038	EP2-01	EP1-01
21	11-035	EP2-03	EP1-01
22	11-035	EP2-02	EP1-01
23	11-035	EP2-01	EP1-01
24	11-032	EP2-03	EP1-01
25	11-032	EP2-02	EP1-01
26	11-032	EP2-01	EP1-01
27	11-030	EP2-02	EP1-01
28	11-030	EP2-01	EP1-01
29	11-028	EP2-02	EP1-01
30	11-028	EP2-01	EP1-01
31	11-026	EP2-02	EP1-01
32	11-026	EP2-01	EP1-01
34	11-022	EP2-03	EP1-01
35	11-022	EP2-02	EP1-01
36	11-022	EP2-01	EP1-01
38	11-020	EP2-01	EP1-01
39	11-017	EP2-03	EP1-01
40	11-017	EP2-02	EP1-01
42	11-015	EP2-02	EP1-01
43	11-015	EP2-01	EP1-01
46	11-010	EP2-03	EP1-01
47	11-010	EP2-02	EP1-01
48	11-010	EP2-01	EP1-01
50	11-006	EP2-03	EP1-01
52	11-006	EP2-01	EP1-01

Profil ağırlıklarımız teorik olup; teslim anındaki tartımız geçerlidir.
Profile weights are theoretical and the weight at the time of delivery is valid.

LS70 - 1,8mm

YALITIMLI KALDIR-SÜR SİSTEM
THERMAL LIFT&SLIDE SYSTEM

ASISTAL

11-010

0,233 kg/mt

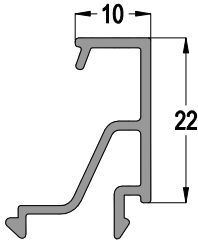

11-015

0,242 kg/mt

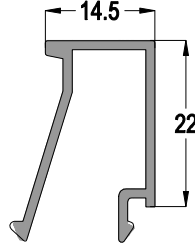

11-017

0,250 kg/mt

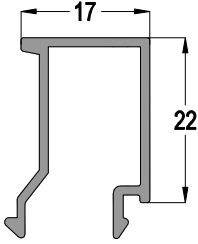

11-020

0,276 kg/mt

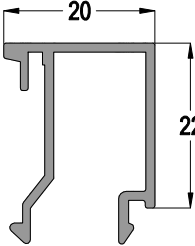

11-022

0,282 kg/mt

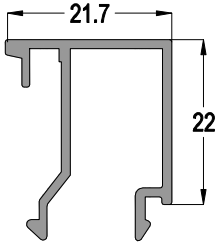

11-026

0,296 kg/mt

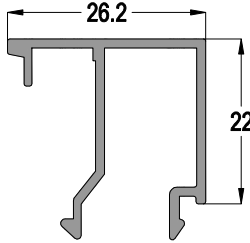

11-028

0,302 kg/mt

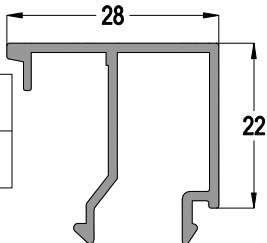

11-030

0,308 kg/mt

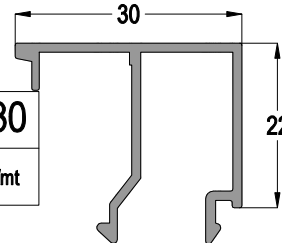

11-032

0,315 kg/mt

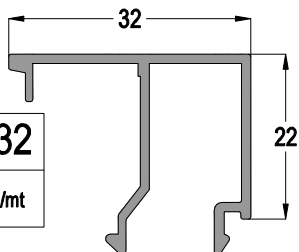

11-035

0,323 kg/mt

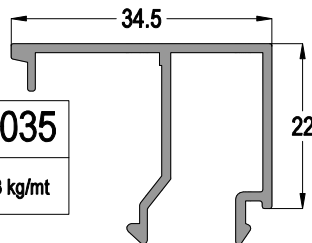

11-038

0,334 kg/mt

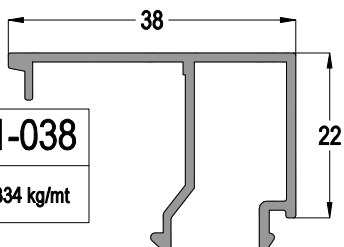

11-144

0,339 kg/mt

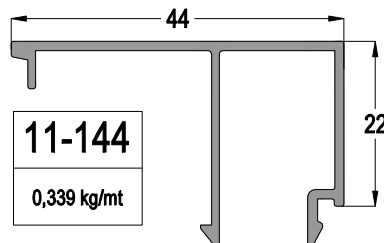

CAM KALINLIĞINA GÖRE CAM ÇİTASI SEÇİM TABLOSU
Glazing Bead Selection Table according to the Glass
Thickness (TH70 23-TH7018)

CAM KALINLIĞI Glass Thickness (mm)	CAM ÇİTASI Glazing Bead	İÇ CAM FITİLİ Glass Gasket (IN)	DIŞ CAM FITİLİ Glass Gasket (OUT)
18	11-044	EP2-03	EP1-01
19	11-044	EP2-02	EP1-01
20	11-044	EP2-01	EP1-01
24	11-038	EP2-03	EP1-01
25	11-038	EP2-02	EP1-01
26	11-038	EP2-01	EP1-01
27	11-035	EP2-03	EP1-01
28	11-035	EP2-02	EP1-01
29	11-035	EP2-01	EP1-01
30	11-032	EP2-03	EP1-01
31	11-032	EP2-02	EP1-01
32	11-032	EP2-01	EP1-01
33	11-030	EP2-02	EP1-01
34	11-030	EP2-01	EP1-01
35	11-028	EP2-02	EP1-01
36	11-026	EP2-02	EP1-01
37	11-026	EP2-01	EP1-01
40	11-022	EP2-03	EP1-01
41	11-022	EP2-02	EP1-01
42	11-022	EP2-01	EP1-01
44	11-020	EP2-01	EP1-01
46	11-017	EP2-02	EP1-01
48	11-015	EP2-02	EP1-01
52	11-010	EP2-03	EP1-01

Profil ağırlıklarımız teorik olup; teslim anındaki tartımız geçerlidir.
Profile weights are theoretical and the weight at the time of delivery is valid.

LS70 - 1,8mm

YALITIMLI KALDIR-SÜR SİSTEMİ
THERMAL LIFT&SLIDE SYSTEM



AÇILIM TİPLERİ KALDIR-SÜR SÜRME - OPENING TYPES LIFT & SLIDING

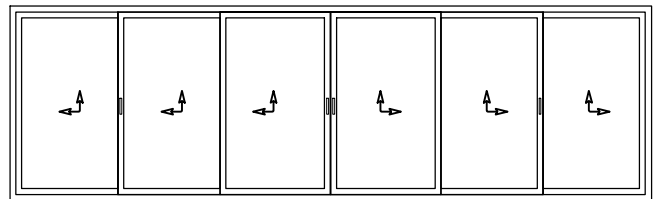
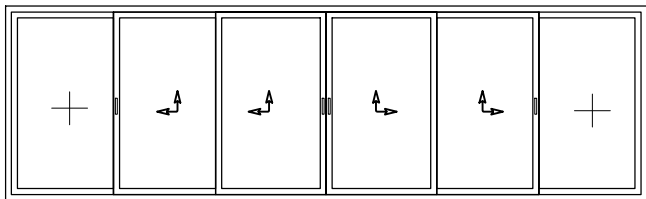
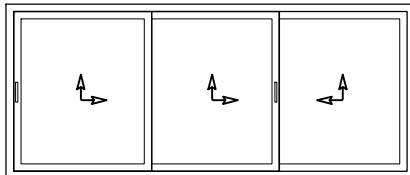
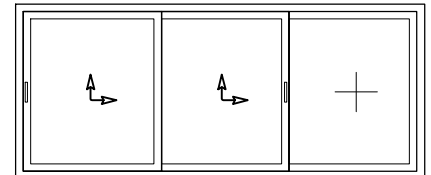
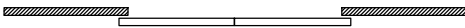
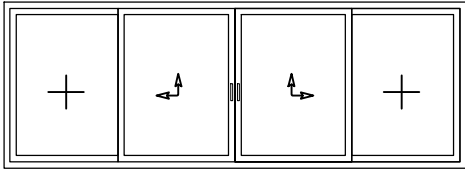
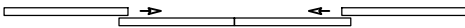
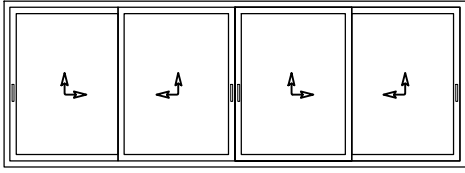
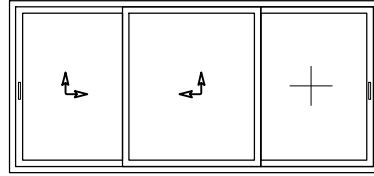
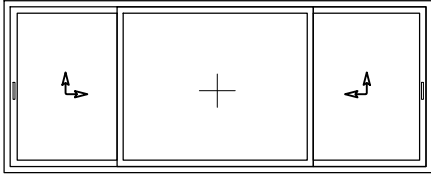
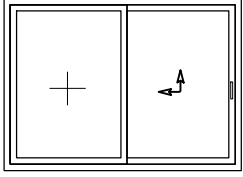
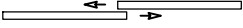
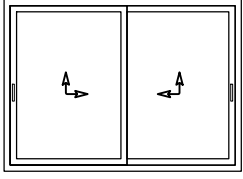

RÜZGAR YÜKÜNE GÖRE MAKSİMUM KANAT EBATLARI
MAXIMUM SASH DIMENSIONS FOR GIVEN WIND PRESSURE

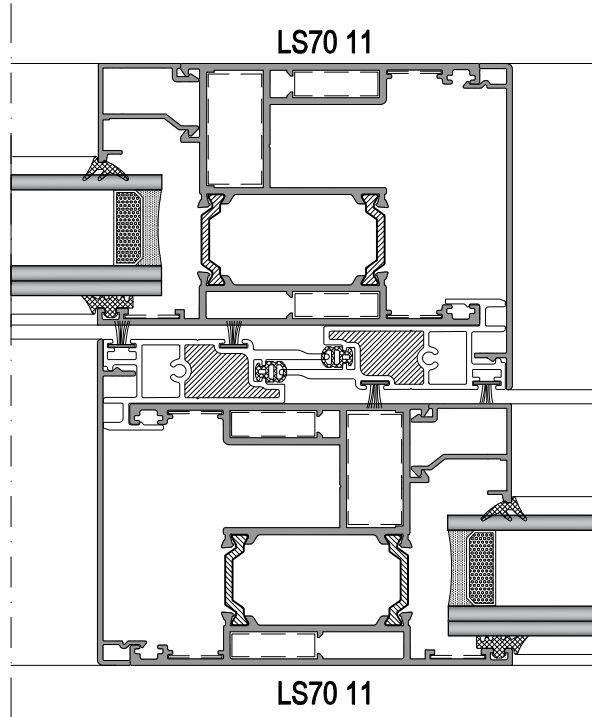
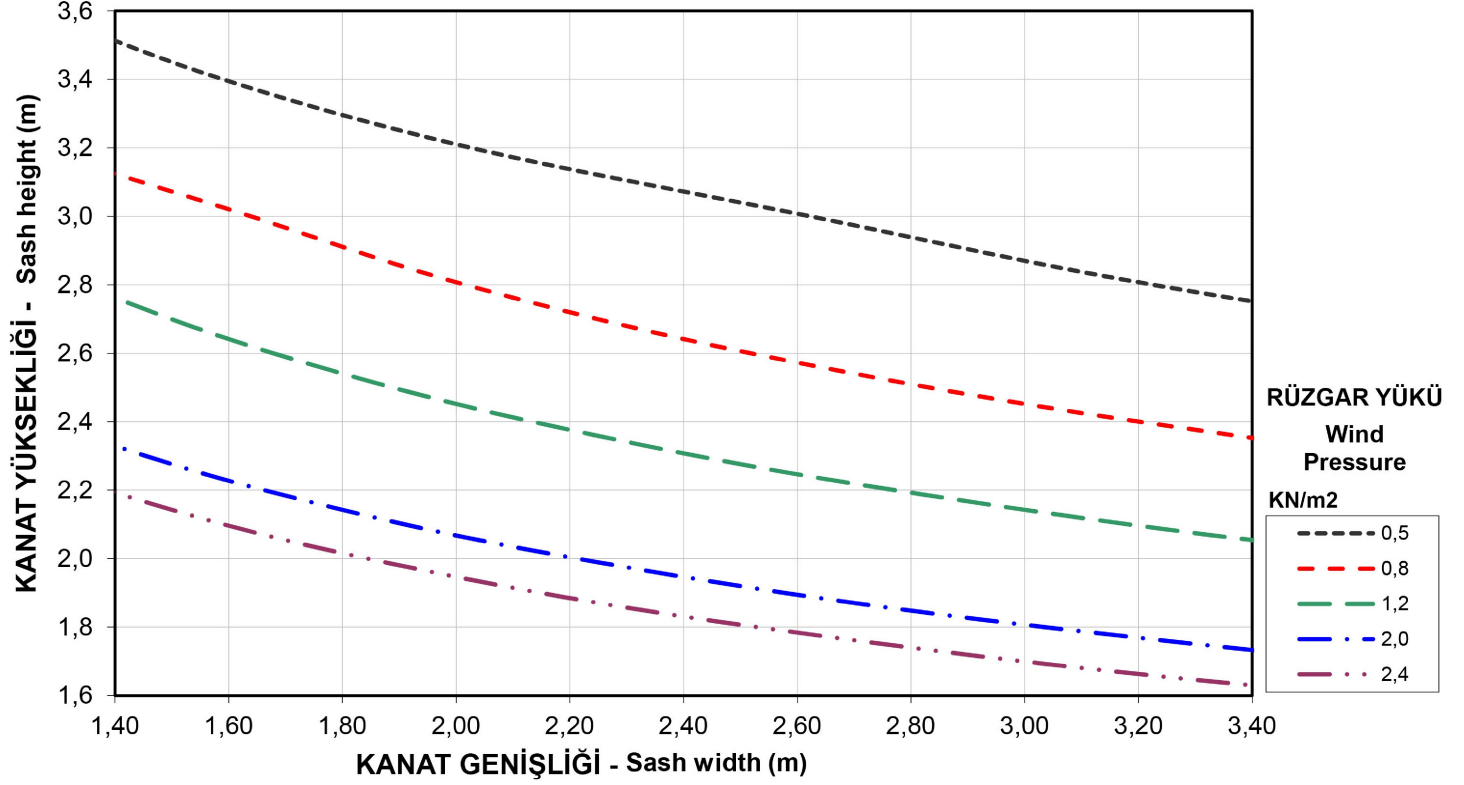

KANAT EBATLARI BELİRLENİRKEN MEKANİZMANIN TAŞIMA KAPASİTESİNİ GEÇMEMESİNE DİKKAT EDİLMELİDİR
WHILE THE SASH DIMENSIONS DETERMINED, SASH WEIGHT MUST BE LESS THAN ROLLER CARY CAPACITY

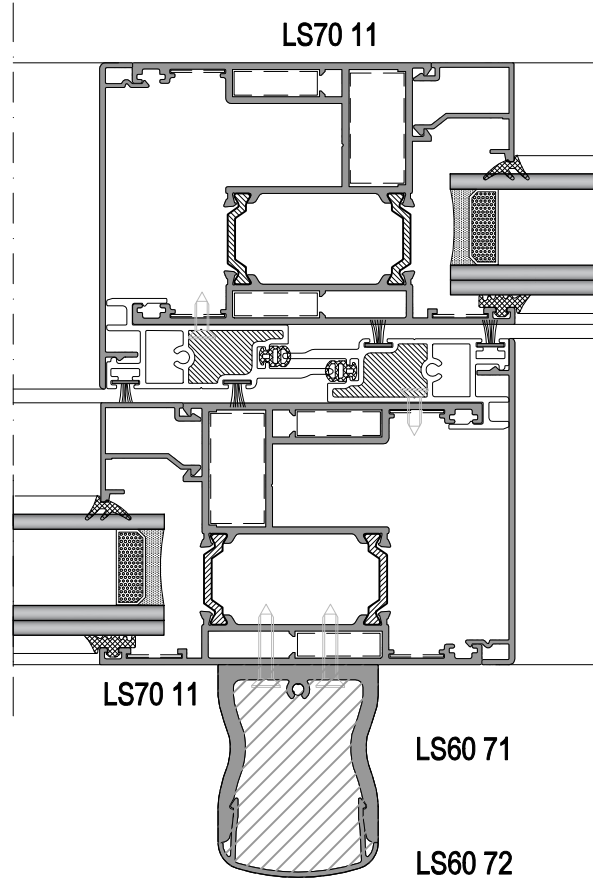
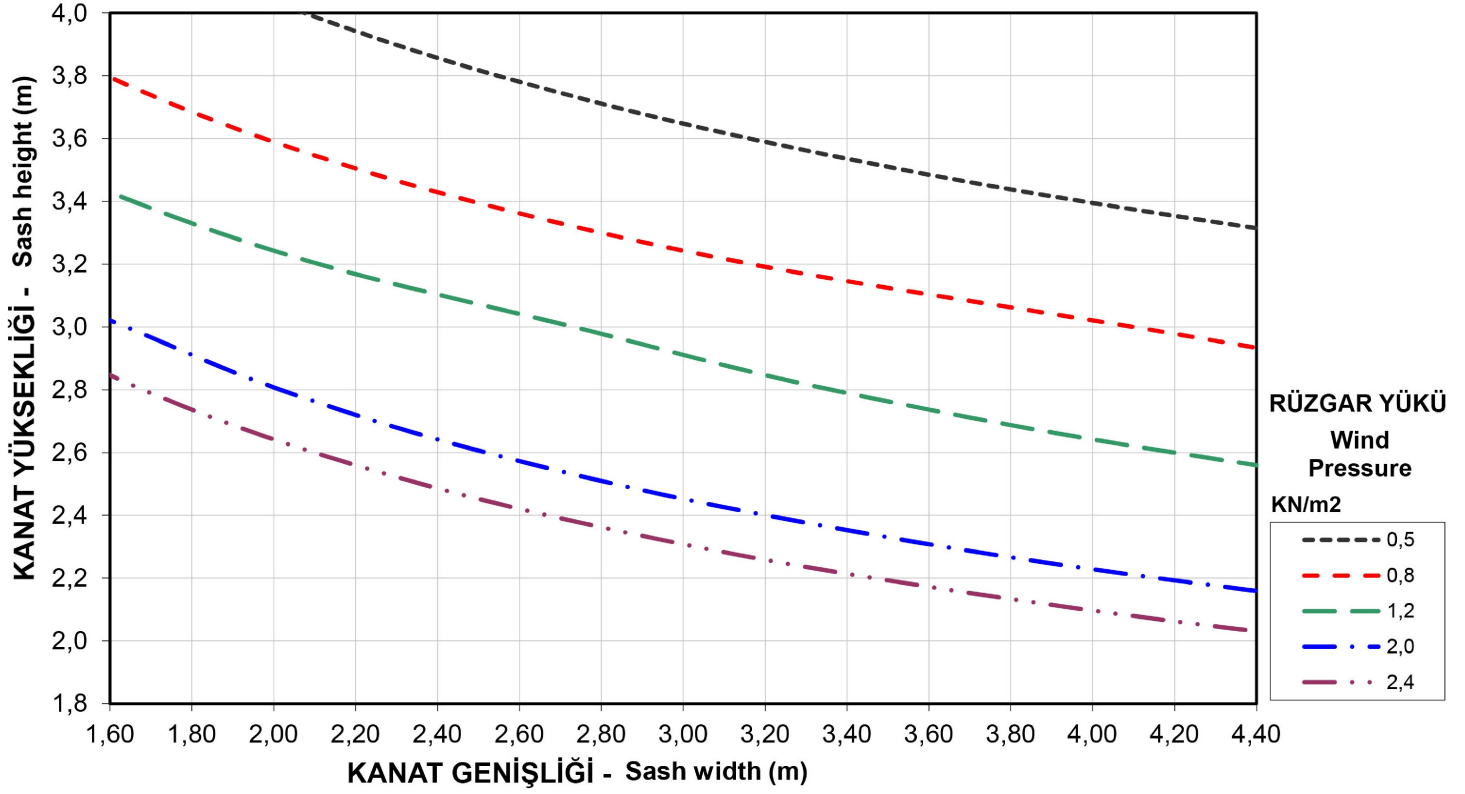
RÜZGAR YÜKÜNE GÖRE MAKSİMUM KANAT EBATLARI
MAXIMUM SASH DIMENSIONS FOR GIVEN WIND PRESSURE

KANAT EBATLARI BELİRLENİRKEN MEKANİZMANIN TAŞIMA KAPASİTESİNİ GEÇMEMESİNE DİKKAT EDİLMELİDİR
WHILE THE SASH DIMENSIONS DETERMINED, SASH WEIGHT MUST BE LESS THAN ROLLER CARY CAPACITY

LS70 - 1,8mm

YALITIMLI KALDIR-SÜR SİSTEMİ
THERMAL LIFT&SLIDE SYSTEM

ASISTAL

SİSTEM DETAYLARI
SYSTEM DETAILS

LS70 - 1,8mm

YALITIMLI KALDIR-SÜR SİSTEM
THERMAL LIFT&SLIDE SYSTEM

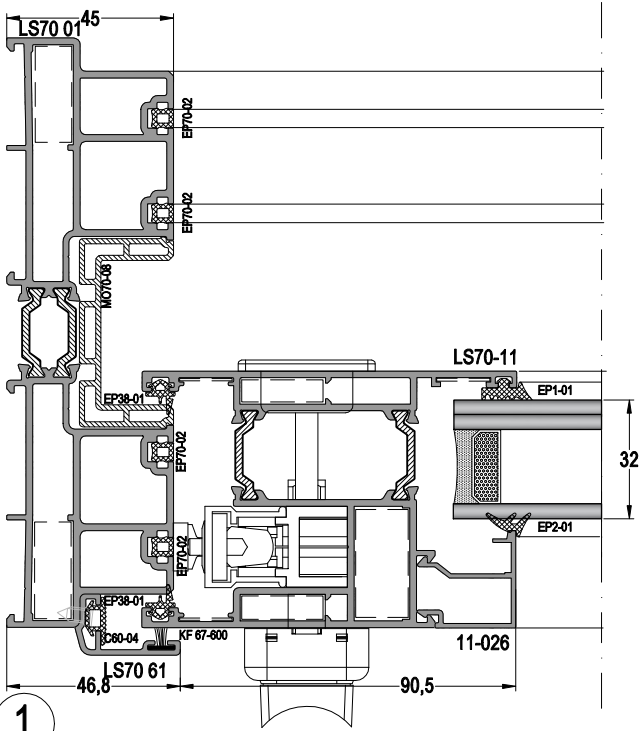

1

3

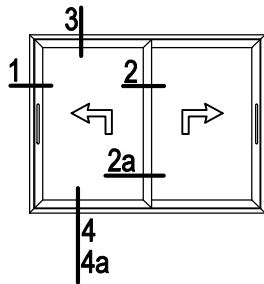
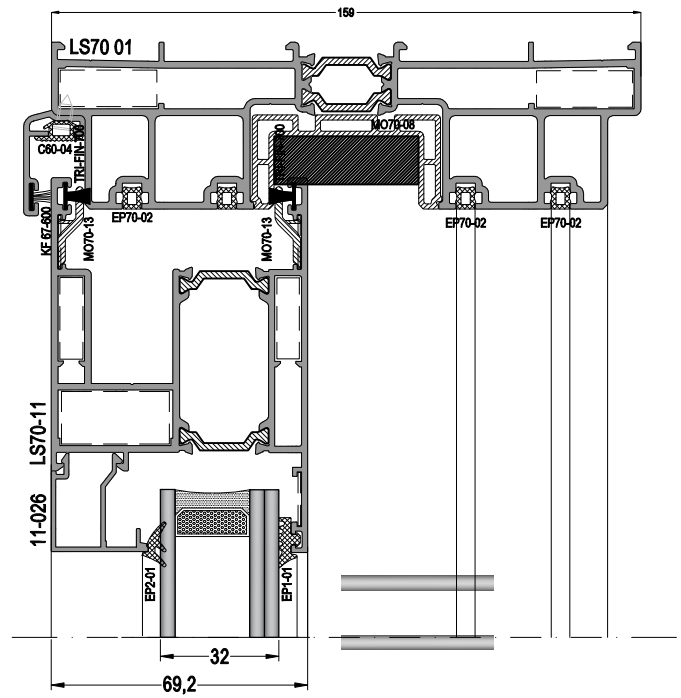

4

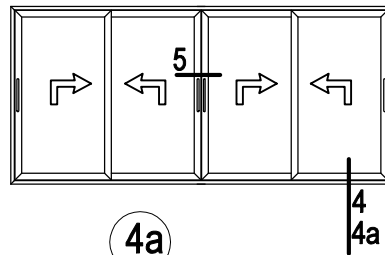

4a

Alternatif Ray Fıtlı
Alternative Gasket

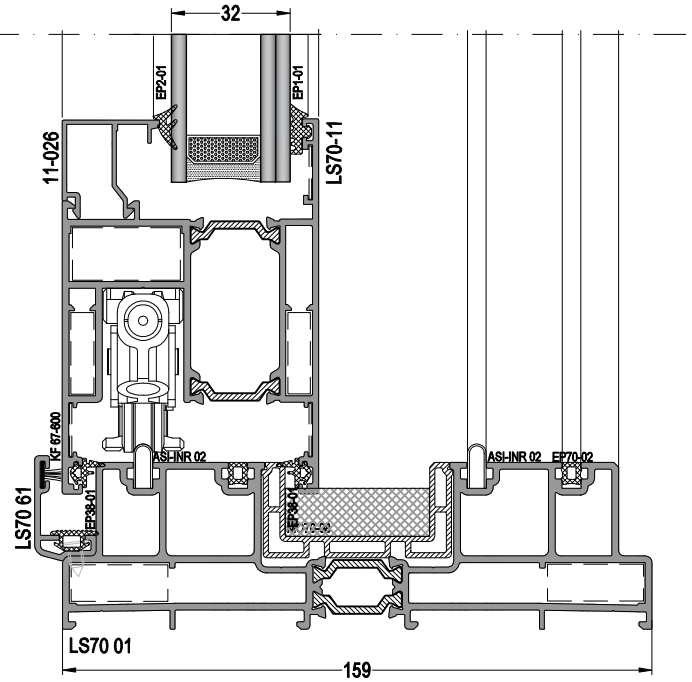
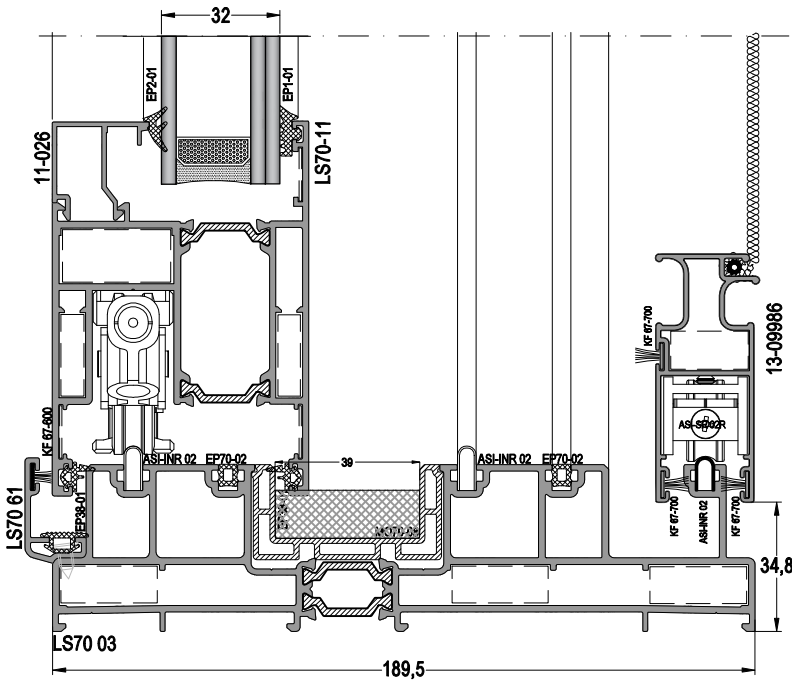
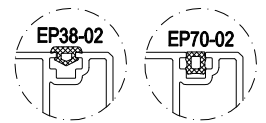

LS70 - 1,8mm

YALITIMLI KALDIR-SÜR SİSTEM
THERMAL LIFT&SLIDE SYSTEM

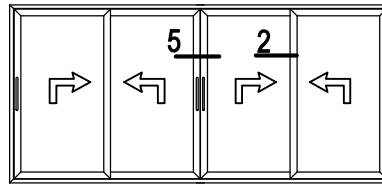
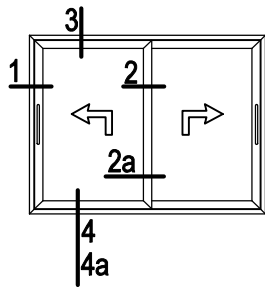

5

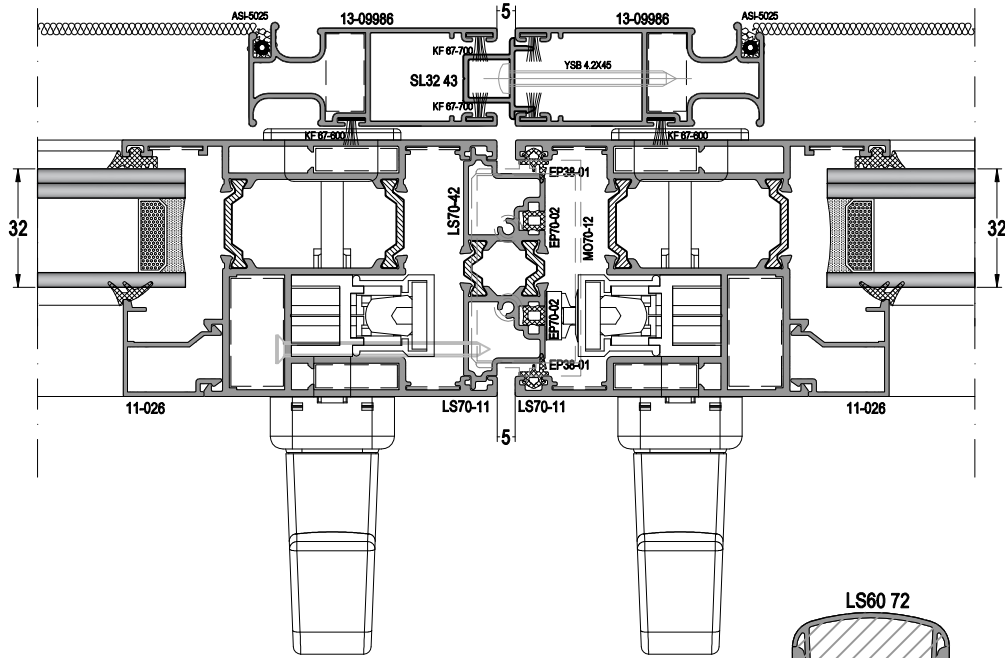

2

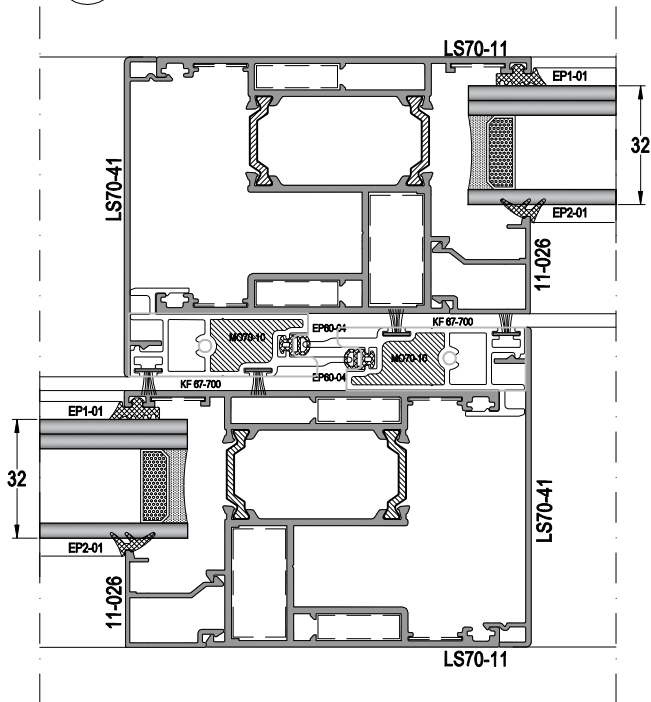

2A

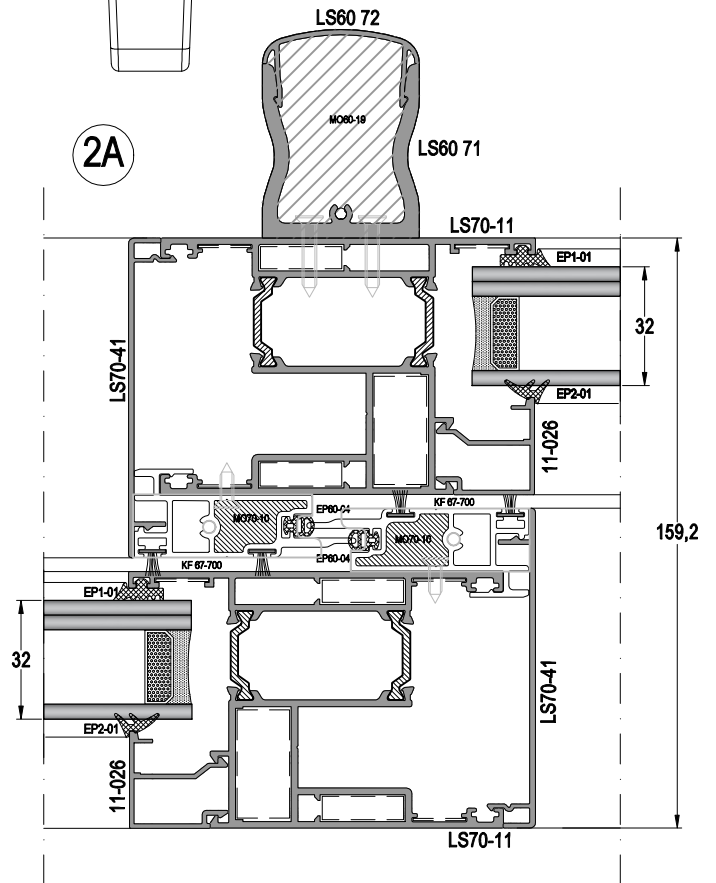

LS70 - 1,8mm

YALITIMLI KALDIR-SÜR SİSTEM
THERMAL LIFT&SLIDE SYSTEM

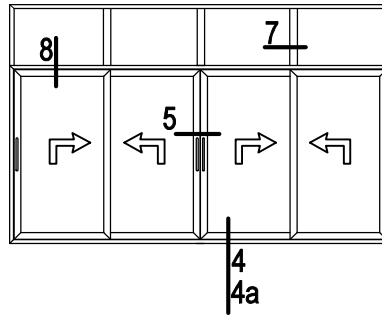
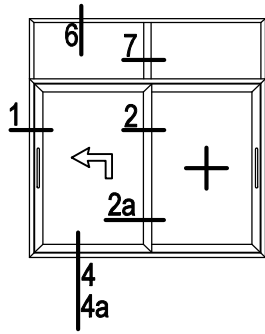

6

7

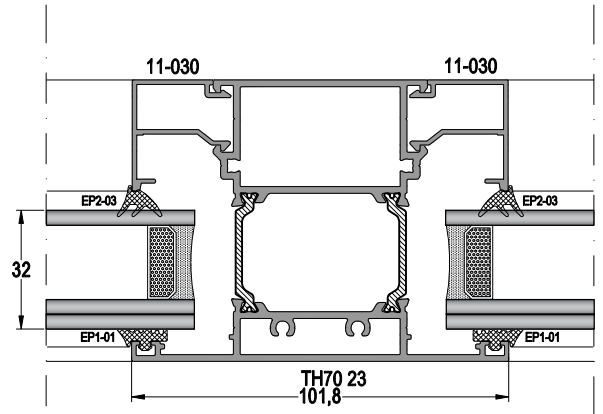
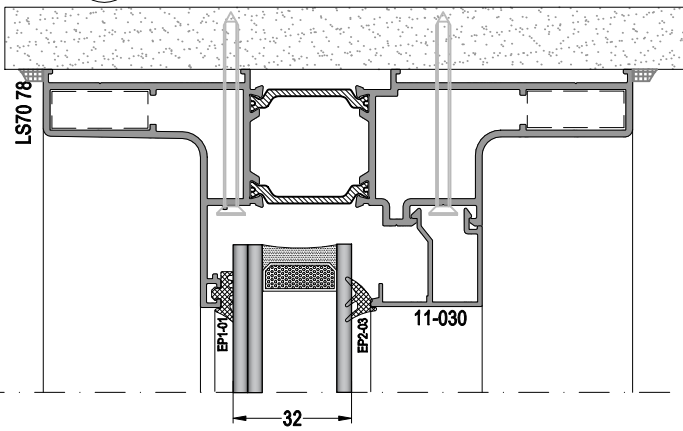

8

4B

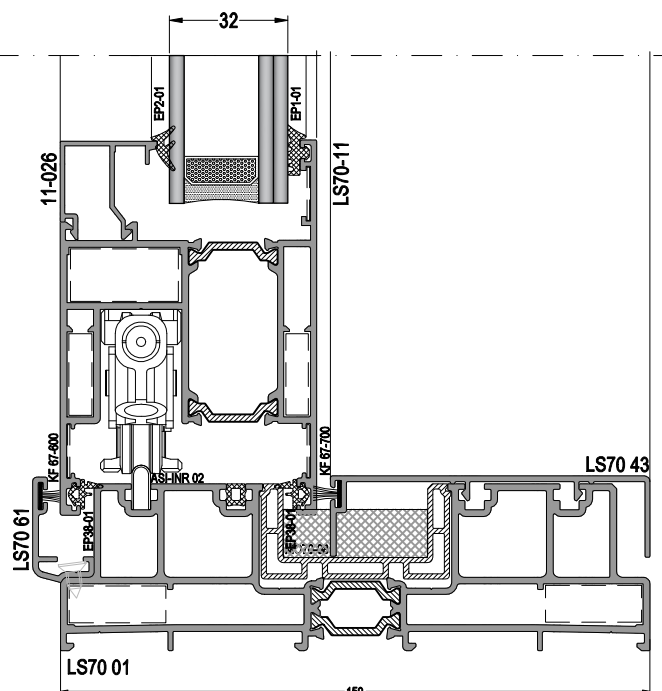
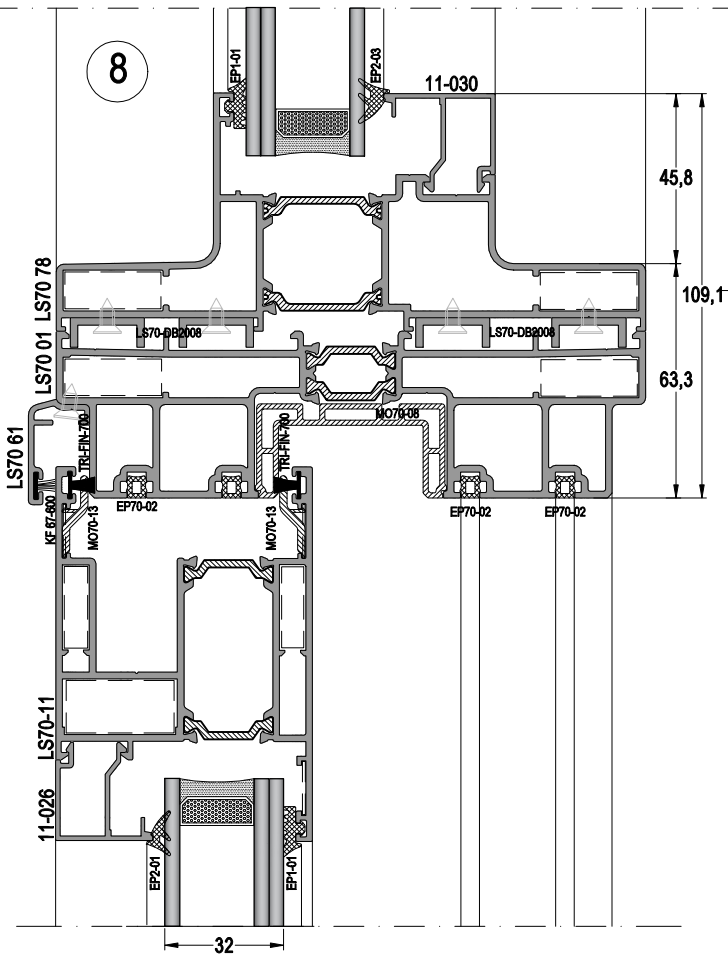

LS70 - 1,8mm

YALITIMLI KALDIR-SÜR SİSTEM
THERMAL LIFT&SLIDE SYSTEM

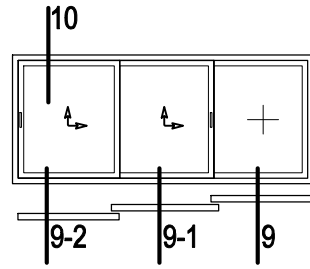
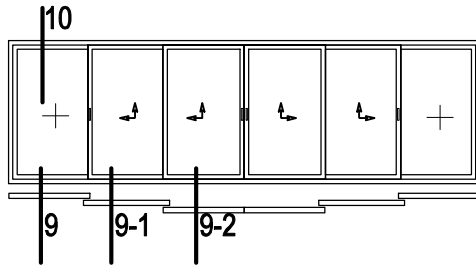

10

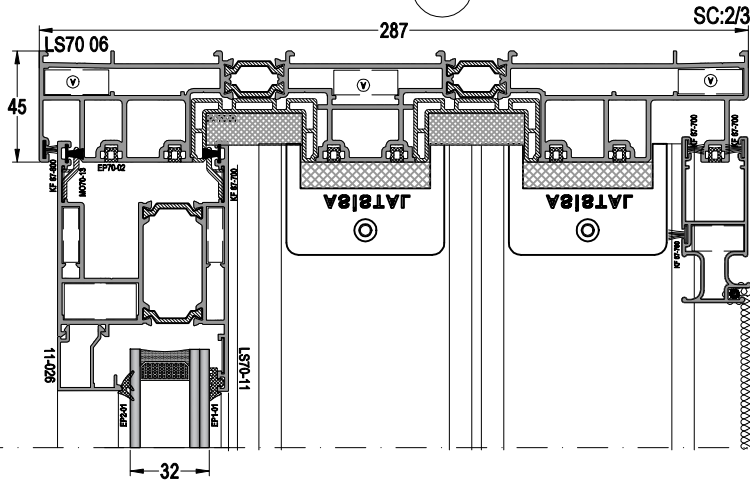

9-2

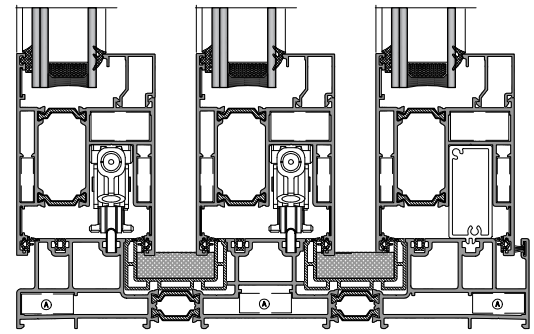

LS70 05

9

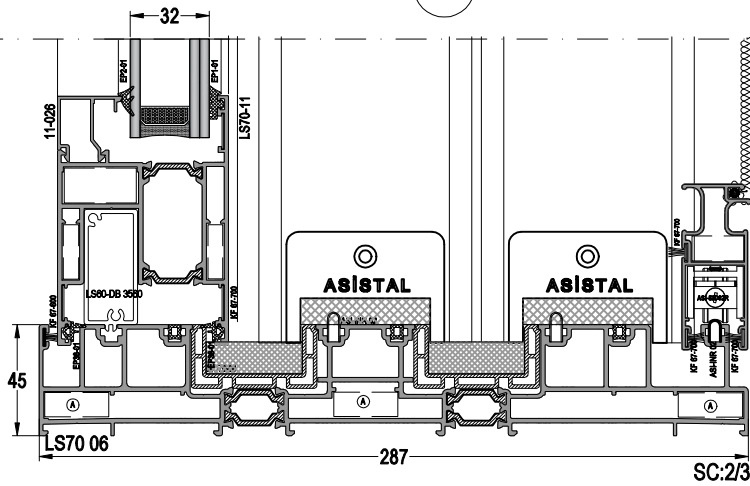

9-1

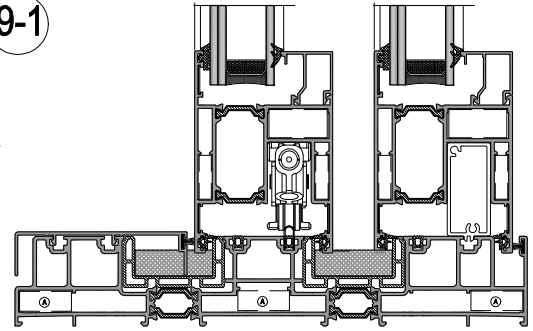

LS70 05

9

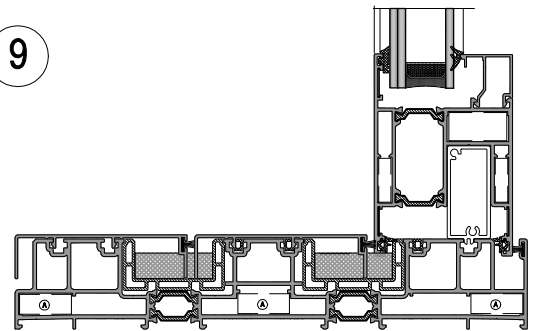

LS70 05

LS70 - 1,8mm

YALITIMLI KALDIR-SÜR SİSTEM
THERMAL LIFT&SLIDE SYSTEM

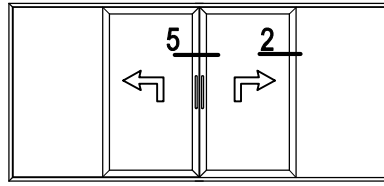
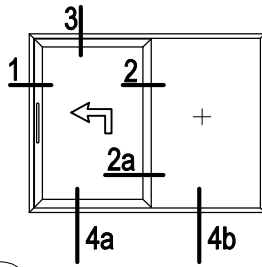

3

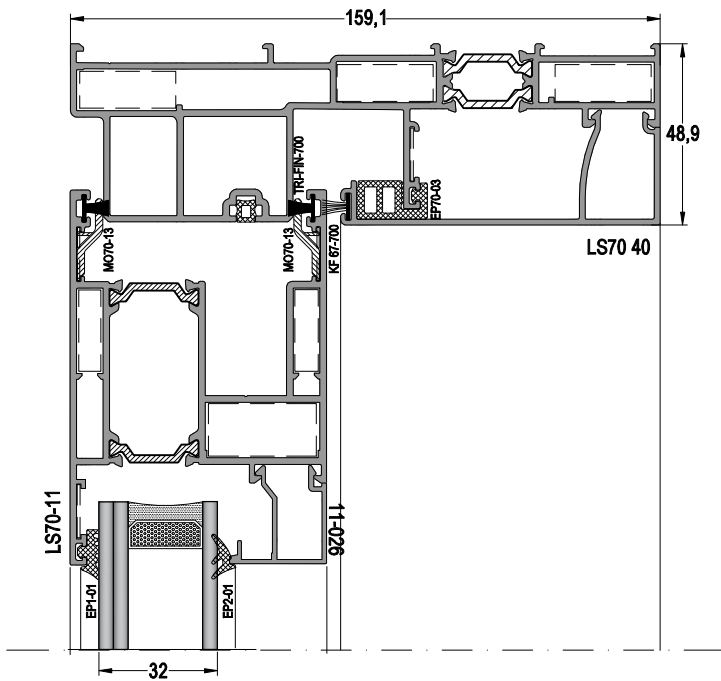

1

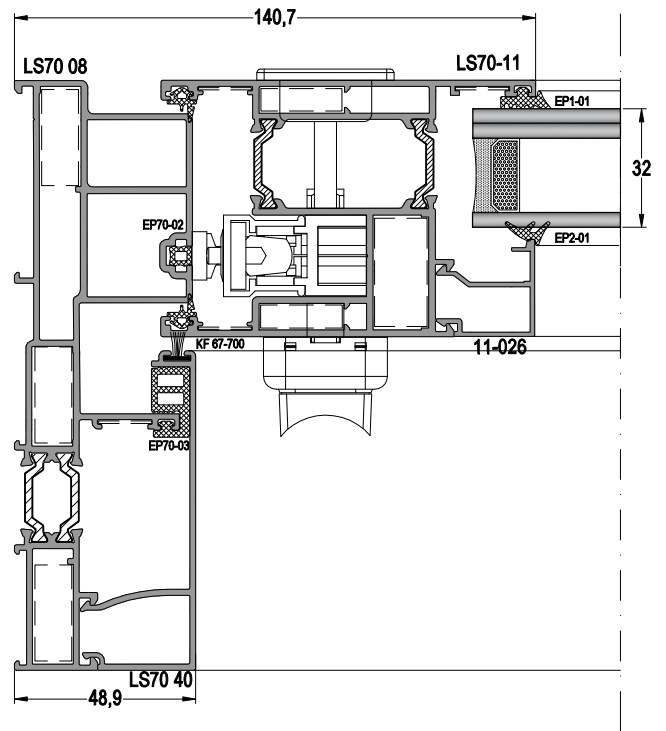

4

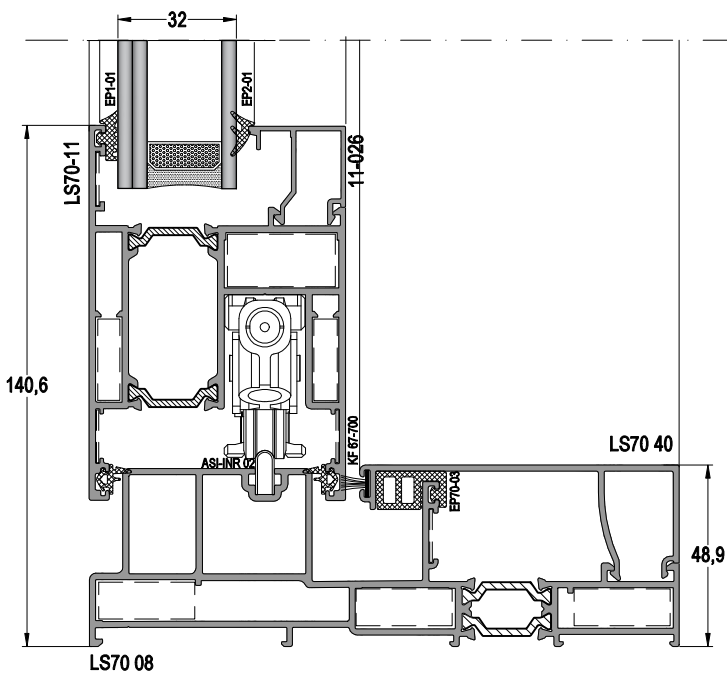

4a

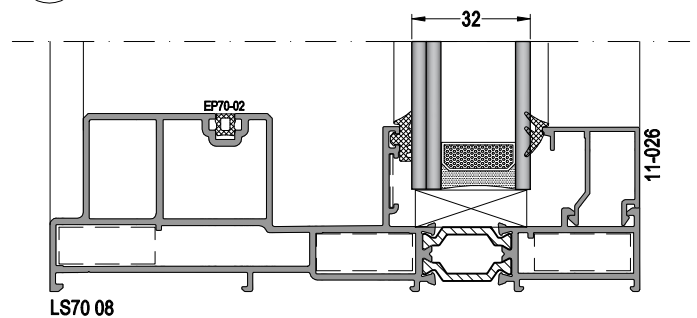

LS70 - 1,8mm

YALITIMLI KALDIR-SÜR SİSTEM
THERMAL LIFT&SLIDE SYSTEM

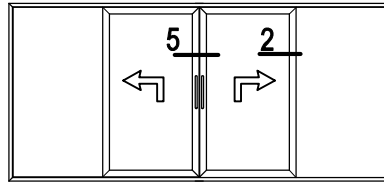
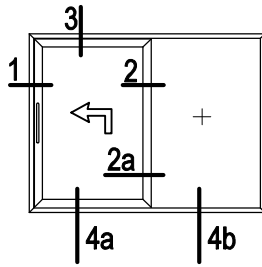

2

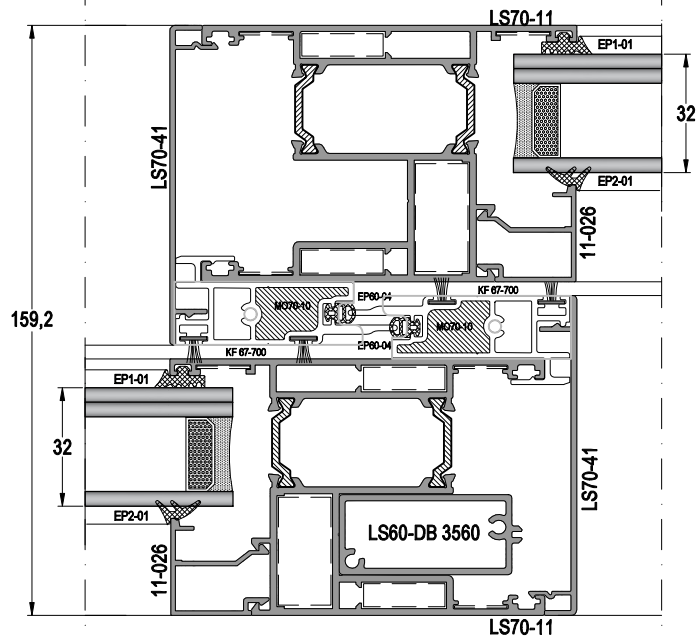

5

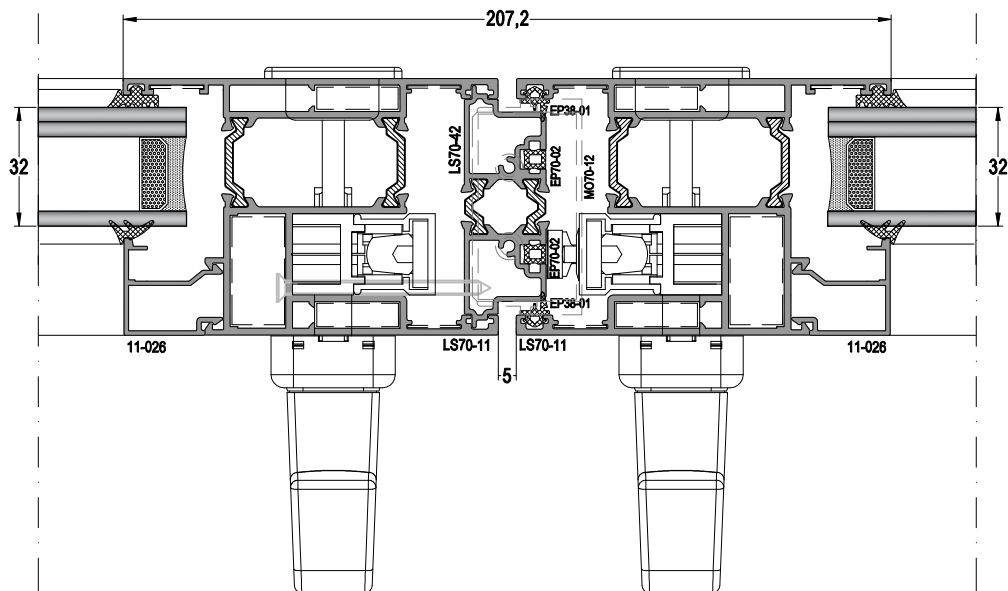

LS70 - 1,8mm

YALITIMLI KALDIR-SÜR SİSTEM
THERMAL LIFT&SLIDE SYSTEM

