

C55

YALITIMSIZ KAPI & PENCERE SİSTEMİ UNINSULATED WINDOW & DOOR SYSTEM

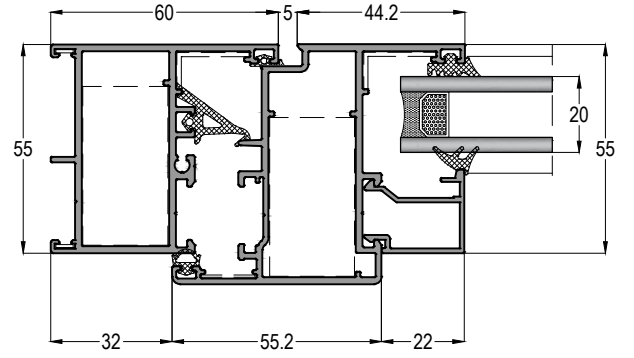
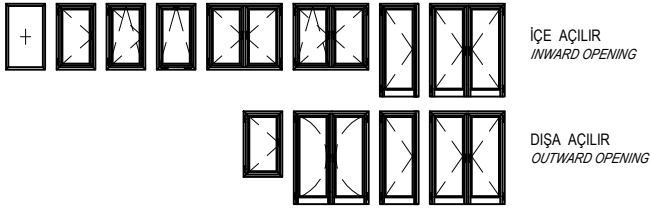

KASA GENİŞLİĞİ : 55 mm

Frame Width

KANAT DERİNLİĞİ : 63 mm

Sash Depth

SİSTEM ET KALINLIĞI : 1,4mm - 1,8mm - 2mm

System Wall Thickness

CAM KALINLIĞI : 4 - 40mm

Glass Thickness



C55

YALITIMSIZ KAPI-PENCERE SİSTEMİ
UNINSULATED WINDOW & DOOR SYSTEM

ASISTAL

PROFİL VE AKSESUAR LİSTELERİ
PROFILE & ACCESSORIES LISTS

PROFİL LİSTESİ - PROFILES LIST

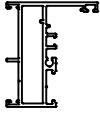
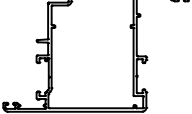
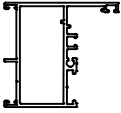
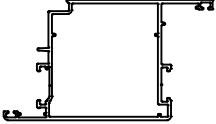
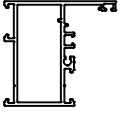
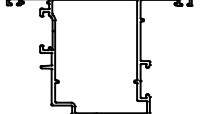
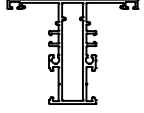
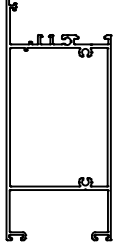
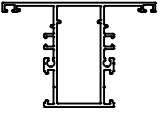
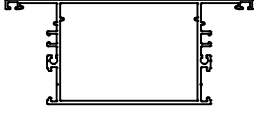
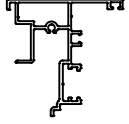
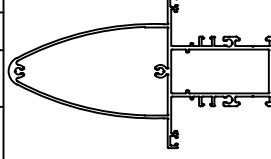
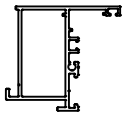
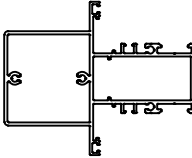
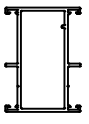
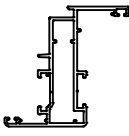
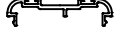
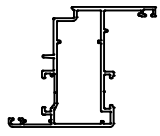
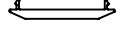
C55 01	Jx cm ⁴	Jy cm ⁴		C55 13	Jx cm ⁴	Jy cm ⁴		
	13,93	4,42			44,50	21,57		
KASA PROFİLİ-48 mm FRAME PROFILE	AĞIRLIK / Weight			İÇE AÇILIR KAPI KANAT PROFİLİ 64mm INWARD OPENING DOOR SASH PROFILE	AĞIRLIK / Weight			
	1,021 kg/mt				1,472 kg/mt			
C55 02	Jx cm ⁴	Jy cm ⁴		C55 15	Jx cm ⁴	Jy cm ⁴		
	17,03	9,74			59,11	29,03		
KASA PROFİLİ-60 mm FRAME PROFILE	AĞIRLIK / Weight			İÇE AÇILIR KAPI KANAT PROFİLİ 77 mm INWARD OPENING DOOR SASH PROFILE	AĞIRLIK / Weight			
	1,140 kg/mt				1,596 kg/mt			
C55 04	Jx cm ⁴	Jy cm ⁴		C55 14	Jx cm ⁴	Jy cm ⁴		
	18,01	8,53			31,11	33,14		
KASA PROFİLİ FRAME PROFILE	AĞIRLIK / Weight			DIŞA AÇILIR KAPI KANAT PROFİLİ OUTWARD OPENING DOOR SASH PROFILE	AĞIRLIK / Weight			
	1,134 kg/mt				1,469 kg/mt			
C55 21	Jx cm ⁴	Jy cm ⁴		C55 31	Jx cm ⁴	Jy cm ⁴		
	16,26	8,28			104,06	36,64		
ORTA KAYIT PROFİLİ 69 mm TRANSOM-MULLION PROFILE	AĞIRLIK / Weight			ETEK PROFİLİ-130 mm BOTTOM PLATE PROFILE	AĞIRLIK / Weight			
	1,220 kg/mt				1,941 kg/mt			
C55 22	Jx cm ⁴	Jy cm ⁴						
	19,44	15,87						
ORTA KAYIT PROFİLİ 80 mm TRANSOM-MULLION PROFILE	AĞIRLIK / Weight							
	1,337 kg/mt							
C55 23	Jx cm ⁴	Jy cm ⁴		C55 41	ÇİFT KANAT ADAPTÖR PROFİLİ DOUBLE SASH ADAPTER PROFILE	AĞIRLIK / Weight		
	32,36	88,07				1,037 kg/mt		
ORTA KAYIT PROFİLİ 130 mm TRANSOM-MULLION PROFILE	AĞIRLIK / Weight							
	1,817 kg/mt							
C55 24	Jx cm ⁴	Jy cm ⁴		C55 43	DIŞA AÇILIR KAPI ADAPTÖR PROFİLİ OUTWARD OPENING DOOR ADAPTER PROFILE	AĞIRLIK / Weight		
	132,88	25,86				1,080 kg/mt		
TAKVİYELİ ORTA KAYIT PROFİLİ SUPPORTED MULLION PROFILE	AĞIRLIK / Weight							
	2,255 kg/mt							
C55 25	Jx cm ⁴	Jy cm ⁴		C55 44	ÇARPMA KAPI KASA PROFİLİ SWING DOOR FRAME PROFILE	AĞIRLIK / Weight		
	70,54	25,44				0,942 kg/mt		
TAKVİYELİ ORTA KAYIT PROFİLİ SUPPORTED MULLION PROFILE	AĞIRLIK / Weight							
	2,055 kg/mt							
C55 11	Jx cm ⁴	Jy cm ⁴		C55 45	ÇARPMA KAPI ADAPTÖR PROFİLİ ADAPTER PROFILE	AĞIRLIK / Weight		
	21,45	7,07				0,446 kg/mt		
KANAT PROFİLİ-30 mm SASH PROFILE	AĞIRLIK / Weight							
	1,145 kg/mt							
C55 12	Jx cm ⁴	Jy cm ⁴		C55 46	ÇARPMA KAPI ADAPTÖR PROFİLİ ADAPTER PROFILE	AĞIRLIK / Weight		
	26,02	9,94				0,689 kg/mt		
KANAT PROFİLİ-44 mm SASH PROFILE	AĞIRLIK / Weight							
	1,277 kg/mt							

Profil ağırlıklarımız teorik olup; teslim anındaki tartımız geçerlidir.







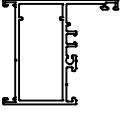
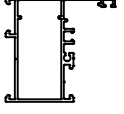
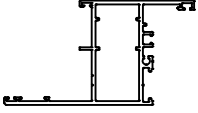
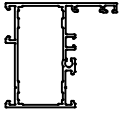
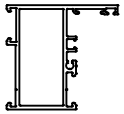
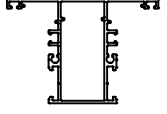
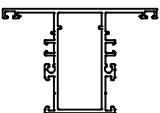
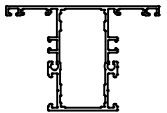
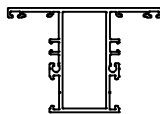
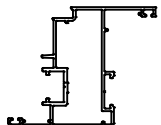
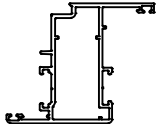
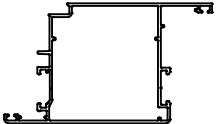
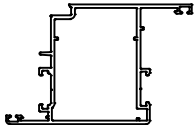
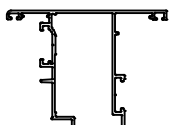
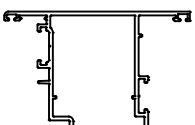
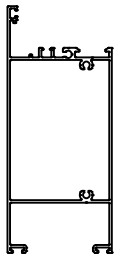
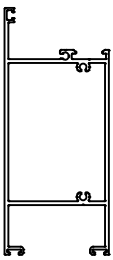













Profile weights are theoretical and the weight at the time of delivery is valid.

PROFİL LİSTESİ / 2 mm - PROFILES LIST / 2mm







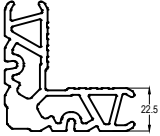
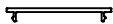
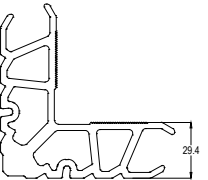

PROFİL LİSTESİ / 1.4 mm - PROFILES LIST / 1.4mm

C55 202	Jx cm ⁴	Jy cm ⁴		C55 104	Jx cm ⁴	Jy cm ⁴	
	21,38	9,19			15,05	7,28	
2mm KASA PROFİLİ 2mm FRAME PROFILE	AĞIRLIK / Weight			1.4mm KASA PROFİLİ 1.4mm FRAME PROFILE	AĞIRLIK / Weight		
	1,217 kg/mt				0,965 kg/mt		
C55 203		AĞIRLIK / Weight	C55 105	Jx cm ⁴	Jy cm ⁴		
				1,505 kg/mt	16,50		7,90
2mm KASA PROFİLİ 2mm FRAME PROFILE	AĞIRLIK / Weight		1.4mm KASA PROFİLİ 1.4mm FRAME PROFILE	AĞIRLIK / Weight			
1,505 kg/mt		1,017 kg/mt					
C55 204	Jx cm ⁴	Jy cm ⁴		C55 122	Jx cm ⁴	Jy cm ⁴	
	19,69	8,95			16,28	13,84	
2mm KASA PROFİLİ 2mm FRAME PROFILE	AĞIRLIK / Weight			1.4mm ORTA KAYIT PROFİLİ - 81 mm TRANSOM-MULLION PROFILE	AĞIRLIK / Weight		
	1,217 kg/mt				1,140 kg/mt		
C55 222	Jx cm ⁴	Jy cm ⁴		C55 123	Jx cm ⁴	Jy cm ⁴	
	21,01	16,97			17,83	15,09	
2mm ORTA KAYIT PROFİLİ - 81 mm TRANSOM-MULLION PROFILE	AĞIRLIK / Weight			1.4mm ORTA KAYIT PROFİLİ - 81 mm TRANSOM-MULLION PROFILE	AĞIRLIK / Weight		
	1,442 kg/mt				1,215 kg/mt		
C55 223	Jx cm ⁴	Jy cm ⁴		C55 114	Jx cm ⁴	Jy cm ⁴	
	20,95	17,41			27,28	8,63	
2mm ORTA KAYIT PROFİLİ - 81 mm TRANSOM-MULLION PROFILE	AĞIRLIK / Weight			1.4 mm KANAT PROFİLİ MULTI POINT SİSTEM SASH PROFILE-MULTI POINT	AĞIRLIK / Weight		
	1,437 kg/mt				1,182 kg/mt		
C55 212	Jx cm ⁴	Jy cm ⁴		C55 115	Jx cm ⁴	Jy cm ⁴	
	34,00	10,59			51,94	23,91	
2mm KANAT PROFİLİ 2mm SASH PROFILE	AĞIRLIK / Weight			1.4mm İÇE AÇILIR KAPI KANAT PROFİLİ 1.4mm INNER OPENING DOOR SASH PROFILE	AĞIRLIK / Weight		
	1,439 kg/mt				1,355 kg/mt		
C55 213	Jx cm ⁴	Jy cm ⁴		C55 117	Jx cm ⁴	Jy cm ⁴	
	49,91	24,03			23,13	17,38	
2mm İÇE AÇILIR KAPI KANAT PROFİLİ 2mm INWARD OPENING DOOR SASH PROFILE	AĞIRLIK / Weight			1.4mm DİŞA AÇILIR PENCERE KANAT PRO. OUTWARD OPENING WINDOW SASH PROFILE	AĞIRLIK / Weight		
	1,658 kg/mt				1,169 kg/mt		
C55 214	Jx cm ⁴	Jy cm ⁴		C55 131	Jx cm ⁴	Jy cm ⁴	
	38,68	33,88			109,58	39,47	
2mm DİŞA AÇILIR KAPI KANAT PROFİLİ 2mm OUTWARD OPENING DOOR SASH PROFILE	AĞIRLIK / Weight			1.4mm ETEK PROFİLİ 1.4mm BOTTOM PLATE PROFILE	AĞIRLIK / Weight		
	1,672 kg/mt				1,631 kg/mt		
C55 231	Jx cm ⁴	Jy cm ⁴					
	109,58	39,47					
2mm ETEK PROFİLİ 2mm BOTTOM PLATE PROFILE	AĞIRLIK / Weight						
	2,076 kg/mt						

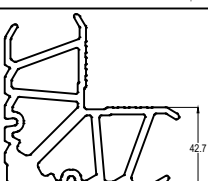
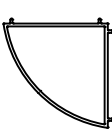
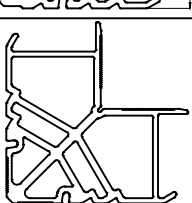
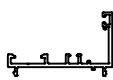
PROFİL LİSTESİ - PROFILES LIST

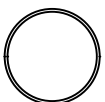
11-004			11-032		
CAM ÇİTASI-4 mm GLAZING BEAD PROFILE	AĞIRLIK / Weight 0,181 kg/mt		CAM ÇİTASI-32 mm GLAZING BEAD PROFILE	AĞIRLIK / Weight 0,315 kg/mt	
11-006			11-035		
CAM ÇİTASI-6 mm GLAZING BEAD PROFILE	AĞIRLIK / Weight 0,218 kg/mt		CAM ÇİTASI-35 mm GLAZING BEAD PROFILE	AĞIRLIK / Weight 0,323 kg/mt	
11-010			11-038		
CAM ÇİTASI-10 mm GLAZING BEAD PROFILE	AĞIRLIK / Weight 0,233 kg/mt		CAM ÇİTASI-38 mm GLAZING BEAD PROFILE	AĞIRLIK / Weight 0,334 kg/mt	
11-015			12-01		
CAM ÇİTASI-15 mm GLAZING BEAD PROFILE	AĞIRLIK / Weight 0,244 kg/mt		DAMLALIK PROFİLİ RAINDROP PROFILE	AĞIRLIK / Weight 0,198 kg/mt	
11-017			12-02		
CAM ÇİTASI-17 mm GLAZING BEAD PROFILE	AĞIRLIK / Weight 0,250 kg/mt		DAMLALIK PROFİLİ RAINDROP PROFILE	AĞIRLIK / Weight 0,136 kg/mt	
11-020			12-03		
CAM ÇİTASI-20 mm GLAZING BEAD PROFILE	AĞIRLIK / Weight 0,276 kg/mt		DAMLALIK PROFİLİ RAINDROP PROFILE	AĞIRLIK / Weight 0,313 kg/mt	
11-022			12-52		
CAM ÇİTASI-22 mm GLAZING BEAD PROFILE	AĞIRLIK / Weight 0,282 kg/mt		PERVAZ PROFİLİ BORDER PROFILE	AĞIRLIK / Weight 0,279 kg/mt	
11-026			12-53		
CAM ÇİTASI-26 mm GLAZING BEAD PROFILE	AĞIRLIK / Weight 0,296 kg/mt		PERVAZ MONTAJ PROFİLİ BORDER FIXING PROFILE	AĞIRLIK / Weight 0,177 kg/mt	
11-028			12-54		
CAM ÇİTASI-28 mm GLAZING BEAD PROFILE	AĞIRLIK / Weight 0,302 kg/mt		PERVAZ PROFİLİ BORDER PROFILE	AĞIRLIK / Weight 0,326 kg/mt	
11-030			12-57		
CAM ÇİTASI-30 mm GLAZING BEAD PROFILE	AĞIRLIK / Weight 0,308 kg/mt		PERVAZ PROFİLİ BORDER PROFILE	AĞIRLIK / Weight 0,358 kg/mt	

PROFİL LİSTESİ - PROFILES LIST

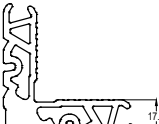
C55 47			10-010225-00		
ADAPTÖR PROFİLİ ADAPTER PROFILE	AĞIRLIK / Weight 0,184 kg/mt		KÖŞE TAKOZU-22,5 mm CORNER JOINT	AĞIRLIK / Weight 3,566 kg/mt	
C55 48			10-010294-00		
ADAPTÖR PROFİLİ ADAPTER PROFILE	AĞIRLIK / Weight 0,335 kg/mt		KÖŞE TAKOZU-29,4 mm CORNER JOINT	AĞIRLIK / Weight 4,806 kg/mt	
C55 49			10-010429-00		
ADAPTÖR PROFİLİ ADAPTER PROFILE	AĞIRLIK / Weight 0,179 kg/mt		KÖŞE TAKOZU-42,7 mm CORNER JOINT	AĞIRLIK / Weight 5,483 kg/mt	
C55 51	Jx cm ⁴ 10,80		10-010553-00		
	Jy cm ⁴ 14,75		KÖŞE TAKOZU-55,3 mm CORNER JOINT	AĞIRLIK / Weight 6,251 kg/mt	
90° KÖŞE PROFİLİ CORNER PROFILE	AĞIRLIK / Weight 0,845 kg/mt				
C55 55			12-91		
ÇARPMA KAPI ADAPTÖR PROFİLİ ADAPTER PROFILE	AĞIRLIK / Weight 0,570 kg/mt		DİK BAĞLANTI T JOINT	AĞIRLIK / Weight 0,794 kg/mt	
01-000500-15					
EKSENEL DÖNÜŞ PROFİLİ CORNER PROFILE	AĞIRLIK / Weight 0,619 kg/mt				
12-41					
TİJ PROFİLİ SASH PROFILE	AĞIRLIK / Weight 0,118 kg/mt				
04-025025-12					
KASA T 'Sİ - 30 mm FRAME BORDER	AĞIRLIK / Weight 0,159 kg/mt				
10-010106-00					
KÖŞE TAKOZU-10,6 mm CORNER JOINT	AĞIRLIK / Weight 2,653 kg/mt				
10-010175-00					
KÖŞE TAKOZU-17,5 mm CORNER JOINT	AĞIRLIK / Weight 3,336 kg/mt				

Profil ağırlıklarımız teorik olup; teslim anındaki tartımız geçerlidir.











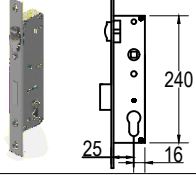
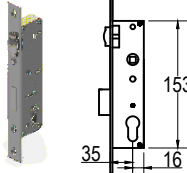
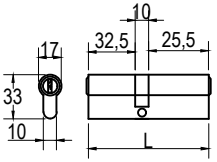

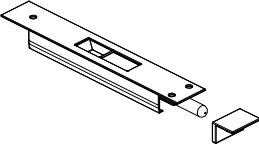
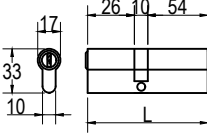
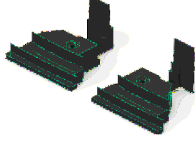
Profile weights are theoretical and the weight at the time of delivery is valid.

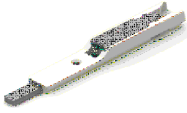
EP1-01			ASI-F 100A		
DIŞ CAM FİTİLİ - 3,5 mm <i>OUTER GLAZING GASKET</i>	KOLİ MİKTARI/Package 240 mt / 15 kg		KAPI ALTI FIRÇASI <i>DOOR BRUSH GASKET</i>	KOLİ MİKTARI/Package Adet / Piece	
KC 02			ASI-H 3300		
CAM FİTİLİ - 2 mm <i>GLAZING GASKET</i>	KOLİ MİKTARI/Package 100 mt / 4,5 kg		SİSTEM KAPI MENTEŞESİ <i>SYSTEM DOOR HINGE</i>	KOLİ MİKTARI/Package Adet / Piece	
EP2-01			ASI-H 9730		
İÇ CAM FİTİLİ - 3 mm <i>INNER GLAZING GASKET</i>	KOLİ MİKTARI/Package 440 mt / 15 kg		SİSTEM İKİLİ MENTEŞE <i>DOUBLE SYSTEM HINGE</i>	KOLİ MİKTARI/Package 250 Adet / Piece	
EP2-02			ASI-H 9733		
İÇ CAM FİTİLİ - 4 mm <i>INNER GLAZING GASKET</i>	KOLİ MİKTARI/Package 300 mt / 15 kg		SİSTEM ÜÇLÜ MENTEŞE <i>TRIPLE SYSTEM HINGE</i>	KOLİ MİKTARI/Package 250 Adet / Piece	
EP3-02			ASI-V 816		
KASA BİNİ FİTİLİ <i>FRAME GASKET</i>	KOLİ MİKTARI/Package 750 mt / 15 kg		VASİSTAS AÇILIM KOLU <i>TRANSOM OPENING HANDLE</i>	KOLİ MİKTARI/Package 50 Adet / Piece	
EP3-03			ASI-V 820		
KANAT BİNİ FİTİLİ <i>SASH GASKET</i>	KOLİ MİKTARI/Package 430 mt / 15 kg		VASİSTAS AÇILIM KOLU <i>TRANSOM OPENING HANDLE</i>	KOLİ MİKTARI/Package 30 Adet / Piece	
EP4-06			ASI-V 1000		
ORTA BİNİ FİTİLİ <i>GASKET FOR OPEN JOINT</i>	KOLİ MİKTARI/Package 130 mt / 15 kg		VASİSTAS MAKAS (PVC) <i>TRANSOM RESTRICTOR</i>	KOLİ MİKTARI/Package 120 Adet / Piece	
EP4-06K			ASI-V 1080		
VULKANİZE FİTİL <i>GASKET FOR CORNER</i>	KOLİ MİKTARI/Package Adet / Piece		VASİSTAS MAKAS <i>TRANSOM RESTRICTOR</i>	KOLİ MİKTARI/Package 60 Adet / Piece	
KF 67-600			ASI-V 1275-3		
FIRÇA FİTİL - 6mm <i>BRUSH GASKET</i>	KOLİ MİKTARI/Package 1300 mt		VASİSTAS 3 KADEMELİ ÇELİK MAKAS <i>TRANSOM RESTRICTOR WITH 3 POSITIONS</i>	KOLİ MİKTARI/Package 2'li Takım/ Set	
KF 67-1000			ASI-V 1275-5		
FIRÇA FİTİL - 10mm <i>BRUSH GASKET</i>	KOLİ MİKTARI/Package 600 mt		VASİSTAS 5 KADEMELİ ÇELİK MAKAS <i>TRANSOM RESTRICTOR WITH 5 POSITIONS</i>	KOLİ MİKTARI/Package 2'li Takım/ Set	

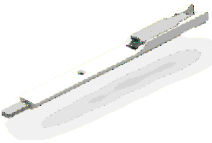
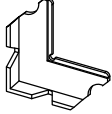

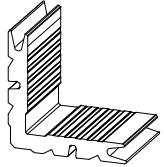
AKSESUAR LİSTESİ - ACCESSORIES LIST

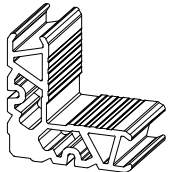
ASI-WH 003			ASI-WH 005		
TEK DİLLİ EKSENEL KOL <i>WINDOW HANDLE</i>	KOLİ MİKTARI/Package Adet / Piece		DIŞA AÇILIR PENCERE KANAT KOLU <i>WINDOW HANDLE FOR OUTWARD OPENING</i>	KOLİ MİKTARI/Package Adet / Piece	
ASI-WH 004			ASI-WH005-58		
ÇİFT DİLLİ EKSENEL KOL <i>WINDOW HANDLE</i>	KOLİ MİKTARI/Package Adet / Piece		DIŞA AÇILIR PENCERE KOL DİLİ - 58mm <i>HANDLE FORK FOR OUTWARD OPENING - 58mm</i>	KOLİ MİKTARI/Package Adet / Piece	
ASI-WH 004A			ASI-WH 005K		
ÇİFT DİLLİ EKSENEL KOL - ANAHTARLI <i>WINDOW HANDLE WITH LOCK</i>	KOLİ MİKTARI/Package Adet / Piece		DIŞA AÇILIR PENCERE KOL BAĞLANTI-19mm <i>HANDLE CONNECTOR FOR OUTWARD OPENING-19mm</i>	KOLİ MİKTARI/Package Adet / Piece	
ASI-KA M108			ASI-RP 001		
EKSENEL KOL KİLİTLEME MEKANİZMASI <i>LOCKING FOR WINDOW</i>	KOLİ MİKTARI/Package Adet / Piece		TİJ PİMİ <i>ROD PROFILE LOCKING</i>	KOLİ MİKTARI/Package Adet / Piece	
ASI-KA P200			ASI-RS 001		
EKSENEL KOL KİLİTLEME MEKANİZMASI <i>LOCKING FOR WINDOW</i>	KOLİ MİKTARI/Package Adet / Piece		PİM KARŞILIĞI <i>ROD PROFILE STRIKES</i>	KOLİ MİKTARI/Package 120 Adet / Piece	
ASI-KA VNT			ASI-WH 007		
KANAT SABİTLEME <i>SASH FIXING</i>	KOLİ MİKTARI/Package Adet / Piece		DIŞA AÇILIR KARE MİLLİ PENCERE KOLU <i>BAS WINDOW HANDLE FOR OUTWARD OPENING</i>	KOLİ MİKTARI/Package Adet / Piece	
ASI-WH 001			ASI-RP 002		
KARE MİLLİ PENCERE KOLU <i>WINDOW HANDLE</i>	KOLİ MİKTARI/Package Adet / Piece		DIŞA AÇILIM TİJ PİMİ <i>ROD PROFILE LOCKING FOR OUTWARD OPENING</i>	KOLİ MİKTARI/Package Adet / Piece	
ASI-WH 001A			ASI-RS 003		
KARE MİLLİ PENCERE KOLU-ANAHTARLI <i>WINDOW HANDLE WITH LOCK</i>	KOLİ MİKTARI/Package Adet / Piece		DIŞA AÇILIM PİM KARŞILIĞI <i>ROD PROFILE STRIKES FOR OUTWARD OPENING</i>	KOLİ MİKTARI/Package Adet / Piece	
ASI-WH 001B			ASI-GB 001		
KARE MİLLİ PENCERE KOLU - İKİLİ TAKIM <i>WINDOW HANDLE WITH LOCK</i>	KOLİ MİKTARI/Package Takım / Set		DIŞA AÇILIM KOL MEKANİZMASI <i>LOCKING FOR WINDOW FOR OUTWARD OPENING</i>	KOLİ MİKTARI/Package Adet / Piece	
ASI-DH 002			ASI-153 35		
KAPI KOLU <i>DOOR HANDLE</i>	KOLİ MİKTARI/Package Adet / Piece		DİLLİ KİLİT <i>MOURTISE LOCK WITH CYLINDER</i>	KOLİ MİKTARI/Package Adet / Piece	

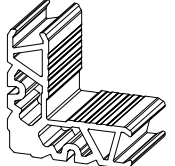
AKSESUAR LİSTESİ - ACCESSORIES LIST

ASI-LS 90185D			ASI-155U25		
DİLLİ KİLİT KARŞILIĞI LOCK STRIKES	KOLİ MİKTARI/Package Adet / Piece		ÇARPMA KAPI MAKARALI KİLİT SWING DOOR MOURTISE LOCK WITH ROLLER	KOLİ MİKTARI/Package Adet / Piece	
ASI-155 35			ASI-BRL 68		
MAKARALI KİLİT MOURTISE LOCK WITH ROLLER	KOLİ MİKTARI/Package Adet / Piece		ÇARPMA KAPI 68 LİK BAREL SWING DOOR CYLINDER 68	KOLİ MİKTARI/Package Adet / Piece	
ASI-LS 90185M			AK 545		
MAKARALI KİLİT KARŞILIĞI ROLLER LOCK STRIKES	KOLİ MİKTARI/Package Adet / Piece		ÇARPMA KAPI SÜRGÜ SWING DOOR BOLT	KOLİ MİKTARI/Package Adet / Piece	
ASI-BRL 90			C55 HOK		
90 LİK BAREL CYLINDER 90	KOLİ MİKTARI/Package Adet / Piece		ADAPTÖR KAPAĞI ADAPTER COVER	KOLİ MİKTARI/Package alt-üst 1 takım	
ASI-225			ASI-SB 19		
BAREL AYNASI (Beyaz,Siyah,Gri) DOOR HANDLE CYLINDER (White,Black,Grey)	KOLİ MİKTARI/Package Adet / Piece		KÖŞE GÖNYESİ CORNER ALIGNMENT	KOLİ MİKTARI/Package 1000 Adet / Piece	
ASI-B 2217			ASI-SB 19.1		
SÜRGÜ KİLİTLEME-KISA SASH FIXING LOCK-SHORT	KOLİ MİKTARI/Package 240 Adet / Piece		KÖŞE GÖNYESİ CORNER ALIGNMENT	KOLİ MİKTARI/Package 1000 Adet / Piece	
ASI-B 2215			ASI-MO 21		
SÜRGÜ KİLİTLEME-UZUN SASH FIXING LOCK-LONG	KOLİ MİKTARI/Package 120 Adet / Piece		PLASTİK KÖŞE GÖNYESİ CORNER ALIGNMENT	KOLİ MİKTARI/Package Adet / Piece	
ASI-DH 40KB			ASI-KT 1142		
ÇEKME KAPI KOLU DOOR HANDLE	KOLİ MİKTARI/Package Adet / Piece		KÖŞE TAKOZU CORNER JOINT	KOLİ MİKTARI/Package Adet / Piece	
ASI-DH 60Y			ASI-KT 1455		
ÇEKME KAPI KOLU DOOR HANDLE	KOLİ MİKTARI/Package Adet / Piece		KÖŞE TAKOZU CORNER JOINT	KOLİ MİKTARI/Package Adet / Piece	
ASI-YKM 001			ASI-KT 2342		
ÇARPMA KAPI MENTEŞE SWING DOOR HINGE	KOLİ MİKTARI/Package Adet / Piece		KÖŞE TAKOZU CORNER JOINT	KOLİ MİKTARI/Package Adet / Piece	

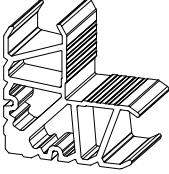
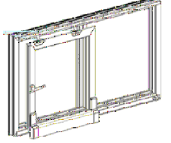
AKSESUAR LİSTESİ - ACCESSORIES LIST

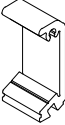
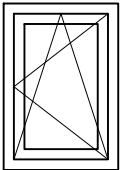
ASI-KT 4342			ASI-MEK VW		
KÖŞE TAKOZU <i>CORNER JOINT</i>	KOLİ MİKTARI/Package Adet / Piece		PARALEL SÜRME MEKANİZMASI <i>TILT&SLIDE OPENING</i>	KOLİ MİKTARI/Package Takım / Set	
ASI-KT 5542			ASI-WDC 01		
KÖŞE TAKOZU <i>CORNER JOINT</i>	KOLİ MİKTARI/Package Adet / Piece		YAĞMUR TAHLİYE KAPAĞI <i>WATER REJECT COVER</i>	KOLİ MİKTARI/Package Adet / Piece	
ASI-P 100.1					
ORTA KAYIT BAĞLANTI <i>T JOINT FIXING</i>	KOLİ MİKTARI/Package 250 Adet / Piece				
ASI-DB 9111					
DİK BAĞLANTI <i>T JOINT</i>	KOLİ MİKTARI/Package Adet / Piece				
ASI-DB 9123					
DİK BAĞLANTI <i>T JOINT</i>	KOLİ MİKTARI/Package Adet / Piece				
ASI-DB 9164					
DİK BAĞLANTI <i>T JOINT</i>	KOLİ MİKTARI/Package Adet / Piece				
ASI-DB 9172					
DİK BAĞLANTI <i>T JOINT</i>	KOLİ MİKTARI/Package Adet / Piece				
ASI-SS 01					
KANAT DESTEK TAKOZU <i>SASH SUPPORT BOTTOM</i>	KOLİ MİKTARI/Package Takım / Set				
ASI-ALU TT					
ÇİFT EKSEN AÇILIM MEKANİZMASI <i>TILT&TURN OPENING</i>	KOLİ MİKTARI/Package Adet / Piece				
ASI-LTT K01					
ÇİFT KANAT AÇILIM PASİF KANAT LEVYE KOLU <i>INACTIVE SASH HIDDEN HANDLE</i>	KOLİ MİKTARI/Package Takım / Set				

C55

YALITIMSIZ KAPI-PENCERE SİSTEMİ
UNINSULATED WINDOW & DOOR SYSTEM

ASISTAL



PROFİL DETAYLARI
PROFILE DETAILS

C55 - 1,8mm

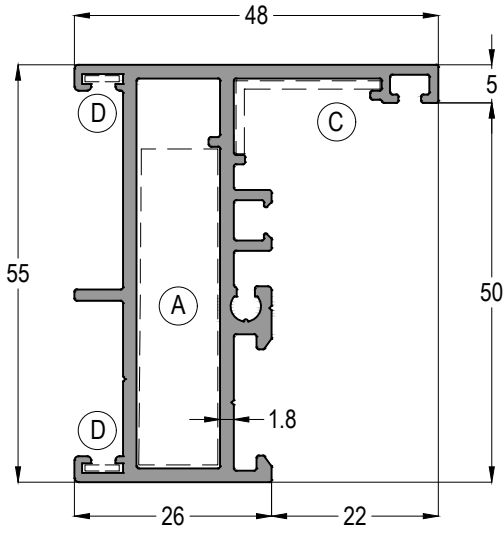

YALITIMSIZ KAPI-PENCERE SİSTEMİ
UNINSULATED WINDOW & DOOR SYSTEM

ASISTAL



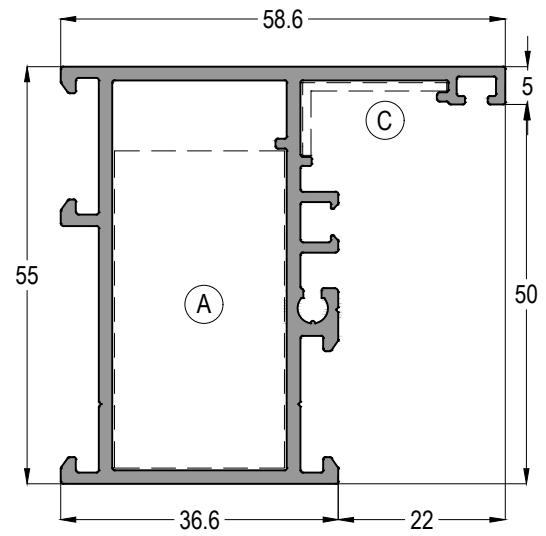

C55 01			Jx cm ⁴	Jy cm ⁴
			13,93	4,42
			AĞIRLIK / Weight	
ASI-KT 1142	ASI-MO 21	ASI-SB 19	1,021 kg/mt	

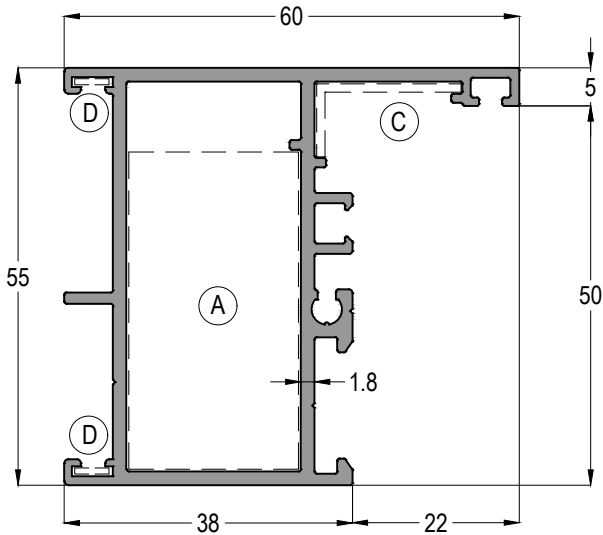

C55 04			Jx cm ⁴	Jy cm ⁴
			18,01	8,53
			AĞIRLIK / Weight	
ASI-KT 2342	ASI-MO 21		1,134 kg/mt	







C55 02			Jx cm ⁴	Jy cm ⁴
			17,03	9,74
			AĞIRLIK / Weight	
ASI-KT 2342	ASI-MO 21	ASI-SB 19	1,140 kg/mt	

C55 - 1,8mm

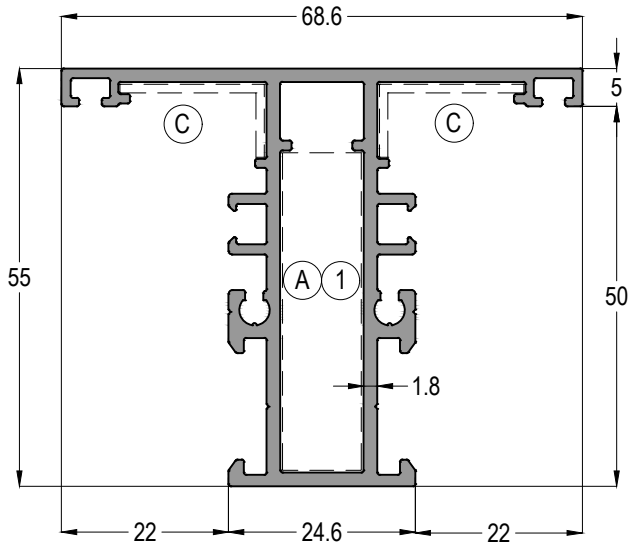

YALITIMSIZ KAPI-PENCERE SİSTEMİ
UNINSULATED WINDOW & DOOR SYSTEM

ASISTAL

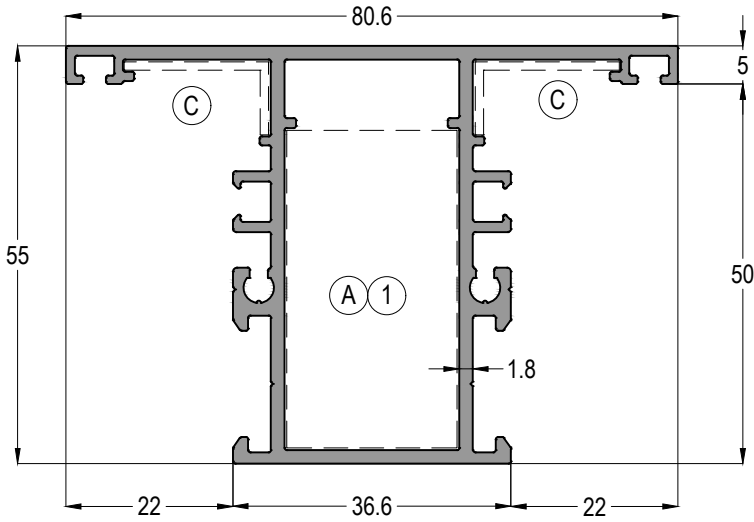

C55 21			Jx cm ⁴	Jy cm ⁴
			16,26	8,28
 ASI-KT 1142	 ASI-MO 21	 ASI-DB 9111	AĞIRLIK / Weight	
			1,220 kg/mt	



C55 22			Jx cm ⁴	Jy cm ⁴
			19,44	15,87
 ASI-KT 2342	 ASI-MO 21	 ASI-DB 9123	AĞIRLIK / Weight	
			1,337 kg/mt	

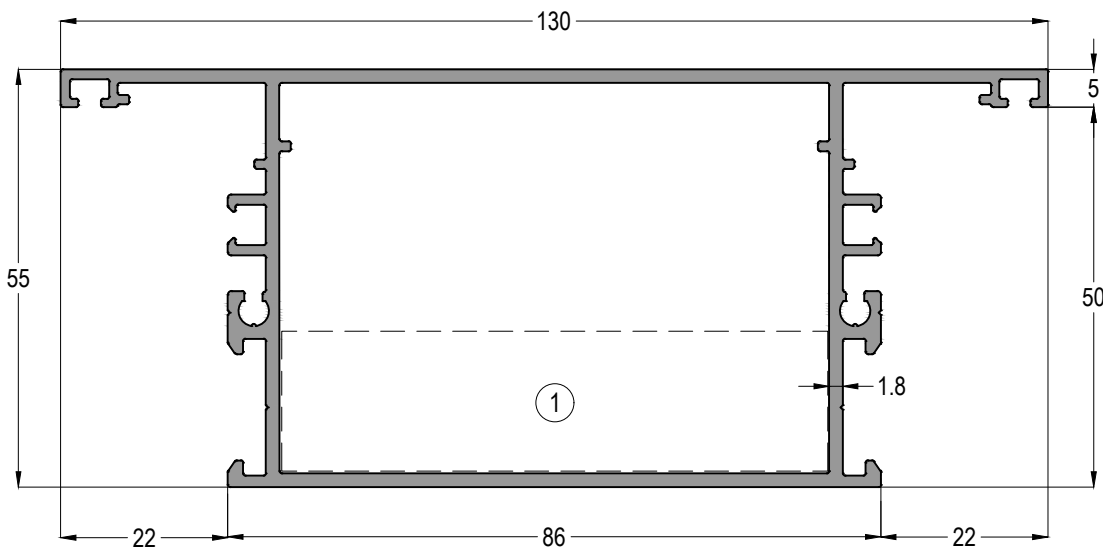



C55 23			Jx cm ⁴	Jy cm ⁴
			32,36	88,07
			AĞIRLIK / Weight	
			1,817 kg/mt	

Profil ağırlıklarımız teorik olup; teslim anındaki tartımız geçerlidir.
Profile weights are theoretical and the weight at the time of delivery is valid.

C55 - 1,8mm

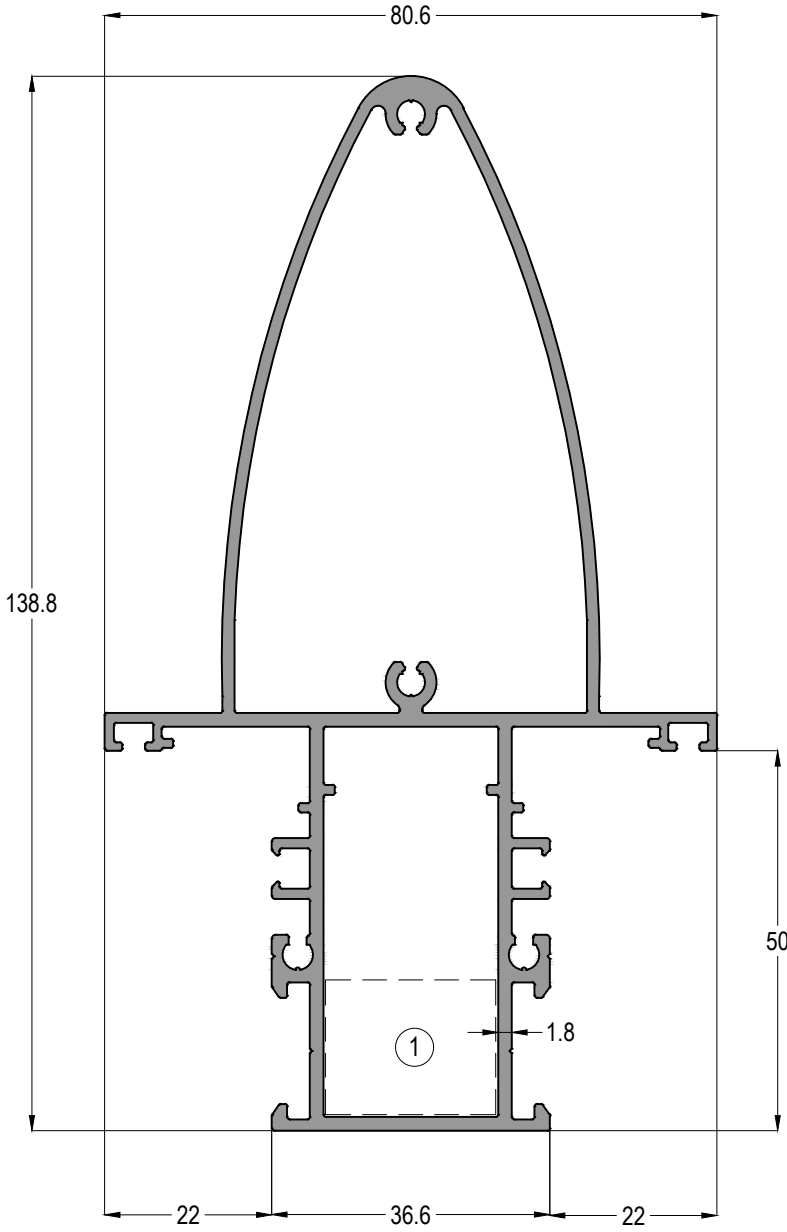
YALITIMSIZ KAPI-PENCERE SİSTEMİ
UNINSULATED WINDOW & DOOR SYSTEM



C55 24	Jx cm ⁴	Jy cm ⁴
	132,88	25,86
 ASI-DB 9123	AĞIRLIK / Weight	
	2,255 kg/mt	

C55 25	Jx cm ⁴	Jy cm ⁴
	70,54	25,44
 ASI-DB 9123	AĞIRLIK / Weight	
	2,055 kg/mt	

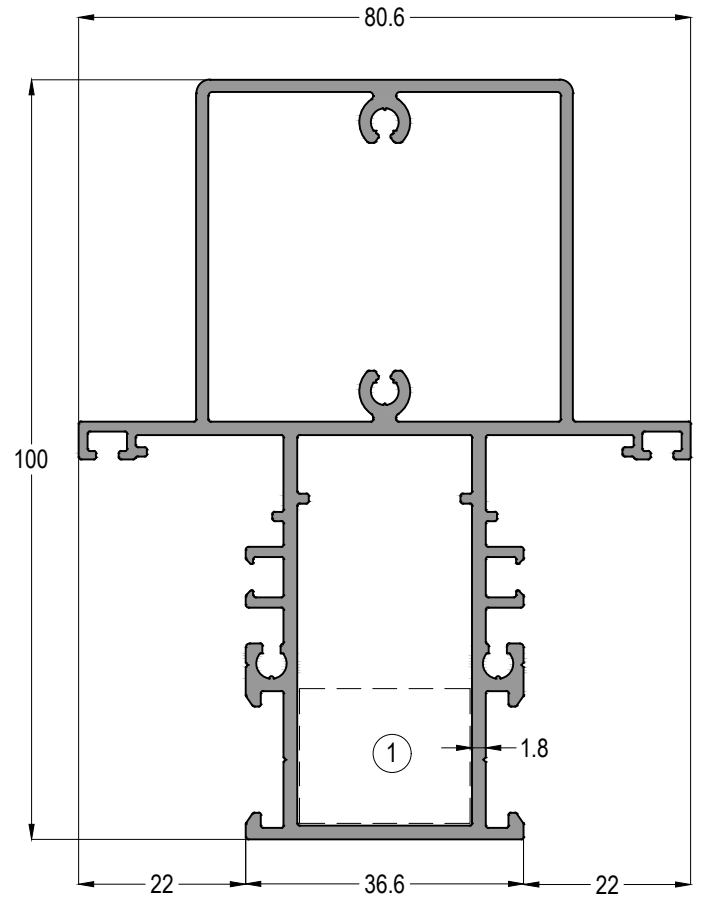





Profil ağırlıklarımız teorik olup; teslim anındaki tartımız geçerlidir.
Profile weights are theoretical and the weight at the time of delivery is valid.

C55 - 1,8mm

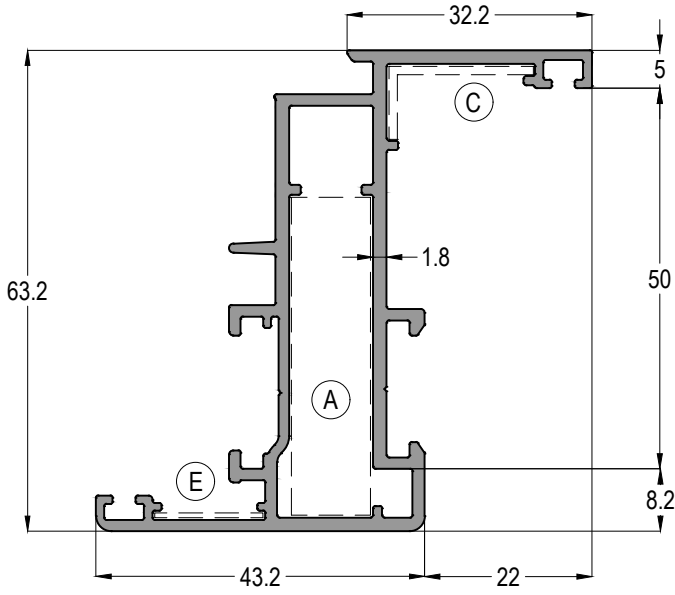

YALITIMSIZ KAPI-PENCERE SİSTEMİ
UNINSULATED WINDOW & DOOR SYSTEM

ASISTAL



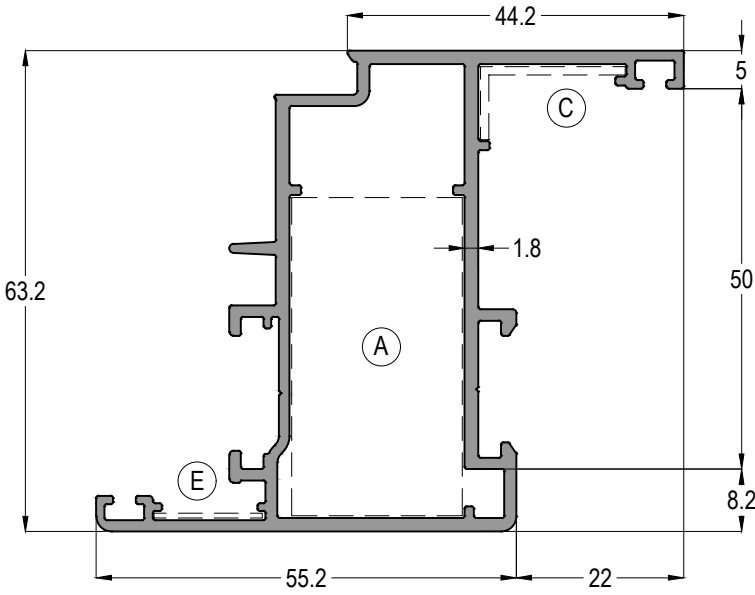

C55 11			Jx cm ⁴	Jy cm ⁴
			21,45	7,07
 ASI-KT 1142	 ASI-MO 21	 ASI-SB 19.1	AĞIRLIK / Weight	
			1,145 kg/mt	

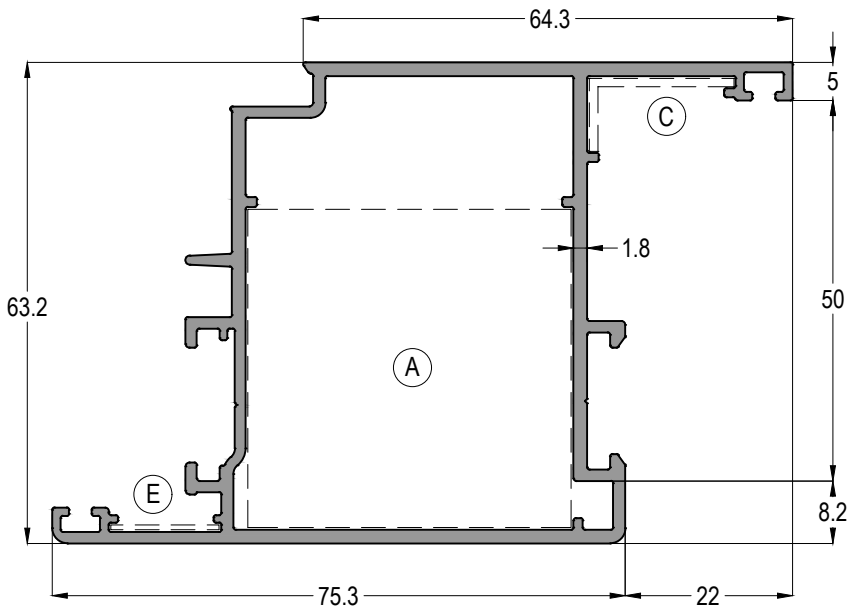

C55 12			Jx cm ⁴	Jy cm ⁴
			26,02	9,94
 ASI-KT 2342	 ASI-MO 21	 ASI-SB 19.1	AĞIRLIK / Weight	
			1,277 kg/mt	



C55 13			Jx cm ⁴	Jy cm ⁴
			44,50	21,57
 ASI-KT 4342	 ASI-MO 21	 ASI-SB 19.1	AĞIRLIK / Weight	
			1,472 kg/mt	



Profil ağırlıklarımız teorik olup; teslim anındaki tartımız geçerlidir.
Profile weights are theoretical and the weight at the time of delivery is valid.

C55 - 1,8mm

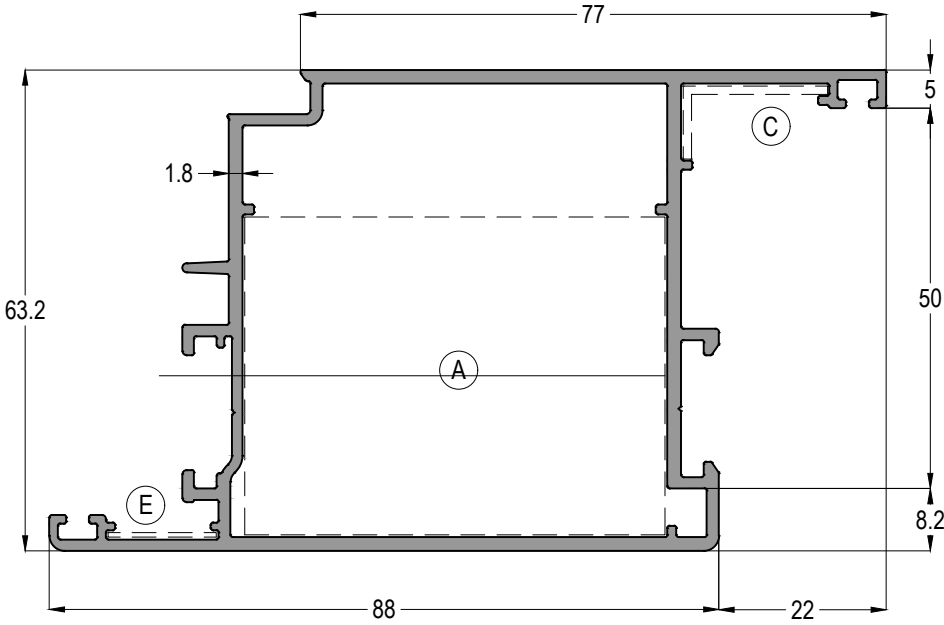

YALITIMSIZ KAPI-PENCERE SİSTEMİ
UNINSULATED WINDOW & DOOR SYSTEM

ASISTAL

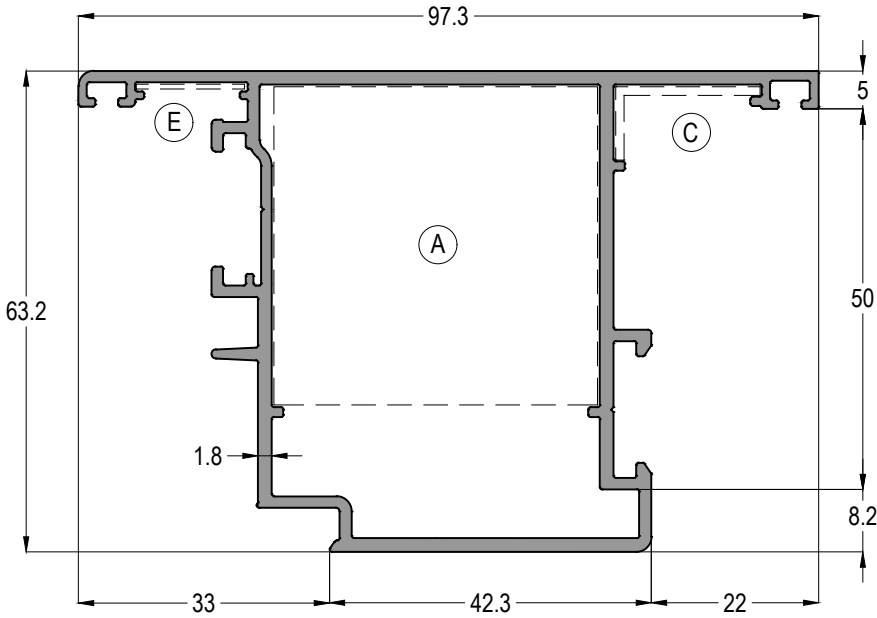

C55 15		Jx cm ⁴	Jy cm ⁴
		59,11	29,03
 ASI-KT 5542	 ASI-MO 21	 ASI-SB 19.1	AĞIRLIK / Weight
			1,596 kg/mt



C55 14		Jx cm ⁴	Jy cm ⁴
		31,11	33,14
 ASI-KT 4342	 ASI-MO 21	 ASI-SB 19.1	AĞIRLIK / Weight
			1,469 kg/mt

Profil ağırlıklarımız teorik olup; teslim anındaki tartımız geçerlidir.
Profile weights are theoretical and the weight at the time of delivery is valid.

C55 - 1,8mm

YALITIMSIZ KAPI-PENCERE SİSTEMİ
UNINSULATED WINDOW & DOOR SYSTEM

ASISTAL

C55 41

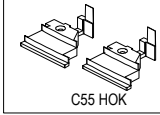

C55 HOK

AĞIRLIK / Weight

1,037 kg/mt

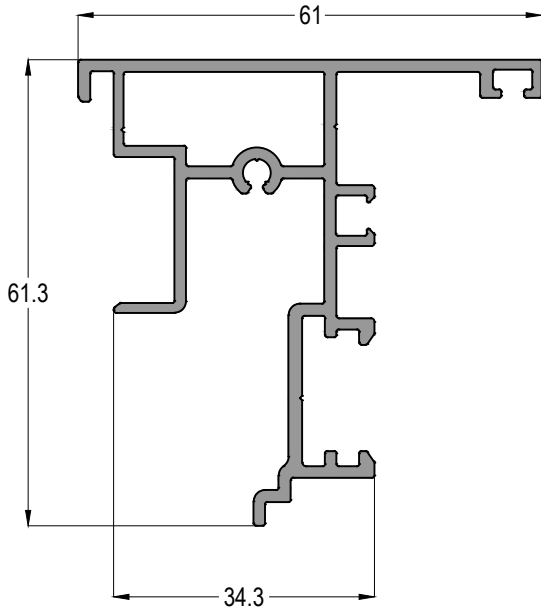

C55 43



ASI-KT 2342

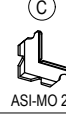

ASI-MO 21

AĞIRLIK / Weight

1,080 kg/mt

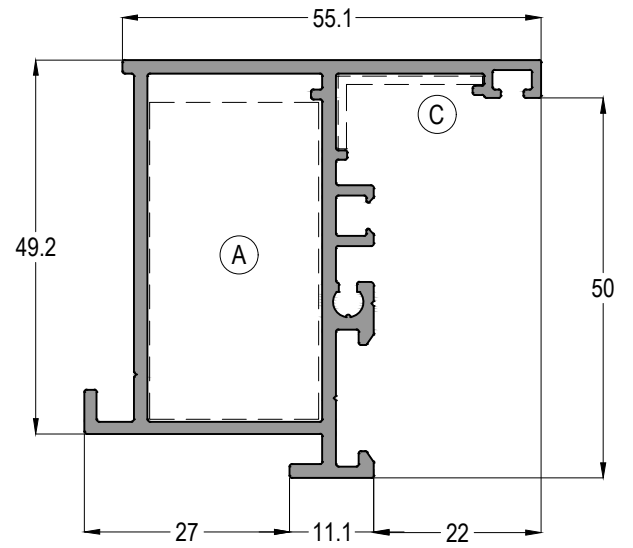

C55 44



ASI-KT 2351



ASI-SB 19

AĞIRLIK / Weight

0,942 kg/mt

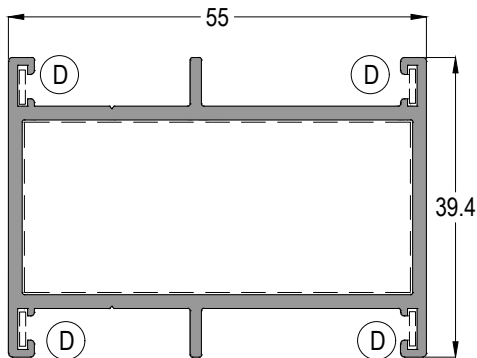

C55 45

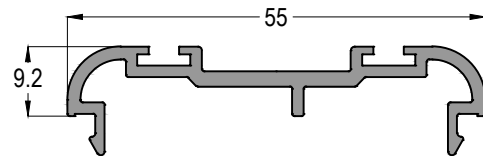

AĞIRLIK / Weight

0,446 kg/mt

C55 - 1,8mm

YALITIMSIZ KAPI-PENCERE SİSTEMİ
UNINSULATED WINDOW & DOOR SYSTEM

ASISTAL

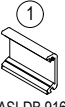
C55 31	Jx cm ⁴	Jy cm ⁴
	104,06	36,64
 ASI-DB 9164	AĞIRLIK / Weight	
	1,941 kg/mt	

C55 48	
	AĞIRLIK / Weight
	0,335 kg/mt

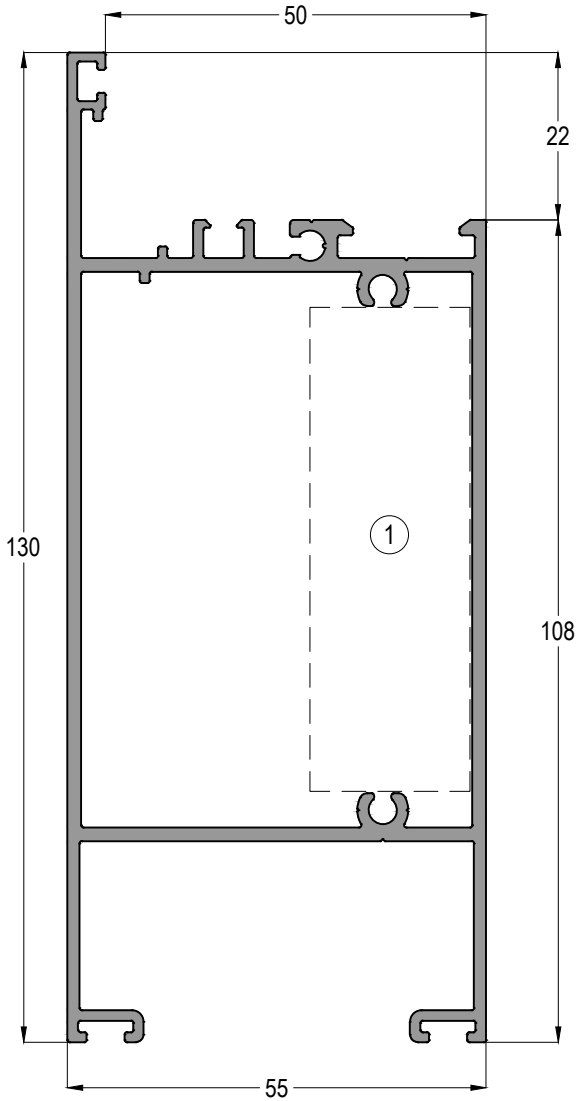

C55 46	
	AĞIRLIK / Weight
	0,689 kg/mt

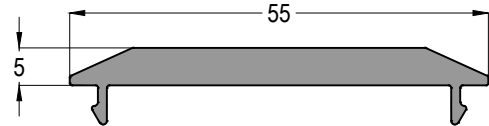

C55 - 2mm



YALITIMSIZ KAPI-PENCERE SİSTEMİ
UNINSULATED WINDOW & DOOR SYSTEM

ASISTAL



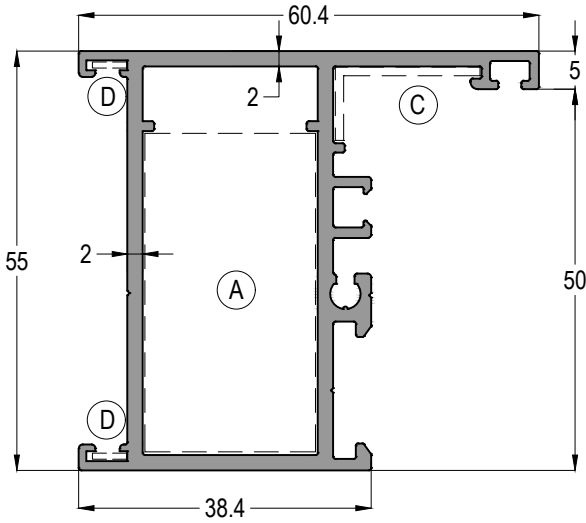

2 mm ET KALINLIĞINDA SİSTEM PROFİLLERİ

2 mm THICKNESS SYSTEM PROFILES

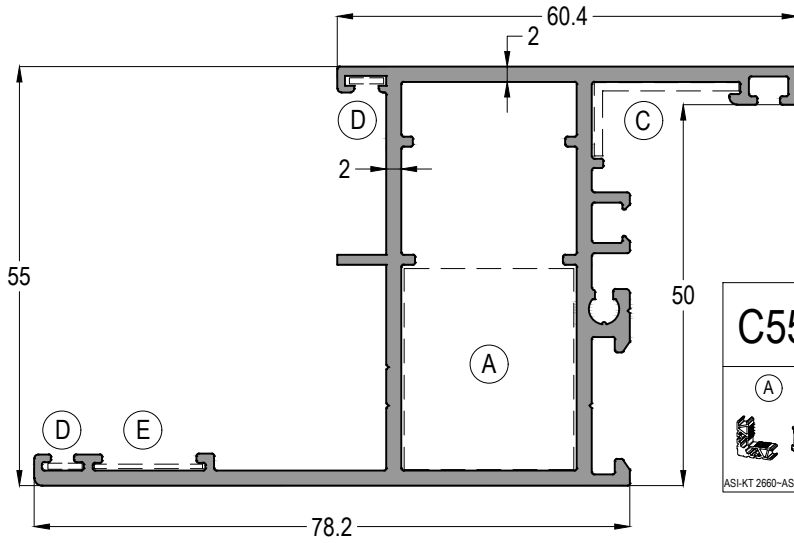

C55 202			Jx cm ⁴	Jy cm ⁴
			21,38	9,19
 ASI-KT 2342	 ASI-MO 21	 ASI-SB 19	AĞIRLIK / Weight	
			1,217 kg/mt	

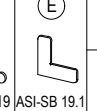

C55 203					AĞIRLIK / Weight
 ASI-KT 2660-ASI-PB 2326	 ASI-KT 2307	 ASI-MO 21	 ASI-SB 19	 ASI-SB 19.1	1,505 kg/mt

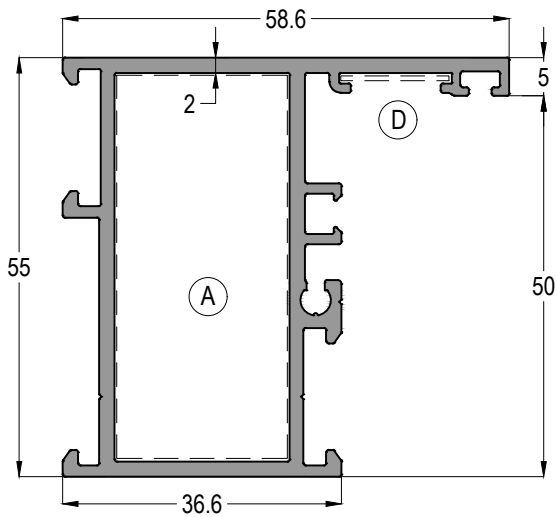

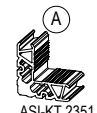
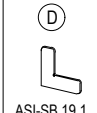
C55 204		Jx cm ⁴	Jy cm ⁴
		19,69	8,95
 ASI-KT 2351	 ASI-SB 19.1	AĞIRLIK / Weight	
		1,217 kg/mt	

Profil ağırlıklarımız teorik olup; teslim anındaki tartımız geçerlidir.
Profile weights are theoretical and the weight at the time of delivery is valid.

C55 - 2mm



YALITIMSIZ KAPI-PENCERE SİSTEMİ
UNINSULATED WINDOW & DOOR SYSTEM

ASISTAL

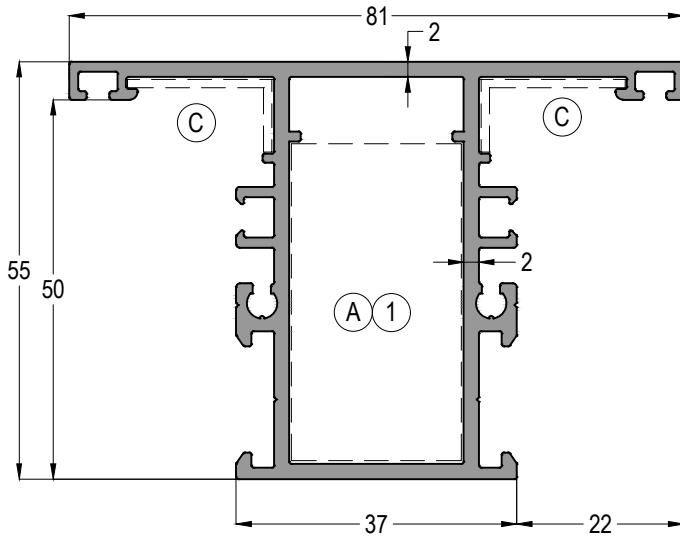

2 mm ET KALINLIĞINDA SİSTEM PROFİLLERİ

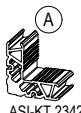
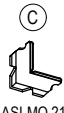
2 mm THICKNESS SYSTEM PROFILES

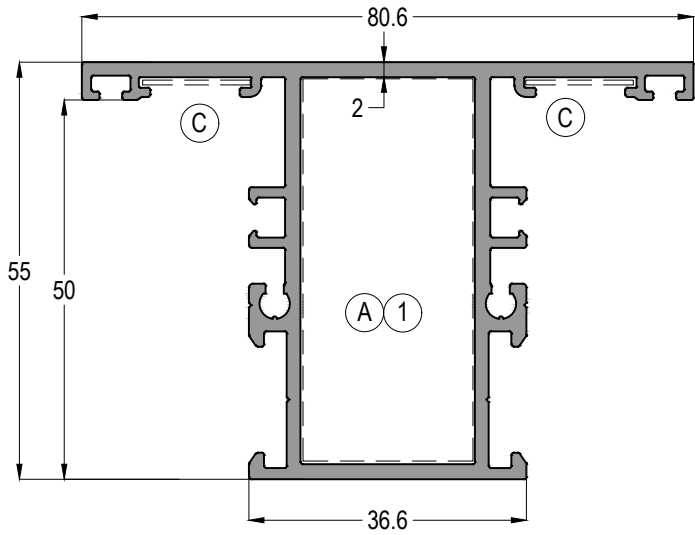

C55 222			Jx cm ⁴	Jy cm ⁴
			21,01	16,97
 ASI-KT 2342	 ASI-MO 21	 ASI-DB 9123	AĞIRLIK / Weight	
			1,442 kg/mt	

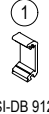

C55 223			Jx cm ⁴	Jy cm ⁴
			20,95	17,41
 ASI-KT 2351	 ASI-SB 19.1	 ASI-DB 9123	AĞIRLIK / Weight	
			1,437 kg/mt	

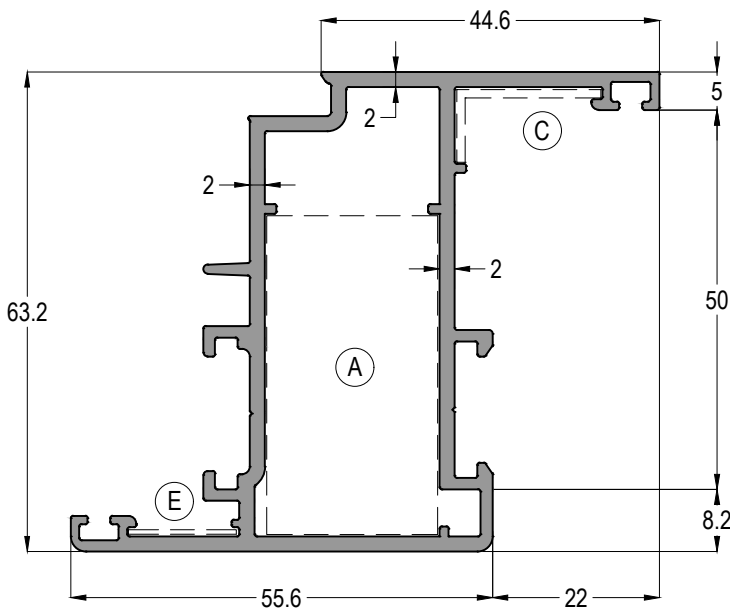

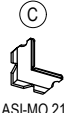
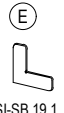
C55 212			Jx cm ⁴	Jy cm ⁴
			34,00	10,59
 ASI-KT 2342	 ASI-MO 21	 ASI-SB 19.1	AĞIRLIK / Weight	
			1,439 kg/mt	

Profil ağırlıklarımız teorik olup; teslim anındaki tartımız geçerlidir.
Profile weights are theoretical and the weight at the time of delivery is valid.



C55 - 2mm

YALITIMSIZ KAPI-PENCERE SİSTEMİ
UNINSULATED WINDOW & DOOR SYSTEM

ASISTAL



2 mm ET KALINLIĞINDA SİSTEM PROFİLLERİ

2 mm THICKNESS SYSTEM PROFILES

C55 213			Jx cm ⁴	Jy cm ⁴
			49,91	24,03
			AĞIRLIK / Weight	
ASI-KT 4342	ASI-MO 21	ASI-SB 19.1	1,658 kg/mt	

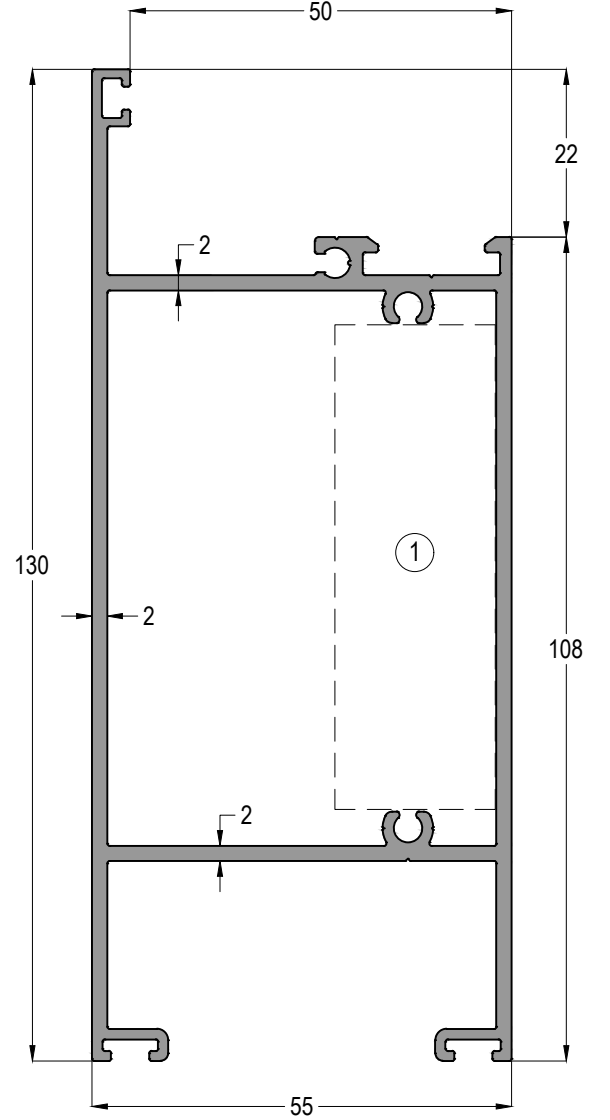
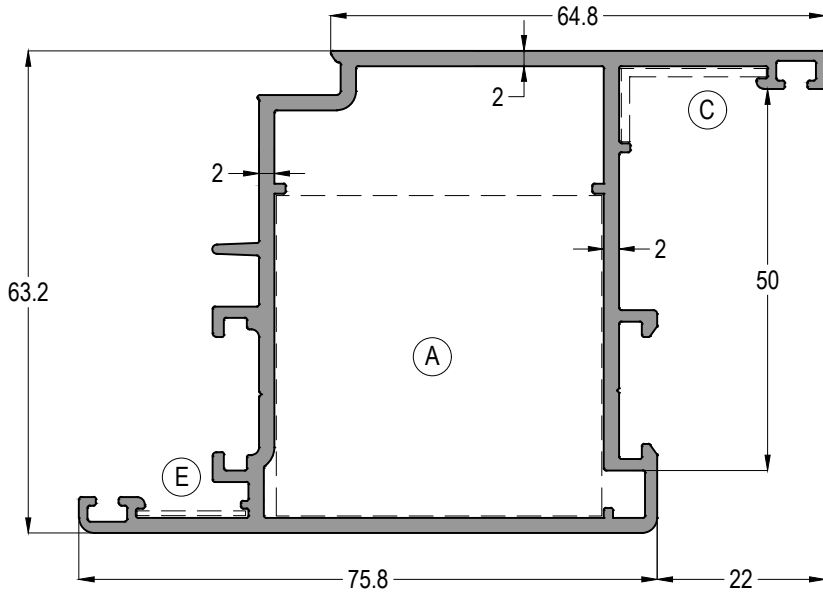
C55 231			Jx cm ⁴	Jy cm ⁴
			109,58	39,47
			AĞIRLIK / Weight	
ASI-DB 9164			2,076 kg/mt	



C55 214			Jx cm ⁴	Jy cm ⁴
			38,68	33,88
			AĞIRLIK / Weight	
ASI-KT 4342	ASI-MO 21	ASI-SB 19.1	1,672 kg/mt	

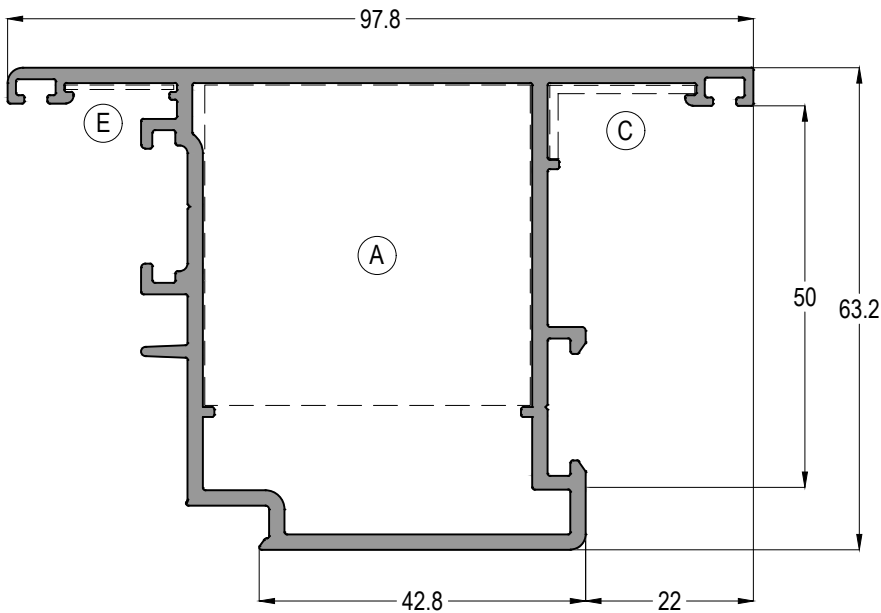

Profil ağırlıklarımız teorik olup; teslim anındaki tartımız geçerlidir.
Profile weights are theoretical and the weight at the time of delivery is valid.

C55 - 1,4mm

YALITIMSIZ KAPI-PENCERE SİSTEMİ
UNINSULATED WINDOW & DOOR SYSTEM

ASISTAL

1.4 mm ET KALINLIĞINDA SİSTEM PROFİLLERİ

1.4 mm THICKNESS SYSTEM PROFILES

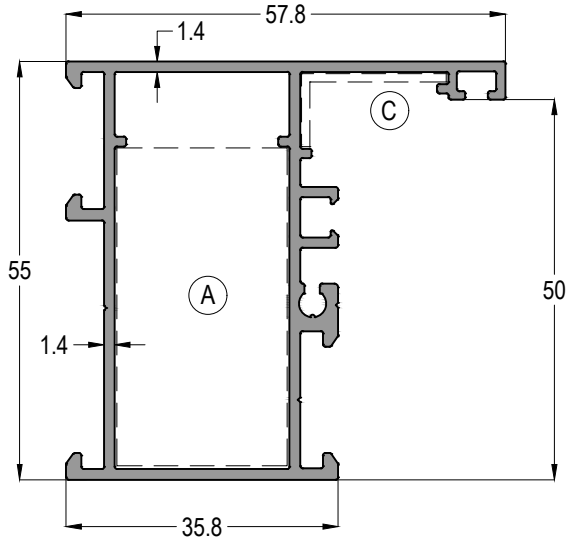

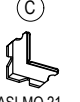

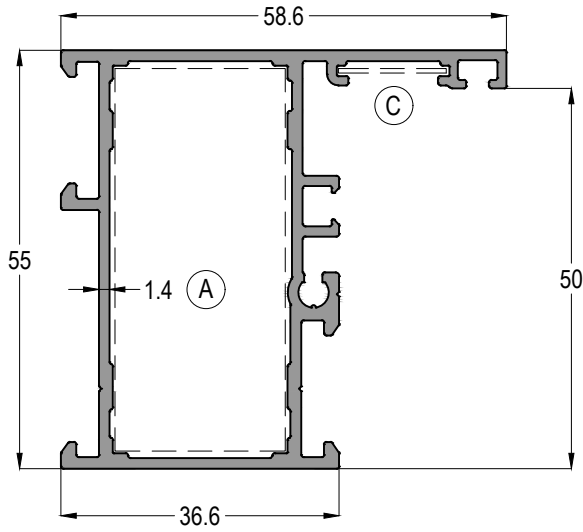
C55 104	Jx cm ⁴	Jy cm ⁴
	15,05	7,28
 ASI-KT 2342	 ASI-MO 21	AĞIRLIK / Weight
		0,965 kg/mt

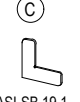

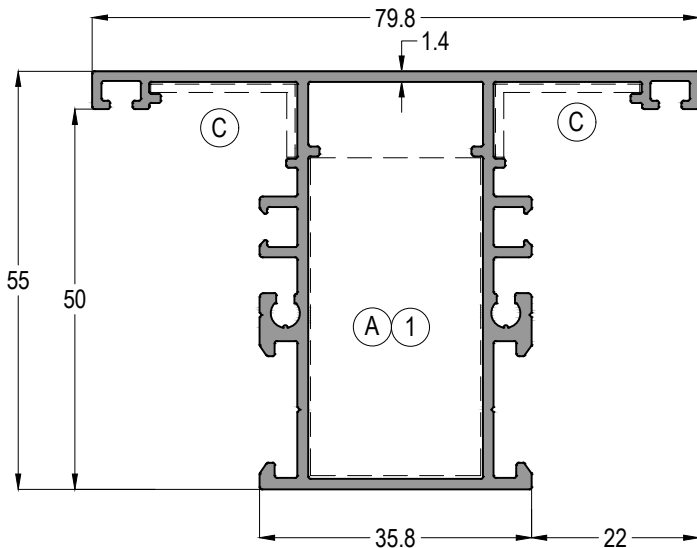
C55 105	Jx cm ⁴	Jy cm ⁴
	16,50	8,95
 ASI-KT 2351	 ASI-SB 19.1	AĞIRLIK / Weight
		1,017 kg/mt

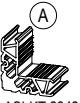

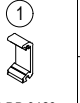
C55 122	Jx cm ⁴	Jy cm ⁴
	16,28	13,84
 ASI-KT 2342	 ASI-MO 21	 ASI-DB 9123
AĞIRLIK / Weight		
1,140 kg/mt		

Profil ağırlıklarımız teorik olup; teslim anındaki tartımız geçerlidir.
Profile weights are theoretical and the weight at the time of delivery is valid.

C55 - 1,4mm



YALITIMSIZ KAPI-PENCERE SİSTEMİ
UNINSULATED WINDOW & DOOR SYSTEM

ASISTAL

1.4 mm ET KALINLIĞINDA SİSTEM PROFİLLERİ

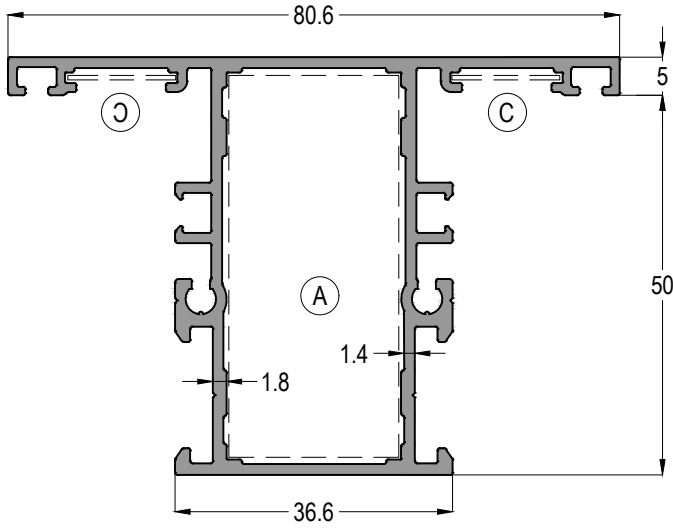
1.4 mm THICKNESS SYSTEM PROFILES

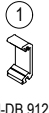

C55 123	Jx cm ⁴	Jy cm ⁴
	17,83	15,09
 (A)	 (C)	 (1)
AĞIRLIK / Weight		
1,215 kg/mt		

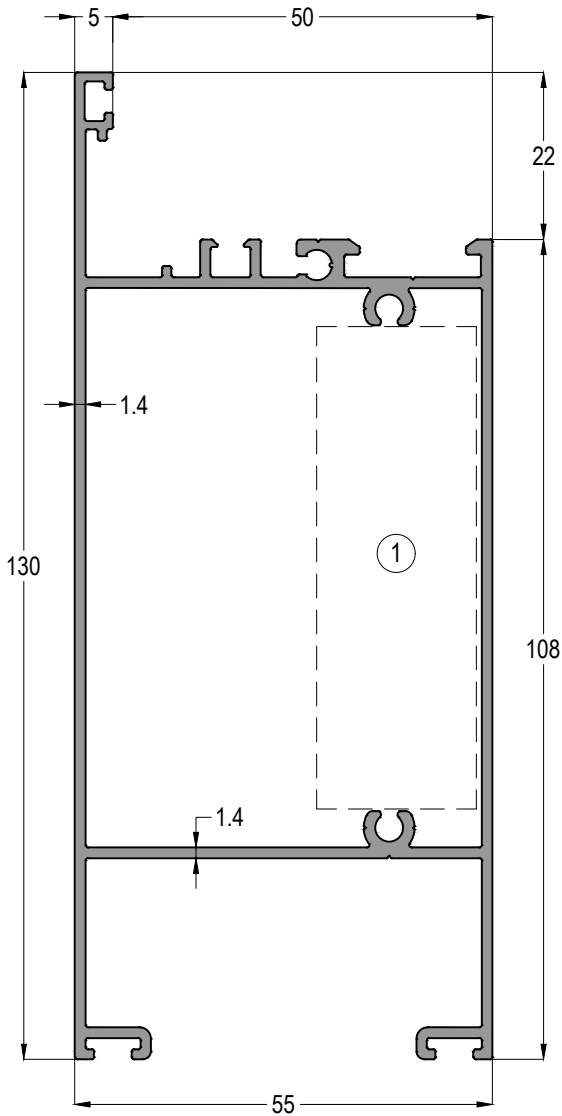

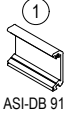
C55 131	Jx cm ⁴	Jy cm ⁴
	109,58	39,47
 (1)	AĞIRLIK / Weight	
1,631 kg/mt		

Profil ağırlıklarımız teorik olup; teslim anındaki tartımız geçerlidir.
Profile weights are theoretical and the weight at the time of delivery is valid.



C55 - 1,4mm



YALITIMSIZ KAPI-PENCERE SİSTEMİ
UNINSULATED WINDOW & DOOR SYSTEM

ASISTAL



1.4 mm ET KALINLIĞINDA SİSTEM PROFİLLERİ

1.4 mm THICKNESS SYSTEM PROFILES

C55 114			Jx cm ⁴	Jy cm ⁴
(A)	(C)	(E)	27,28	8,63
			AĞIRLIK / Weight	
ASI-KT 1754	ASI-MO 21	ASI-SB 19.1	1,182 kg/mt	

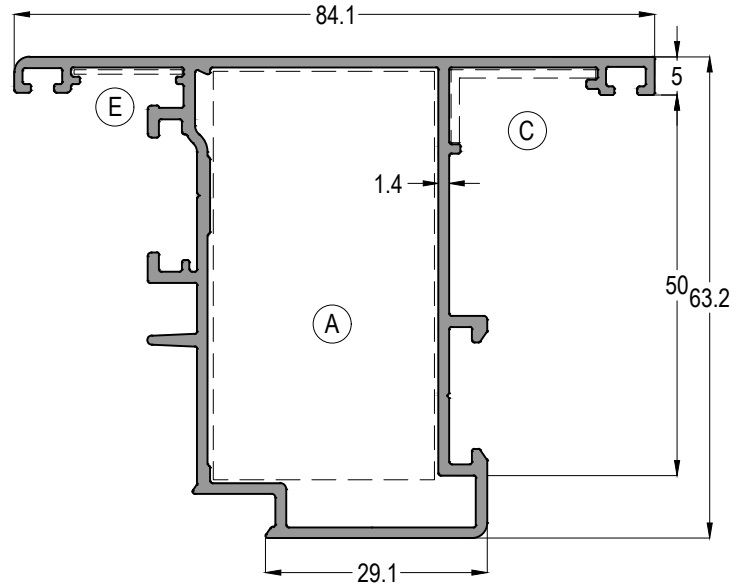
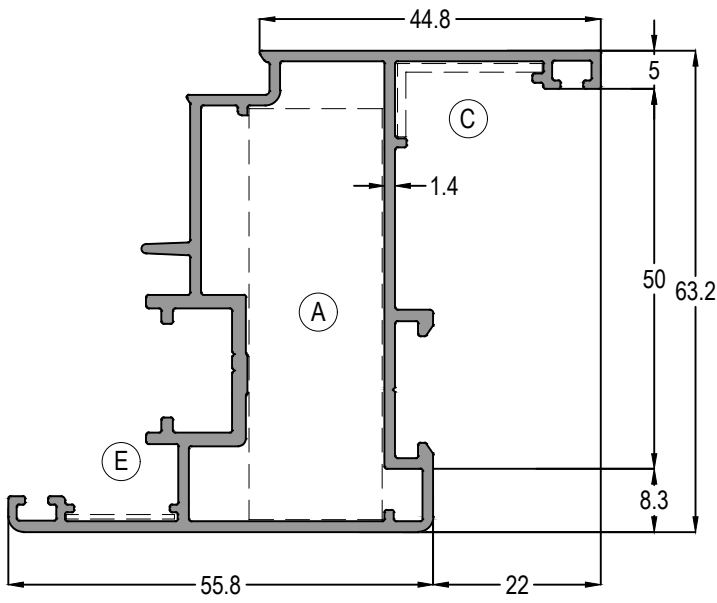
C55 117			Jx cm ⁴	Jy cm ⁴
(A)	(C)	(E)	23,13	17,38
			AĞIRLIK / Weight	
ASI-KT 1455	ASI-MO 21	ASI-SB 19.1	1,169 kg/mt	



C55 115			Jx cm ⁴	Jy cm ⁴
(A)	(C)	(C)	51,94	23,91
			AĞIRLIK / Weight	
ASI-KT 5542	ASI-MO 21	ASI-SB 19.1	1,355 kg/mt	

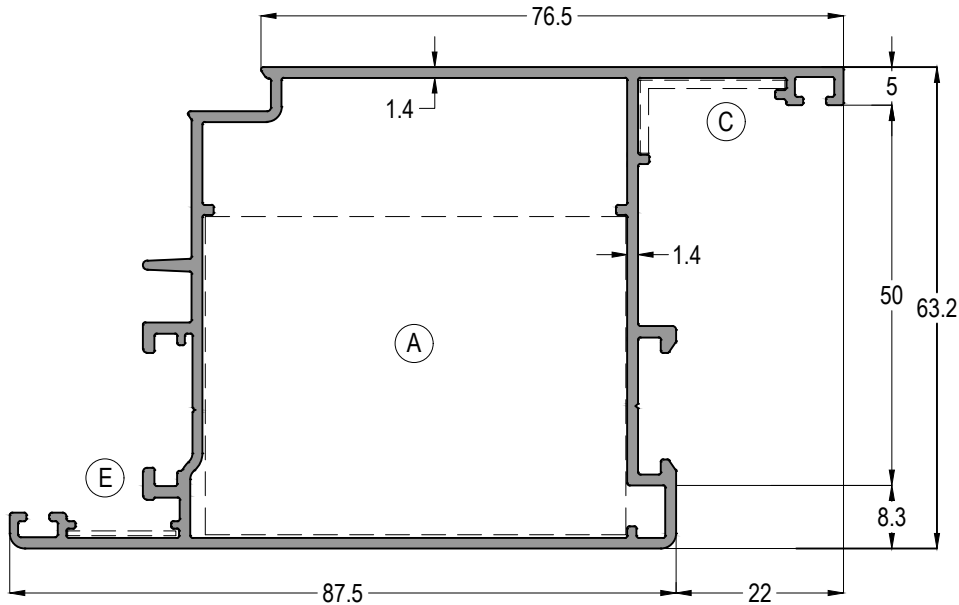

Profil ağırlıklarımız teorik olup; teslim anındaki tartımız geçerlidir.
Profile weights are theoretical and the weight at the time of delivery is valid.

C55 - 1,5mm / 1,6mm

YALITIMSIZ KAPI-PENCERE SİSTEMİ
UNINSULATED WINDOW & DOOR SYSTEM

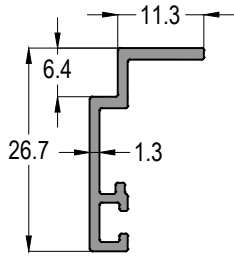

C55 47

0,184 kg/mt

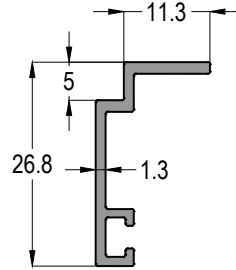

C55 49

0,179 kg/mt

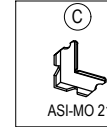
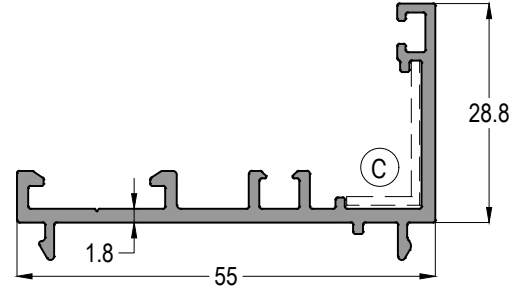

C55 55

0,570 kg/mt

C55 51	Jx cm ⁴	Jy cm ⁴
	10,80	14,75
AĞIRLIK / Weight		
0,845 kg/mt		

01-000500-15	
AĞIRLIK / Weight	
0,619 kg/mt	

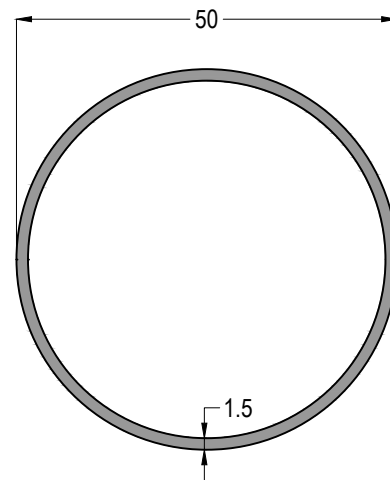
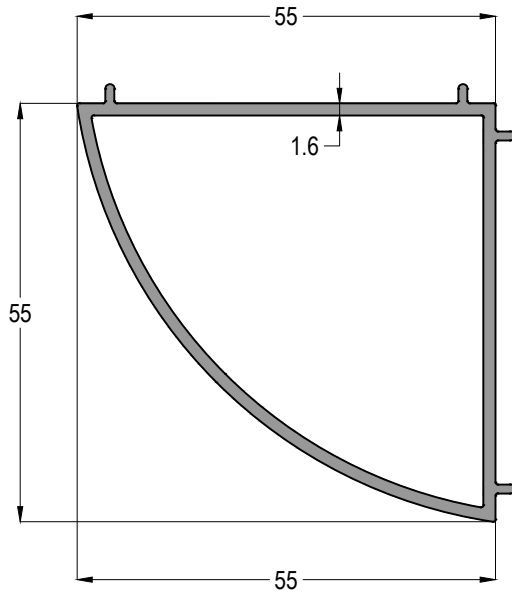

C55 - 1,2mm / 1,3mm

YALITIMSIZ KAPI-PENCERE SİSTEMİ
UNINSULATED WINDOW & DOOR SYSTEM

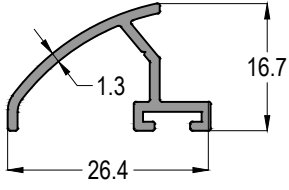

12-01
0,198 kg/mt

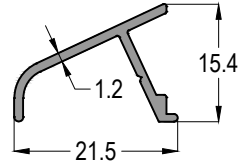

12-02
0,136 kg/mt

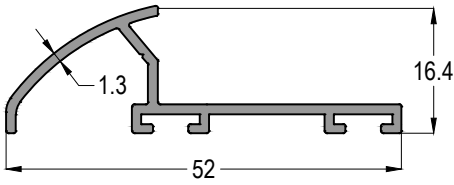

12-03
0,313 kg/mt

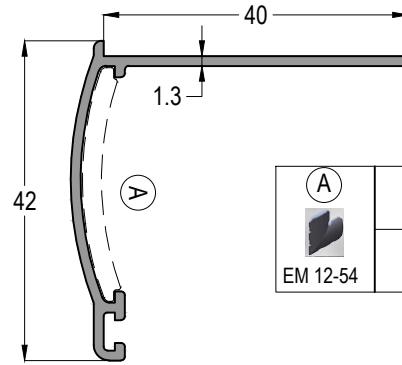

12-54
0,326 kg/mt

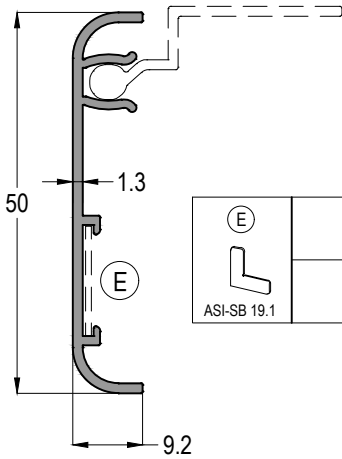

12-52
0,279 kg/mt

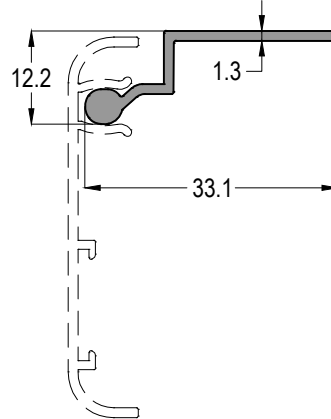

12-53
0,177 kg/mt

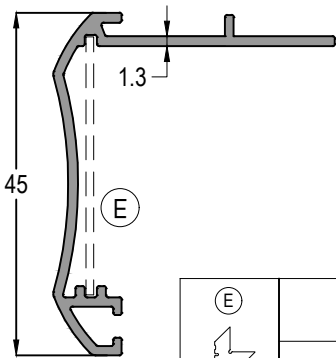

12-57
0,358 kg/mt

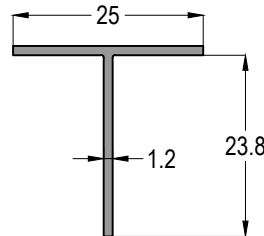

04-025025-12
0,159 kg/mt

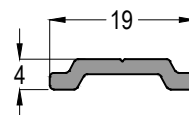

12-41
0,118 kg/mt

Profil ağırlıklarımız teorik olup; teslim anındaki tartımız geçerlidir.
Profile weights are theoretical and the weight at the time of delivery is valid.

C55 - 1,8mm

YALITIMSIZ KAPI-PENCERE SİSTEMİ
UNINSULATED WINDOW & DOOR SYSTEM

ASISTAL

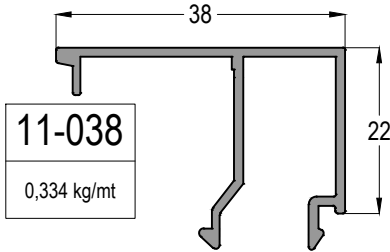
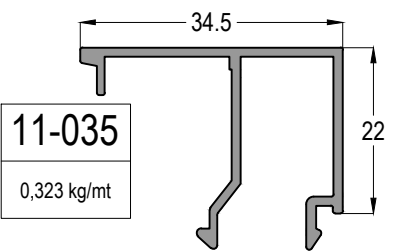
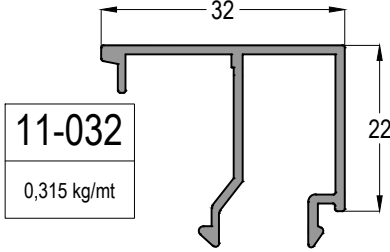
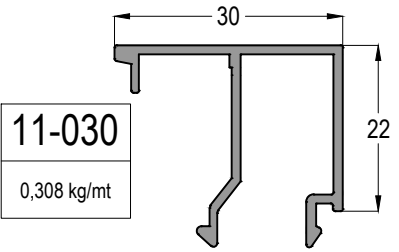
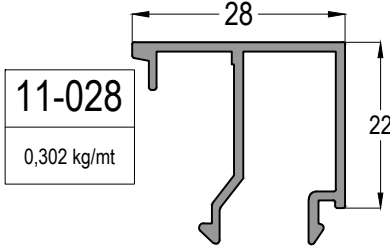
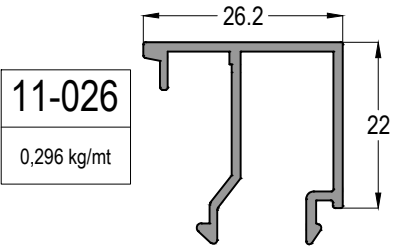
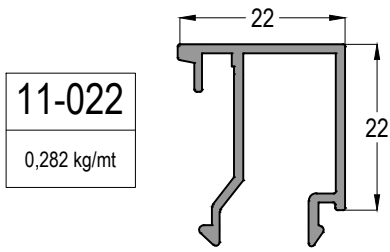
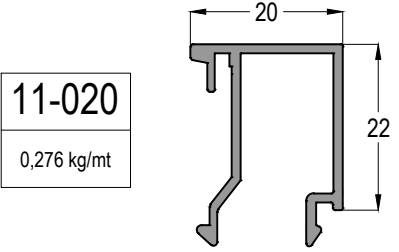
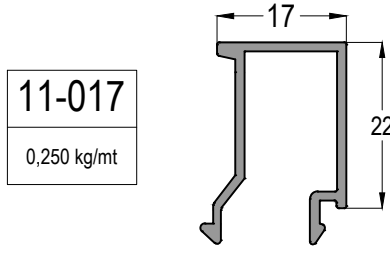
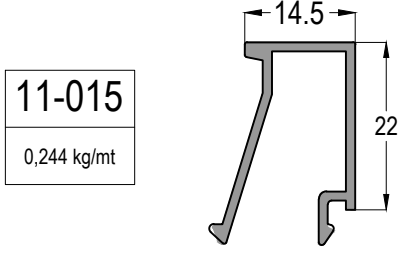
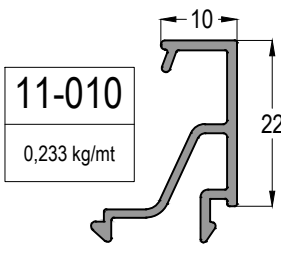
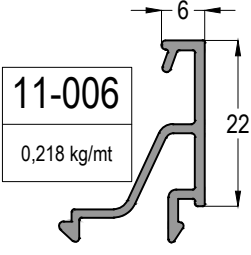
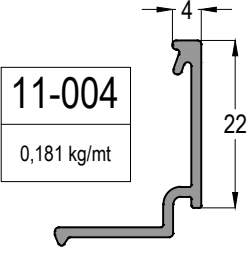

CAM KALINLIĞINA GÖRE CAM ÇİTASI SEÇİM TABLOSU
Glazing Bead Selection Table
according to the Glass Thickness

CAM KALINLIĞI Glass Thickness (mm)	CAM ÇİTASI Glazing Bead	İÇ CAM FİTİLİ Glass Gasket (IN)	DIŞ CAM FİTİLİ Glass Gasket (OUT)
4	11-038	EP2-02	EP1-01
5	11-038	EP2-01	EP1-01
6	11-038	KC-02	EP1-01
7	11-035	EP2-02	EP1-01
8	11-035	EP2-01	EP1-01
9	11-035	KC-02	EP1-01
10	11-032	EP2-02	EP1-01
11	11-032	EP2-01	EP1-01
12	11-032	KC-02	EP1-01
13	11-030	EP2-01	EP1-01
14	11-030	KC-02	EP1-01
15	11-028	EP2-01	EP1-01
16	11-028	KC-02	EP1-01
17	11-026	EP2-01	EP1-01
18	11-026	KC-02	EP1-01
20	11-022	EP2-02	EP1-01
21	11-022	EP2-01	EP1-01
22	11-022	KC-02	EP1-01
23	11-020	EP2-01	EP1-01
24	11-020	KC-02	EP1-01
26	11-017	EP2-01	EP1-01
27	11-017	KC-02	EP1-01
28	11-015	EP2-01	EP1-01
29	11-015	KC-02	EP1-01
32	11-010	EP2-02	EP1-01
33	11-010	EP2-01	EP1-01
34	11-010	KC-02	EP1-01
36	11-006	EP2-02	EP1-01
37	11-006	EP2-01	EP1-01
38	11-006	KC-02	EP1-01
39	11-004	EP2-01	EP1-01
40	11-004	KC-02	EP1-01

AÇILIM TİPLERİ - OPENING TYPES

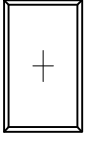

SABİT
FIXED

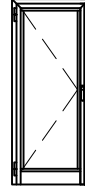

TEK KANAT İÇE AÇILIR KAPI
SINGLE INWARD OPENING DOOR

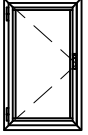

TEK AÇILIR KANAT
SINGLE OPENING SASH

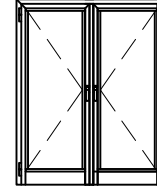

ÇİFT KANAT İÇE AÇILIR KAPI
DOUBLE INWARD OPENING DOOR

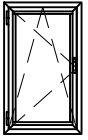

TEK KANAT ÇİFT EKSEN AÇILIM KANAT
SINGLE TILT-TURN OPENING SASH

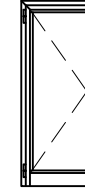

TEK KANAT DIŞA AÇILIR KAPI
SINGLE OUTWARD OPENING DOOR

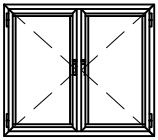

ÇİFT AÇILIR KANAT
DOUBLE OPENING SASH

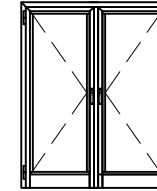

ÇİFT KANAT DIŞA AÇILIR KAPI
DOUBLE OUTWARD OPENING DOOR

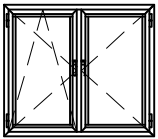

ÇİFT EKSEN AÇILIM ÇİFT KANAT
DOUBLE TILT-TURN OPENING SASH

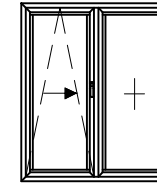

PARALEL SÜRME KAPI
PARALLEL SLIDING OPENING DOOR

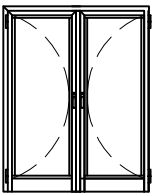

ÇARPMA KAPI
SWING DOOR

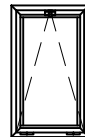

VASİSTAS AÇILIR KANAT
TILT OPENING SASH

C55

YALITIMSIZ KAPI-PENCERE SİSTEMİ
UNINSULATED WINDOW & DOOR SYSTEM

ASISTAL

SİSTEM DETAYLARI
SYSTEM DETAILS

PENCERE AÇILIM DETAYLARI
WINDOW OPENING DETAILS

1

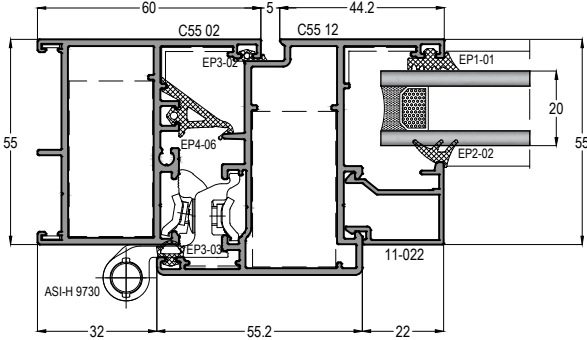

2

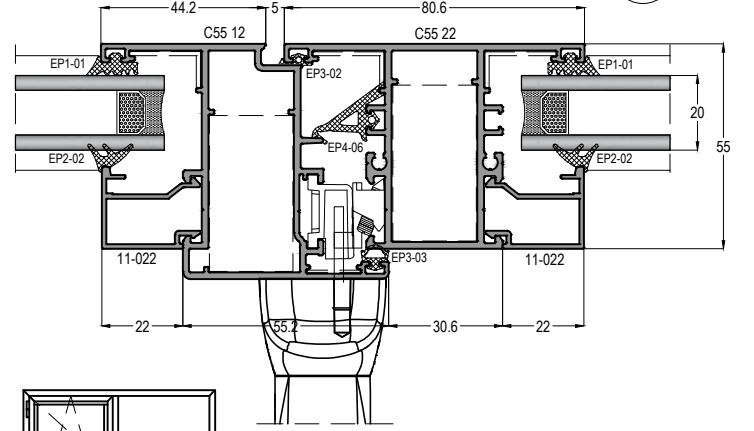

1a

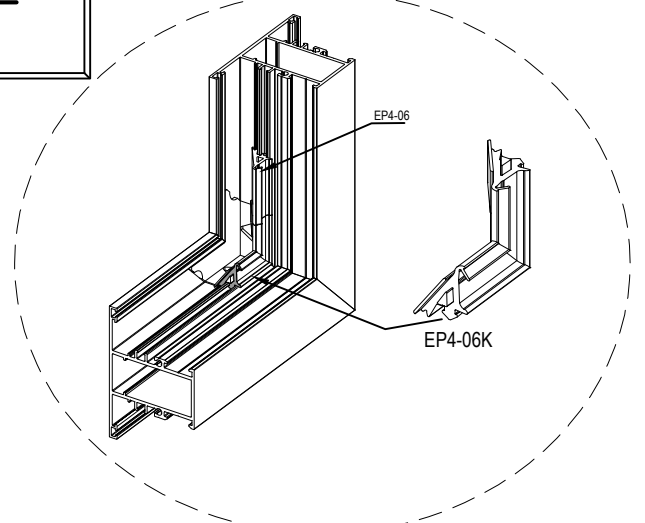
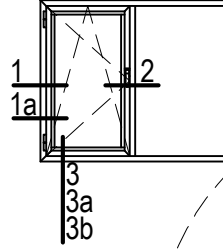
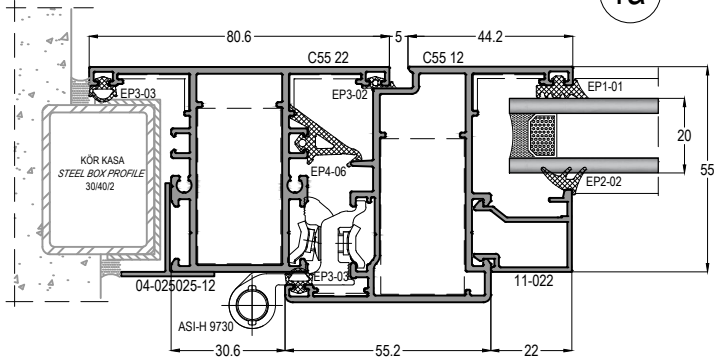

3

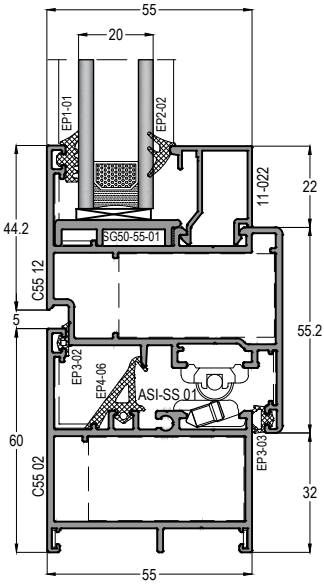

3a

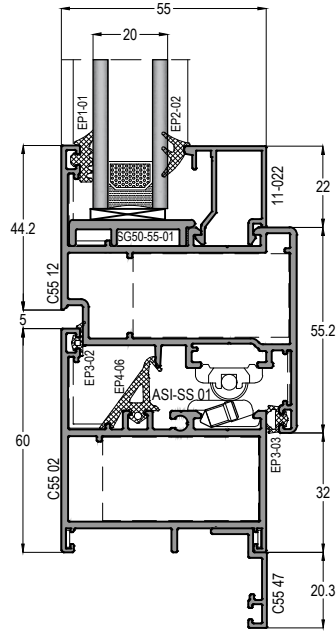

3b

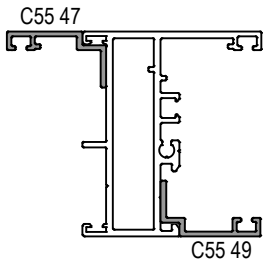
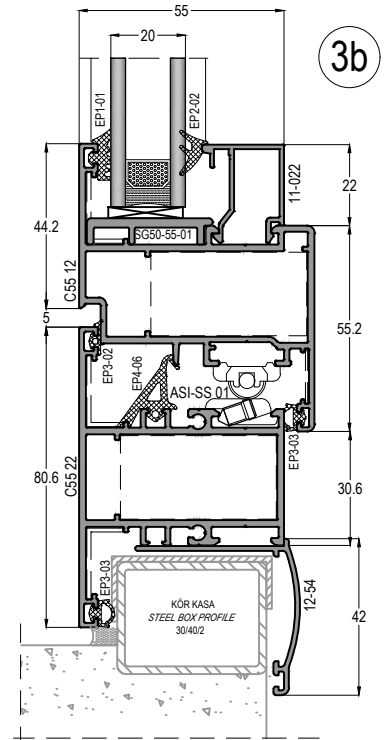

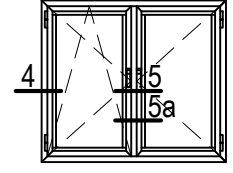
PENCERE AÇILIM DETAYLARI
WINDOW OPENING DETAILS

4

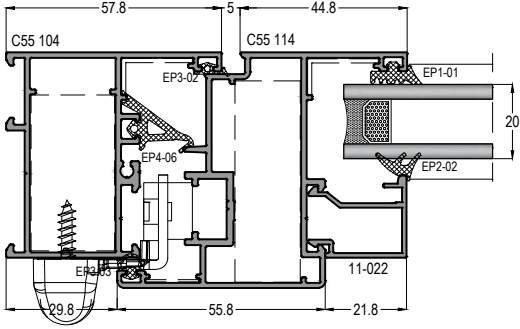

5

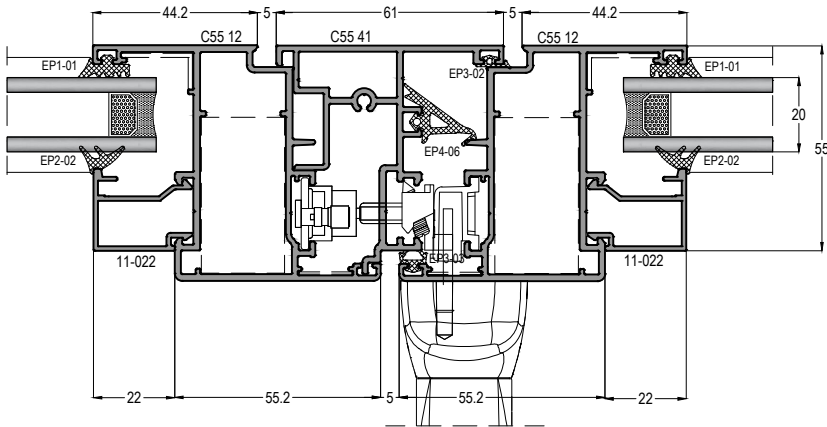

5a

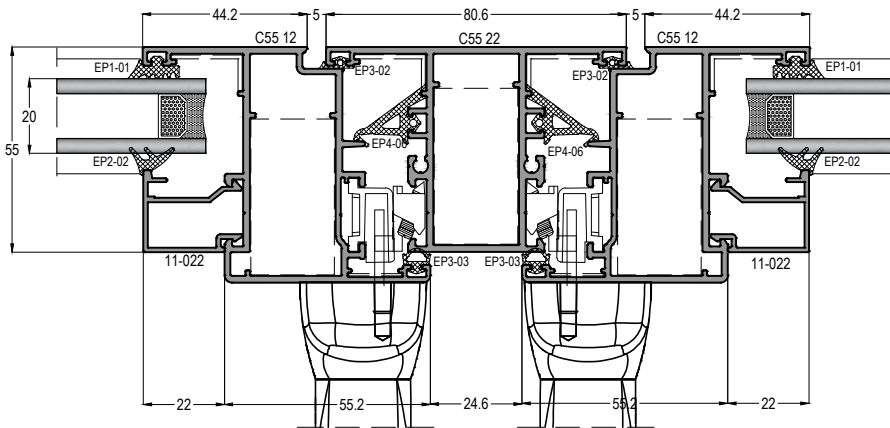

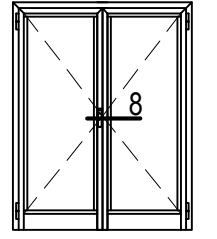
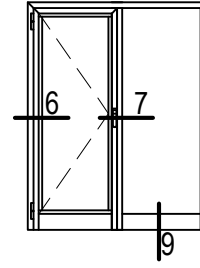
İÇE AÇILIR KAPI DETAYLARI
INNER OPENING DOOR DETAILS

6

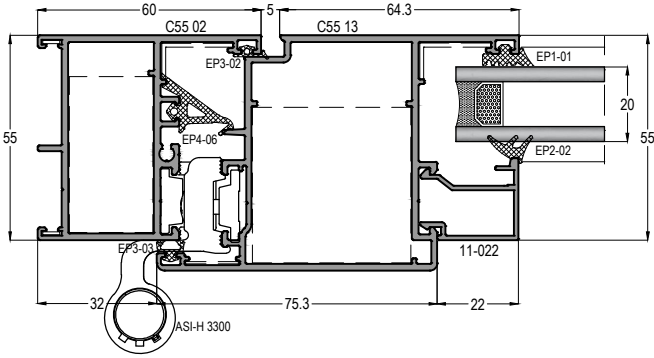

7

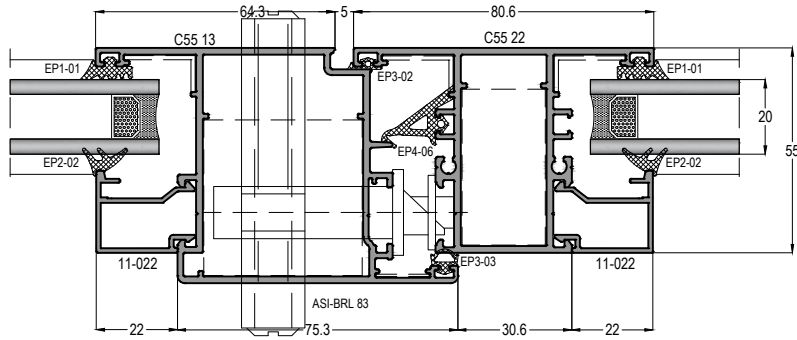

8

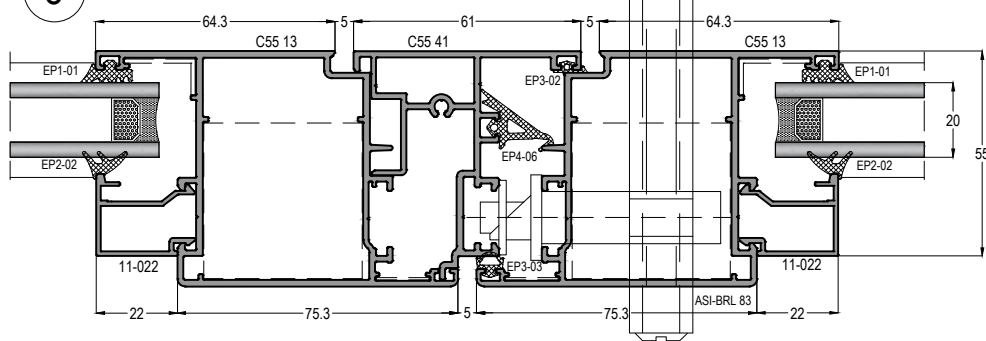

9

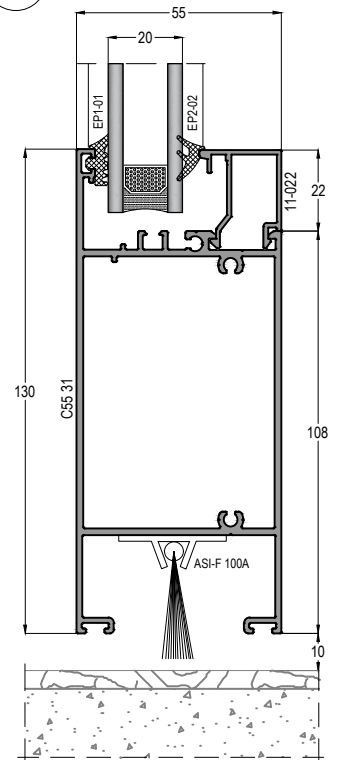

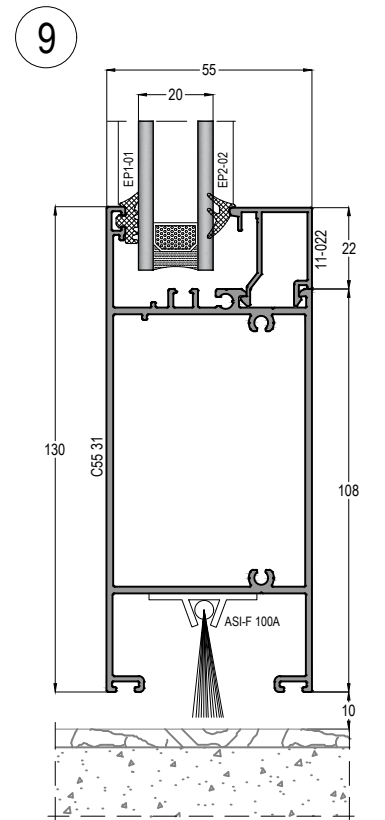
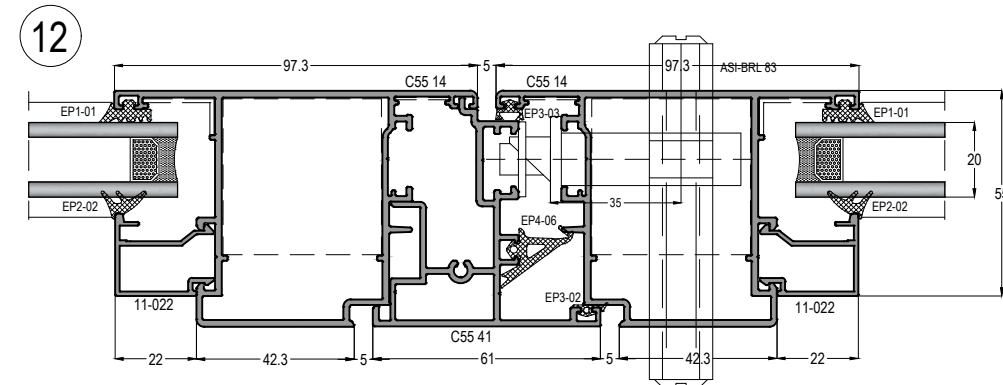
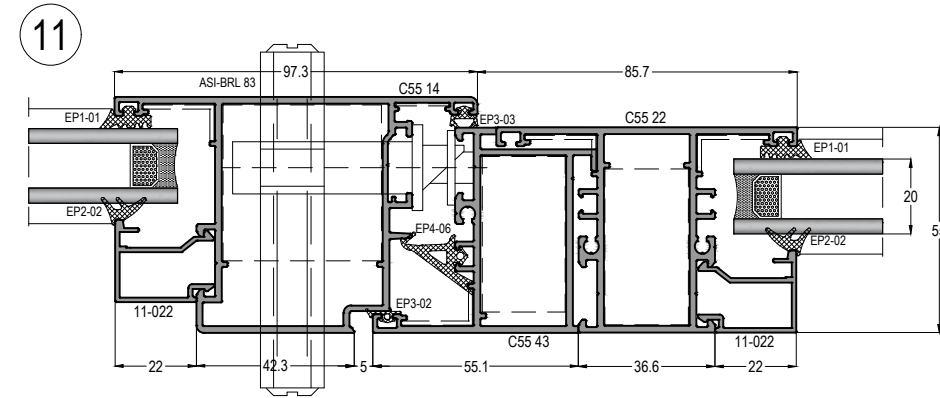
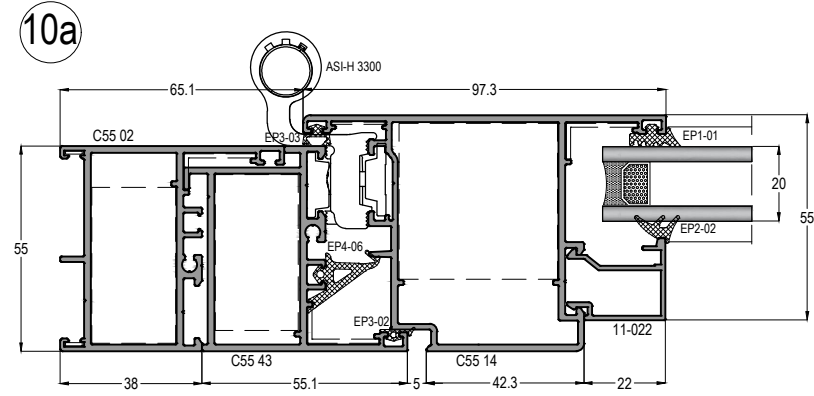
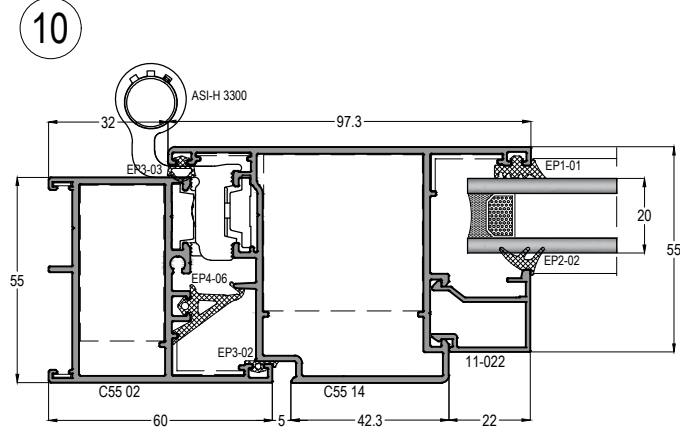
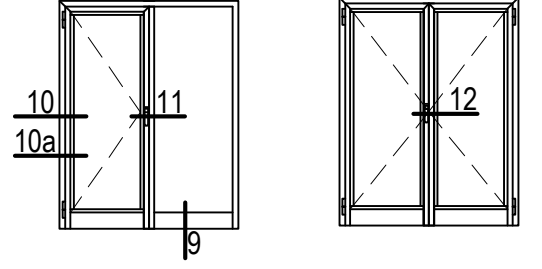
DİŞA AÇILIR KAPI DETAYLARI
OUTER OPENING DOOR DETAILS

C55

YALITIMSIZ KAPI-PENCERE SİSTEMİ
UNINSULATED WINDOW & DOOR SYSTEM

ASISTAL

ÇARPMA KAPI DETAYLARI SWING DOOR DETAILS

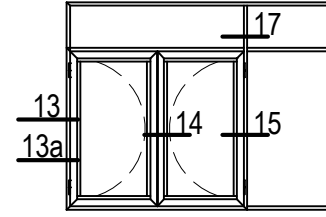

13

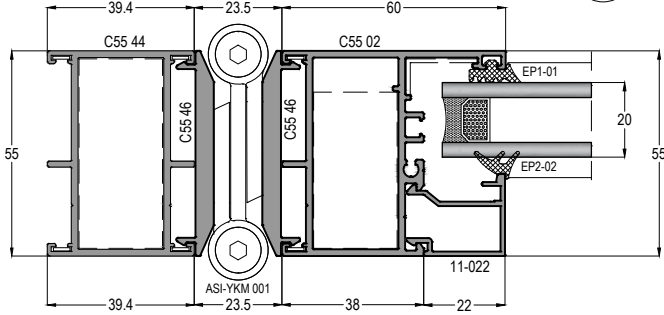

13a

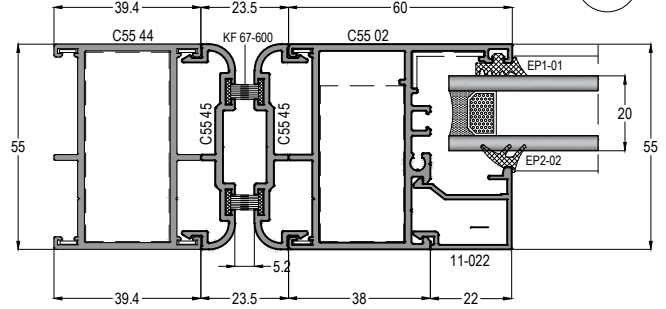

14

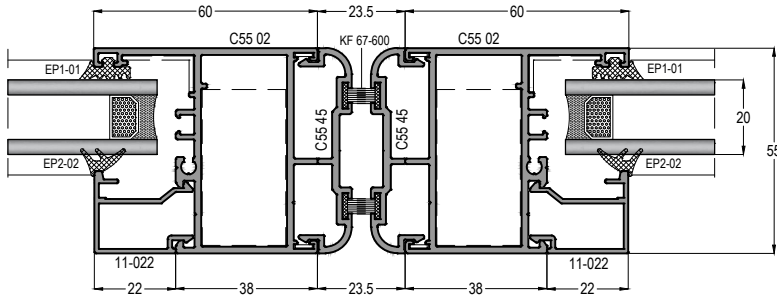

15

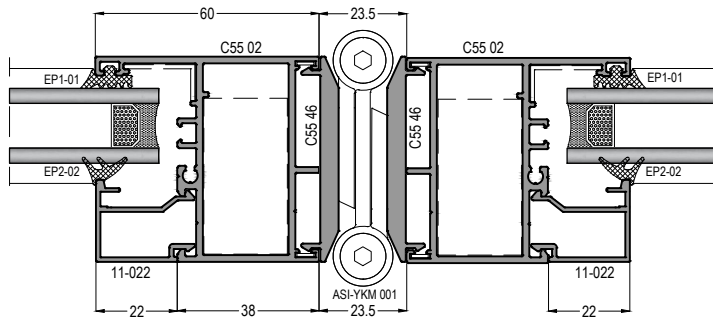

17

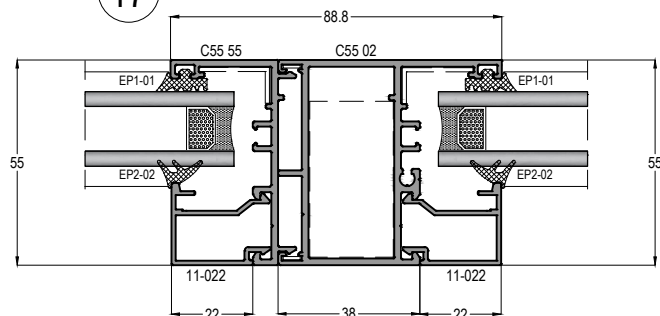

ö: 1/2

Profil ağırlıklarımız teorik olup; teslim anındaki tartımız geçerlidir.
Profile weights are theoretical and the weight at the time of delivery is valid.

C55

YALITIMSIZ KAPI-PENCERE SİSTEMİ
UNINSULATED WINDOW & DOOR SYSTEM

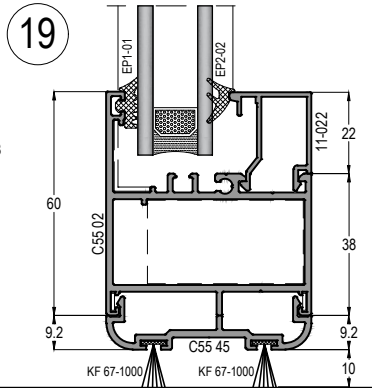
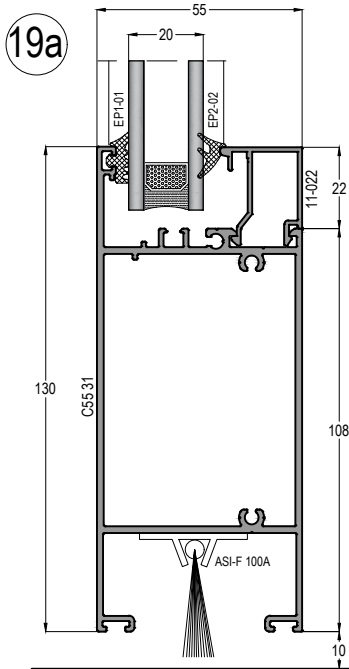
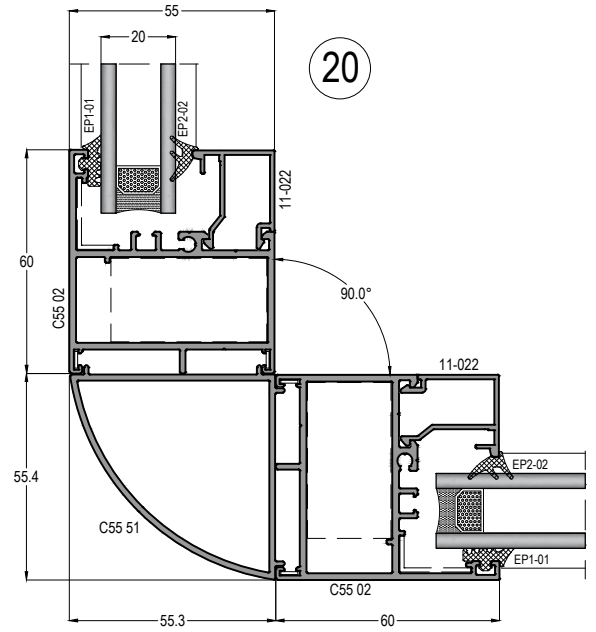
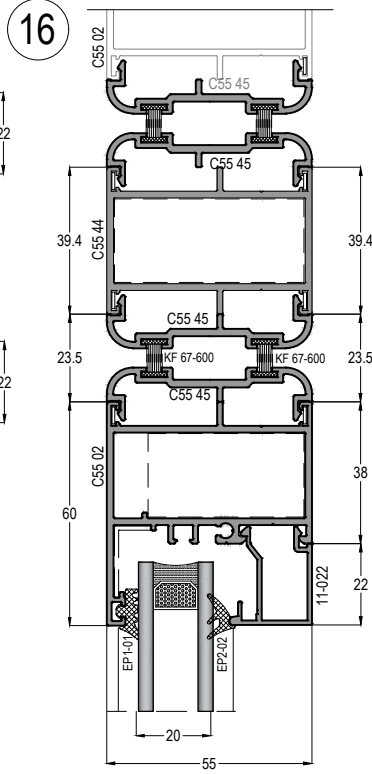
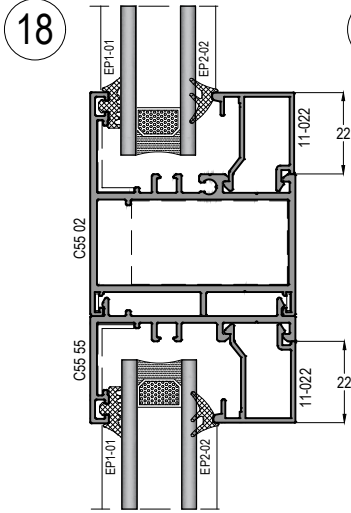
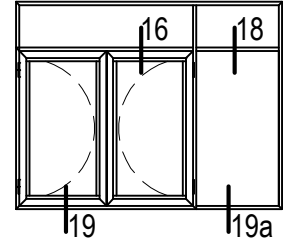
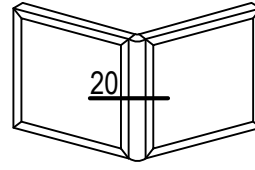

DIŞA AÇILIR PENCERE DETAYI

OUTER OPENING WINDOW DETAILS

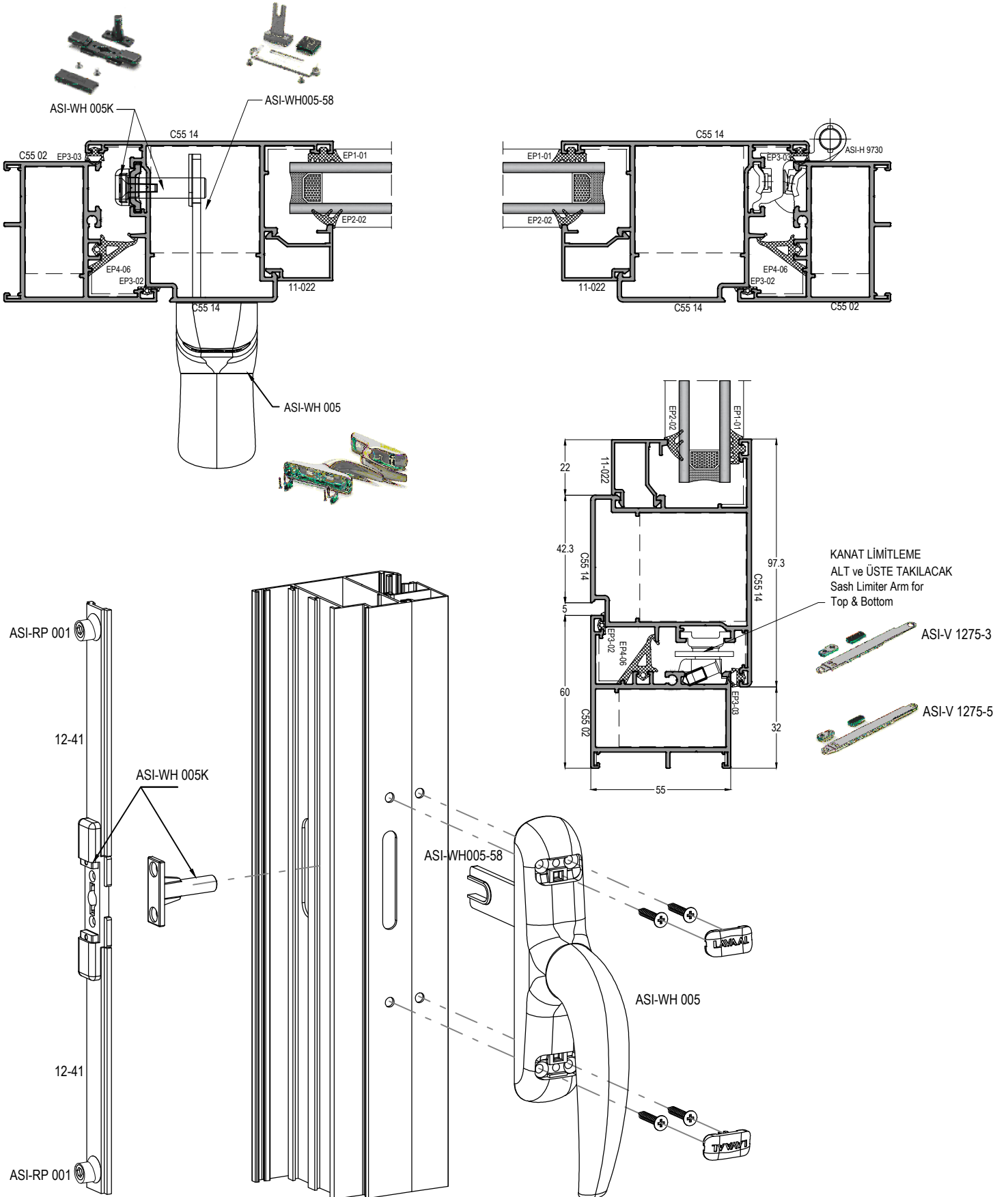

DIŞA AÇILIR PENCERE DETAYI

OUTER OPENING WINDOW DETAILS

THS62 17

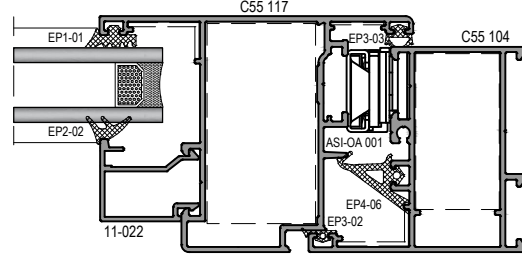
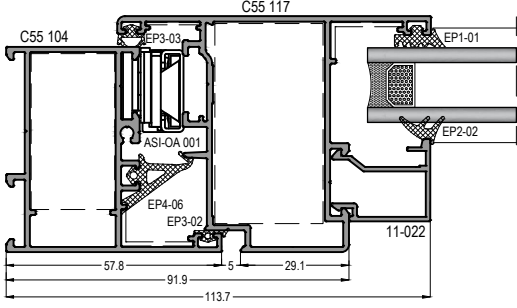

DIŞA AÇILIM PENCERE
OUT SIDE HUNG

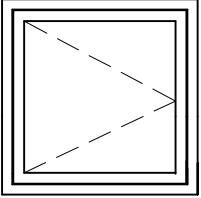

DIŞA VASİSTAS
OUT TOP HUNG

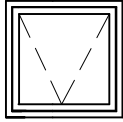
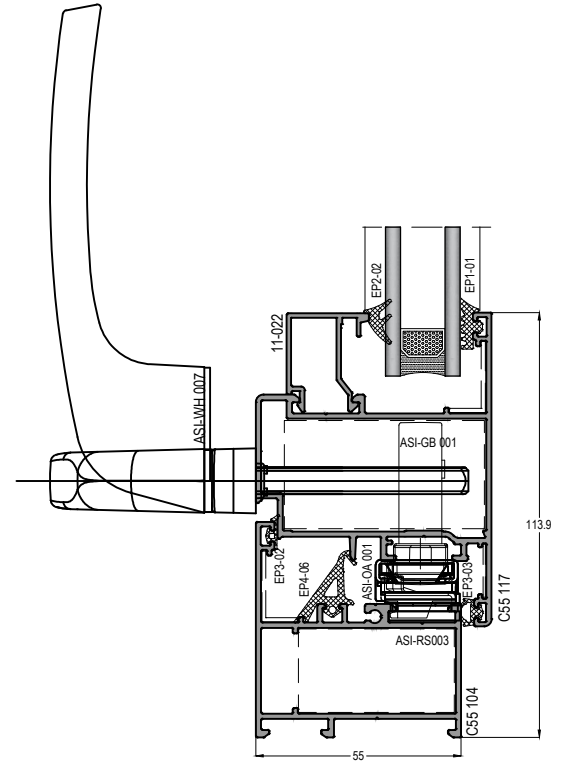
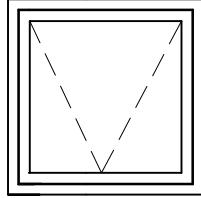

DIŞA AÇILIM VASİSTAS MAKAS SEÇİMİ
Top-Hung Arm Selections

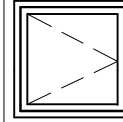

DIŞA AÇILIM PENCERE MAKAS SEÇİMİ
Side-Hung Arm Selections

AÇIKLAMA Description	KOD Item Code	Max. Açılır Açısı Max. Opening Angle	Max. Yükseklik Max. Height (mm)	Max. Genişlik Max. Width (mm)	Max. Ağırlık Max. Weight (Kg)	Makas Yüksekliği Arm Lenght (mm)	Max. Açılır Açısı Max. Opening Angle	Max. Yükseklik Max. Height (mm)	Max. Genişlik Max. Width (mm)	Max. Ağırlık Max. Weight (Kg)
DIŞA AÇILIM MAKAS-10" Eurogrove Arm	ASI-OA 001	50°	650	1500	50	259	50° 84° *	1500	650	35
DIŞA AÇILIM MAKAS-16" Eurogrove Arm	ASI-OA 002	30° 50°	800	1500	100 55	412	30° - 50° 90° *	1600	700	60 42
DIŞA AÇILIM MAKAS-22" Eurogrove Arm	ASI-OA 003	20° 45°	1500	1700	100 80	567	-	-	-	-
DIŞA AÇILIM MAKAS-28" Eurogrove Arm	ASI-OA 004	15°	2000	1700	100	711	-	-	-	-

C55

YALITIMSIZ KAPI-PENCERE SİSTEMİ
UNINSULATED WINDOW & DOOR SYSTEM

ASISTAL

KESİM ve MONTAJ
CUTTING & ASSEMBLY

C55

YALITIMSIZ KAPI-PENCERE SİSTEMİ
UNINSULATED WINDOW & DOOR SYSTEM

ASISTAL

KÖŞE VULKANİZE FİTİL MONTAJI
GASKET FOR CORNER MONTAGE

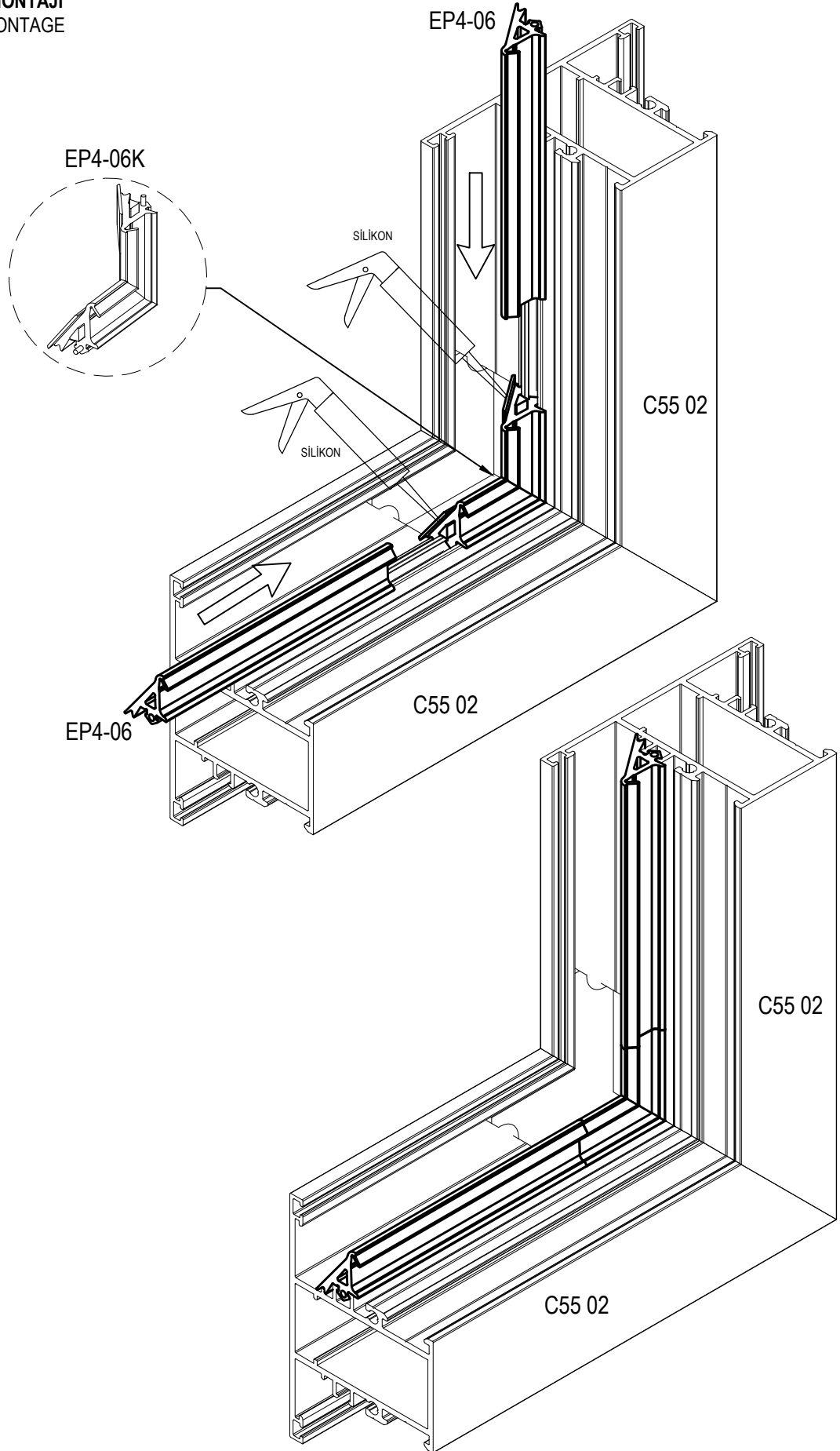

MULTI POINT SİSTEM (PVC KANALLI) ÇİFT EKSEN AÇILIM AKSESUAR TABLOSU

MULTI POINT SYSTEM TILT&TURN OPENING ACCESSORIES TABLE

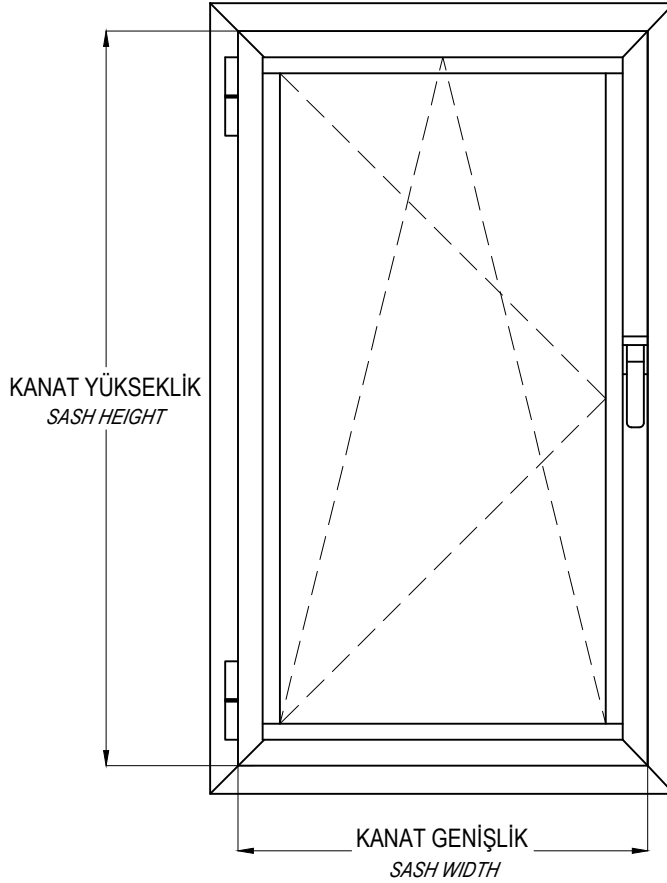

MULTI POINT (PVC KANALLI) KİLİTLEME AKSESUAR SEÇİM TABLOSU

MULTI POINT SYSTEM ACCESSORIES TABLE

YÜKSEKLİK- HEIGHT	GENİŞLİK - WIDTH				
	400-650mm	600-850mm	850-1100mm	1100-1350mm	1350mm-1600mm
450-700 mm	ASI-PVC TT 01	ASI-PVC TT 02	ASI-PVC TT 03	ASI-PVC TT 04	
700-1200 mm	ASI-PVC TT 05	ASI-PVC TT 06	ASI-PVC TT 07	ASI-PVC TT 08	ASI-PVC TT 09
1200-1400 mm	ASI-PVC TT 10	ASI-PVC TT 11	ASI-PVC TT 12	ASI-PVC TT 013	ASI-PVC TT 14
1400-1700 mm	ASI-PVC TT 15	ASI-PVC TT 16	ASI-PVC TT 017	ASI-PVC TT 18	ASI-PVC TT 19
1700-2400 mm	ASI-PVC TT 20	ASI-PVC TT 21	ASI-PVC TT 22	ASI-PVC TT 23	ASI-PVC TT 24

C55

YALITIMSIZ KAPI-PENCERE SİSTEMİ
UNINSULATED WINDOW & DOOR SYSTEM



MULTI POINT SİSTEM (PVC KANALLI) TEK EKSEN AÇILIM AKSESUARLARI

MULTI POINT SYSTEM SINGLE OPENING ACCESSORIES

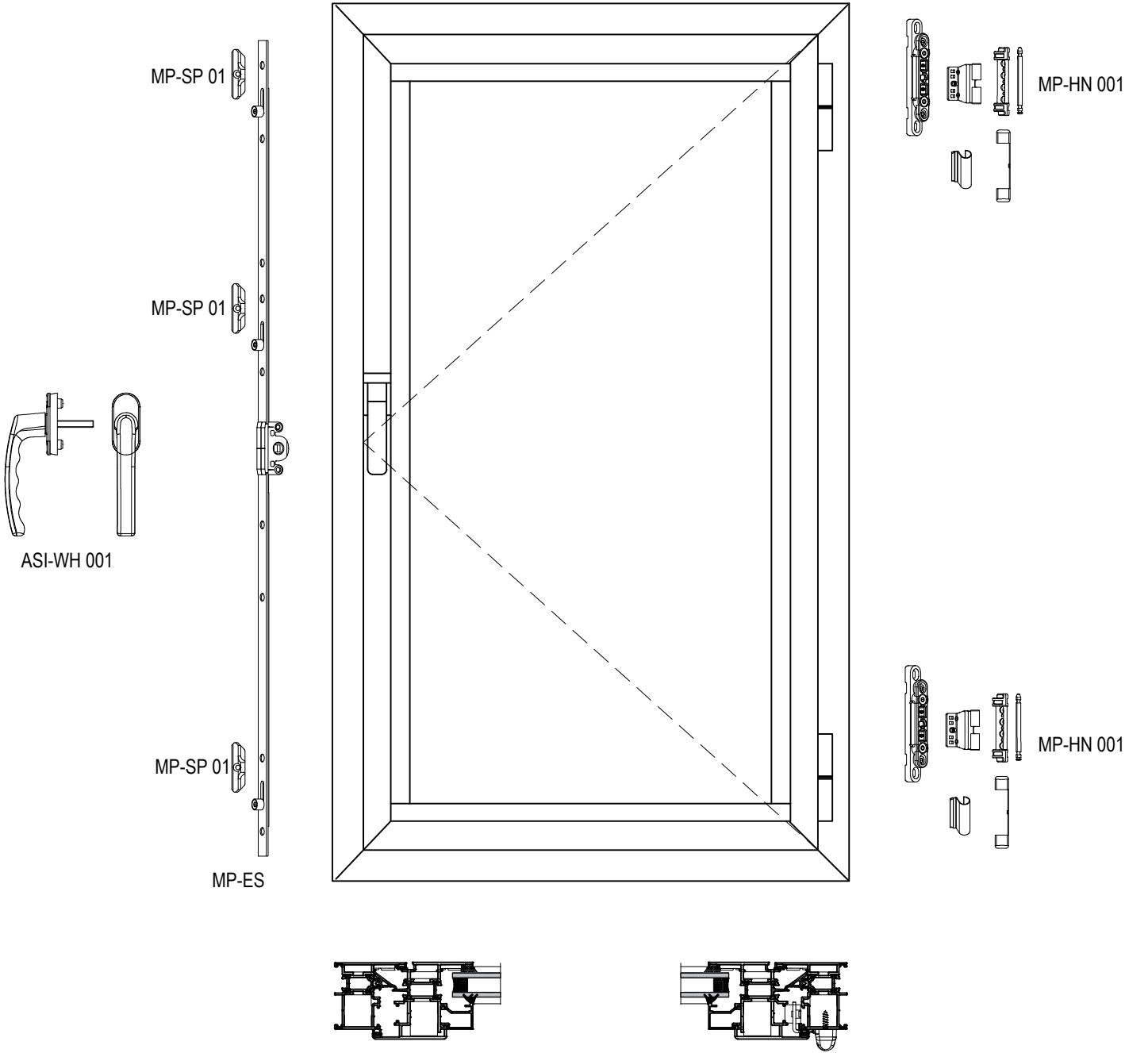

TEK KANAT AÇILIM KESİM ÖLÇÜLERİ SINGLE SASH CUTTING SIZES

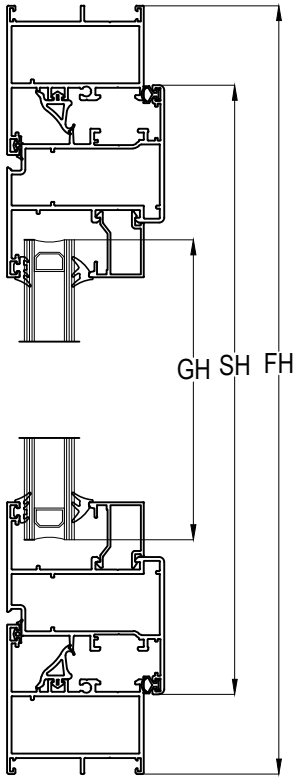
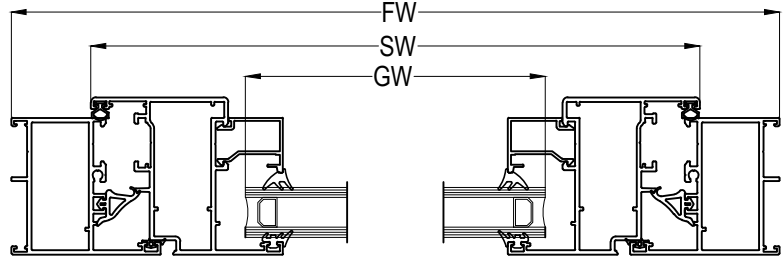
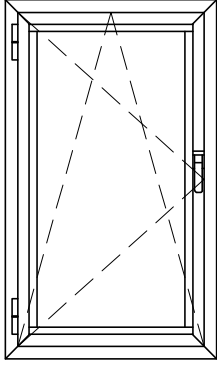

FW= KASA GENİŞLİĞİ / FRAME WIDTH

SW= KANAT GENİŞLİĞİ / SASH WIDTH

GW= CAM GENİŞLİĞİ / GLASS WIDTH

FH= KASA YÜKSEKLİĞİ / FRAME HEIGHT

SH= KANAT YÜKSEKLİĞİ / SASH HEIGHT

GH= CAM YÜKSEKLİĞİ / GLASS HEIGHT

KASA PROFİLİ FRAME PROFILE	KANAT PROFİLİ SASH PROFILE	KESİM ÖLÇÜLERİ CUTTING SIZES
C55 01	C55 11	SW = FW - 40mm GW = SW - 96,4mm SH = FH - 40mm GH = SH - 96,4mm
C55 01	C55 12	SW = FW - 40mm GW = SW - 120,4mm SH = FH - 40mm GH = SH - 120,4mm
C55 01	C55 13 C55 14	SW = FW - 40mm GW = SW - 160,4mm SH = FH - 40mm GH = SH - 160,4mm
C55 01	C55 15	SW = FW - 40mm GW = SW - 186mm SH = FH - 40mm GH = SH - 186mm
C55 02	C55 11	SW = FW - 64mm GW = SW - 96,4mm SH = FH - 64mm GH = SH - 96,4mm
C55 02	C55 12	SW = FW - 64mm GW = SW - 120,4mm SH = FH - 64mm GH = SH - 120,4mm
C55 02	C55 13 C55 14	SW = FW - 64mm GW = SW - 160,4mm SH = FH - 64mm GH = SH - 160,4mm
C55 02	C55 15	SW = FW - 64mm GW = SW - 186mm SH = FH - 64mm GH = SH - 186mm

ÇİFT KANAT AÇILIM KESİM ÖLÇÜLERİ DOUBLE SASH CUTTING SIZES

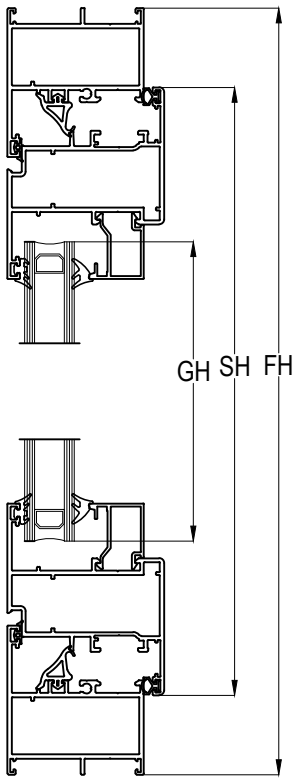
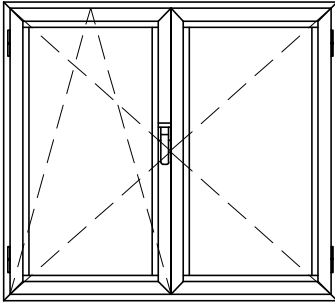
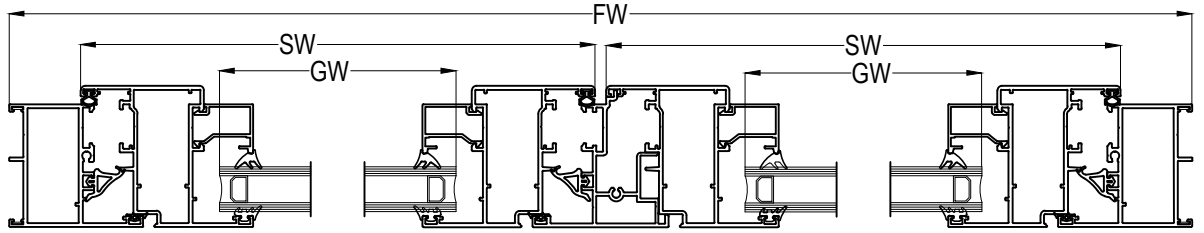

ADAPTÖR PROFİLİ
C55 41 = SH - 68,6mm

FW= KASA GENİŞLİĞİ / FRAME WIDTH
SW= KANAT GENİŞLİĞİ / SASH WIDTH
GW= CAM GENİŞLİĞİ / GLASS WIDTH

FH= KASA YÜKSEKLİĞİ / FRAME HEIGHT
SH= KANAT YÜKSEKLİĞİ / SASH HEIGHT
GH= CAM YÜKSEKLİĞİ / GLASS HEIGHT

KASA PROFİLİ FRAME PROFILE	KANAT PROFİLİ SASH PROFILE	KESİM ÖLÇÜLERİ CUTTING SIZES
C55 01	C55 11	SW = FW / 2 - 22,5mm GW = SW - 96,4mm SH = FH - 40mm GH = SH - 96,4mm
C55 01	C55 12	SW = FW / 2 - 22,5mm GW = SW - 120,4mm SH = FH - 40mm GH = SH - 120,4mm
C55 01	C55 13 C55 14	SW = FW / 2 - 22,5mm GW = SW - 160,4mm SH = FH - 40mm GH = SH - 160,4mm
C55 01	C55 15	SW = FW / 2 - 22,5mm GW = SW - 186mm SH = FH - 40mm GH = SH - 186mm
C55 02	C55 11	SW = FW / 2 - 34,5mm GW = SW - 96,4mm SH = FH - 64mm GH = SH - 96,4mm
C55 02	C55 12	SW = FW / 2 - 34,5mm GW = SW - 120,4mm SH = FH - 64mm GH = SH - 120,4mm
C55 02	C55 13 C55 14	SW = FW / 2 - 34,5mm GW = SW - 160,4mm SH = FH - 64mm GH = SH - 160,4mm
C55 02	C55 15	SW = FW / 2 - 34,5mm GW = SW - 186mm SH = FH - 64mm GH = SH - 186mm